



US00D690676S

(12) **United States Design Patent**  
**Daniel**

(10) **Patent No.:** **US D690,676 S**

(45) **Date of Patent:** **\*\* Oct. 1, 2013**

(54) **COMMUNICATION DEVICE WITH  
COMPARTMENT FOR ACCESS TO  
REPLACEABLE PARTS**

(74) *Attorney, Agent, or Firm* — Carol N. Green, Esq.

(76) Inventor: **Isaac S. Daniel**, Miramar, FL (US)

(57) **CLAIM**

The ornamental design for a communication device with compartment for access to replaceable parts, as shown and described.

(\*\*) Term: **14 Years**

(21) Appl. No.: **29/410,761**

**DESCRIPTION**

(22) Filed: **Jan. 11, 2012**

(51) **LOC (9) Cl.** ..... **14-03**

(52) **U.S. Cl.**

USPC ..... **D14/138 AD**; D14/138 R; D14/436

(58) **Field of Classification Search**

USPC ..... D14/138 G, 138 AD, 341, 346, 138 R,  
D14/138 AC, 496, 203.1, 203.4, 203.7, 248,  
D14/218, 436, 435; 455/575.1, 556.2, 575.3,  
455/575.4; D21/517; 379/433.01, 433.04;  
D10/65, 78, 104; D13/168

See application file for complete search history.

FIG. 1 is a front, bottom, left perspective view of the invention in the open position.

FIG. 2 is a front, bottom, left perspective view of the invention in the closed position.

FIG. 3 is a front, top, right perspective view of the invention in the open position.

FIG. 4 is a front, top, right perspective view of the invention in the closed position.

FIG. 5 is a rear, top, left perspective view of the invention in the open position.

FIG. 6 is a rear, top, left perspective view of the invention in the closed position.

FIG. 7 is a front view of the invention in the open position.

FIG. 8 is a front view of the invention in the closed position.

FIG. 9 is a rear view of the invention in the open position.

FIG. 10 is a rear view of the invention in the closed position.

FIG. 11 is a right side view of the invention in the open position.

FIG. 12 is a right side view of the invention in the closed position.

FIG. 13 is a left side view of the invention in the open position.

FIG. 14 is a left side view of the invention in the closed position.

FIG. 15 is a top plan view of the invention; and,

FIG. 16 is a bottom plan view of the invention.

The broken lines showing displayed information in FIGS. 1 and 2 are directed to environment and are for illustrative purposes only, forming no part of the claimed design.

(56) **References Cited**

**U.S. PATENT DOCUMENTS**

D287,253	S	*	12/1986	Satake	.....	D18/12
5,563,400	A	*	10/1996	Le Roux	.....	235/486
5,661,632	A	*	8/1997	Register	.....	361/679.3
5,677,524	A	*	10/1997	Haghiri-Tehrani	.....	235/492
D431,568	S	*	10/2000	Chan et al.	.....	D14/436
D445,096	S	*	7/2001	Wallace	.....	D14/436
D460,453	S	*	7/2002	Homma et al.	.....	D14/435
6,427,078	B1	*	7/2002	Wilska et al.	.....	455/550.1
6,724,370	B2	*	4/2004	Dutta et al.	.....	345/169

(Continued)

**OTHER PUBLICATIONS**

Motorola XT701 telephone, announced Dec. 2009, [online], [site visited May 01, 2013]. Available from Internet, <URL: [http://www.gsmarena.com/motorola\\_xt701-3071.php](http://www.gsmarena.com/motorola_xt701-3071.php)>.\*

*Primary Examiner* — Jeffrey D Asch

**1 Claim, 7 Drawing Sheets**

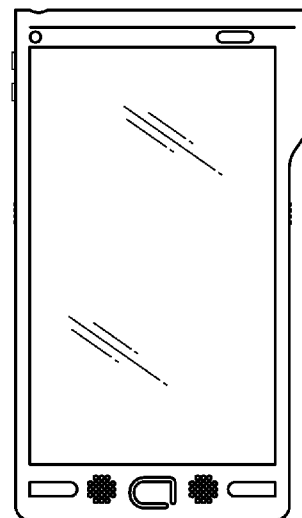
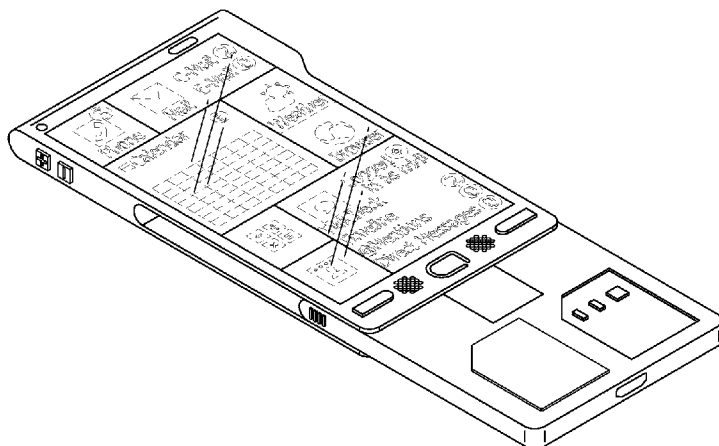

(56)

References Cited

U.S. PATENT DOCUMENTS

D528,097	S *	9/2006	Kim	.....	D14/138 G
7,233,489	B2 *	6/2007	Toyama et al.	.....	361/679.31
D551,647	S *	9/2007	Kim et al.	.....	D14/138 AD
D594,863	S *	6/2009	Ichise et al.	.....	D14/345
D613,722	S *	4/2010	Kaneta	.....	D14/138 G
D614,184	S *	4/2010	Daniel	.....	D14/346
D622,692	S *	8/2010	McWilliam et al.	.....	D14/138 G
7,822,446	B2 *	10/2010	Vatanparast et al.	.....	455/575.4
D628,997	S *	12/2010	Daniel	.....	D14/341
D646,661	S *	10/2011	Kim	.....	D14/138 AD
D647,498	S *	10/2011	Lee et al.	.....	D14/138 G
D654,902	S *	2/2012	Chung	.....	D14/138 AD
D676,008	S *	2/2013	Park et al.	.....	D14/138 G
D679,269	S *	4/2013	Fahlgren et al.	.....	D14/248
2005/0039027	A1 *	2/2005	Shapiro	.....	713/186
2008/0148059	A1 *	6/2008	Shapiro	.....	713/186
2009/0137293	A1 *	5/2009	Yoo et al.	.....	455/575.4

\* cited by examiner

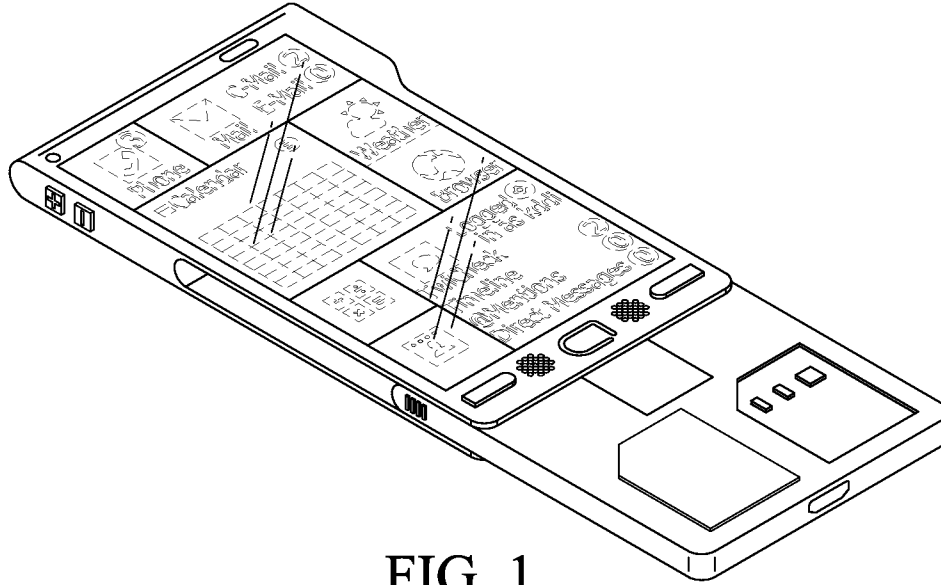

FIG. 1

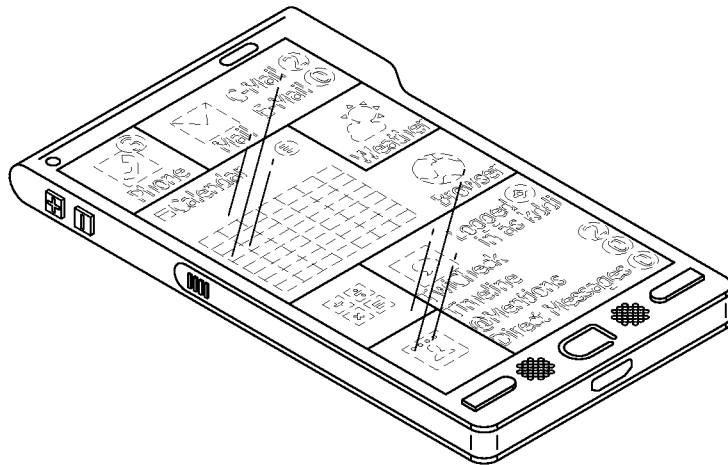

FIG. 2

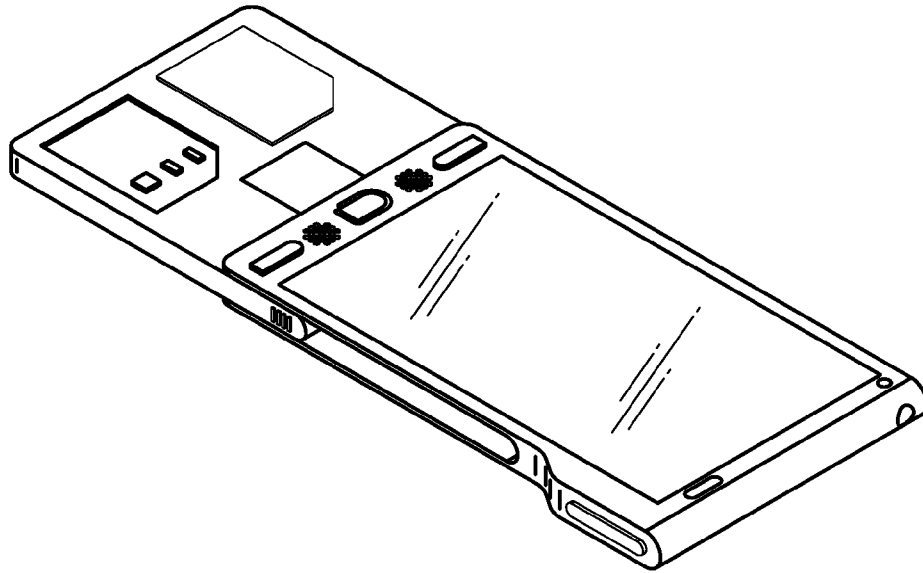

FIG. 3

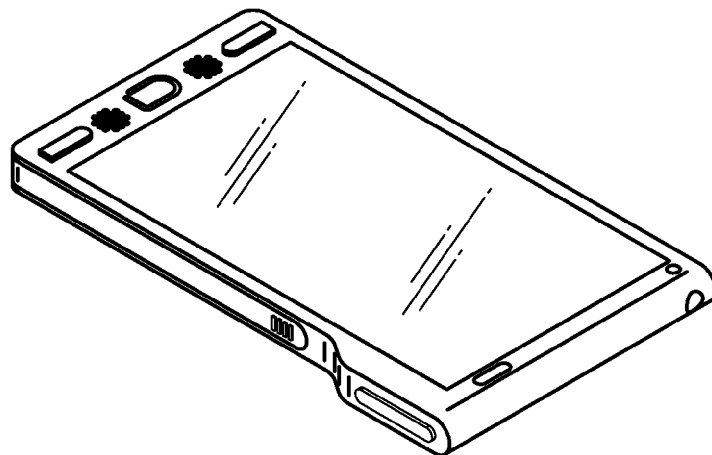

FIG. 4

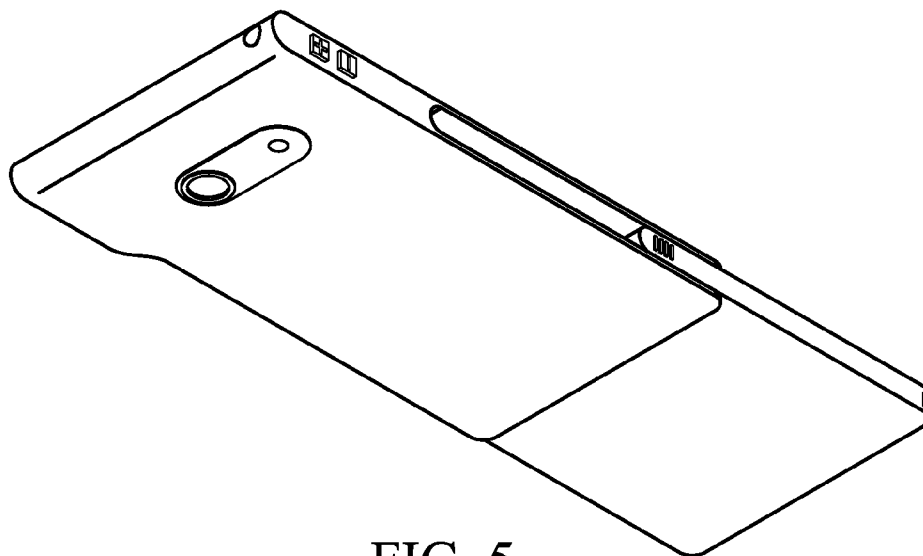

FIG. 5

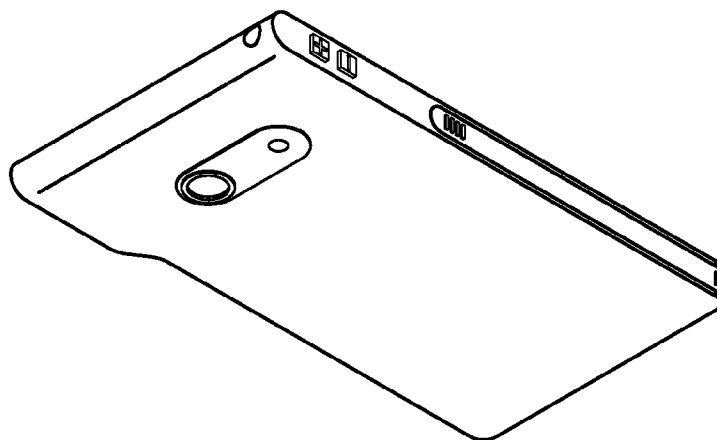

FIG. 6

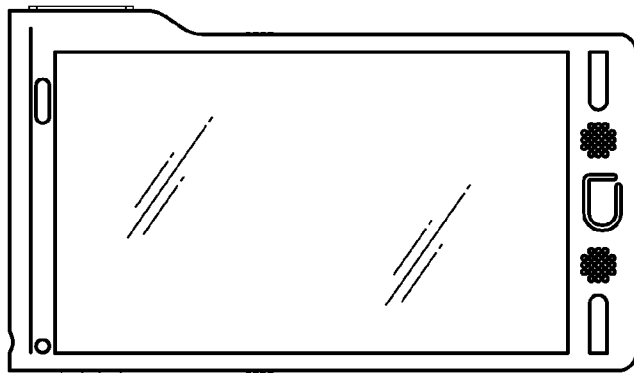

FIG. 8

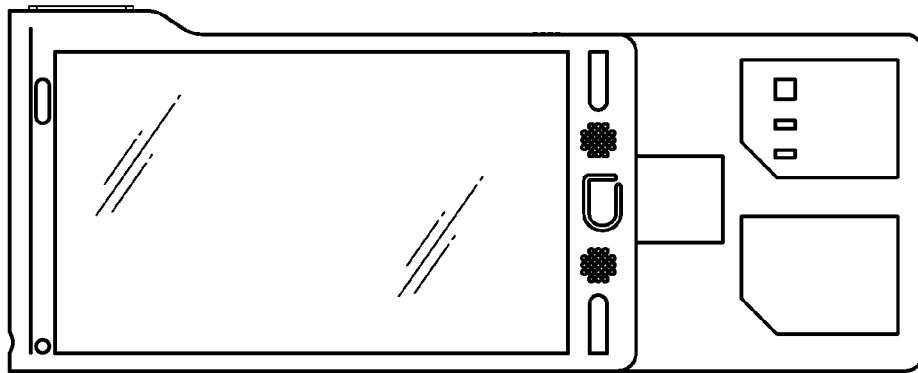

FIG. 7

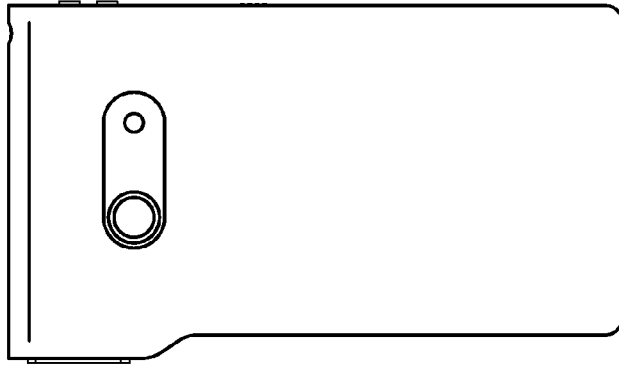

FIG. 10

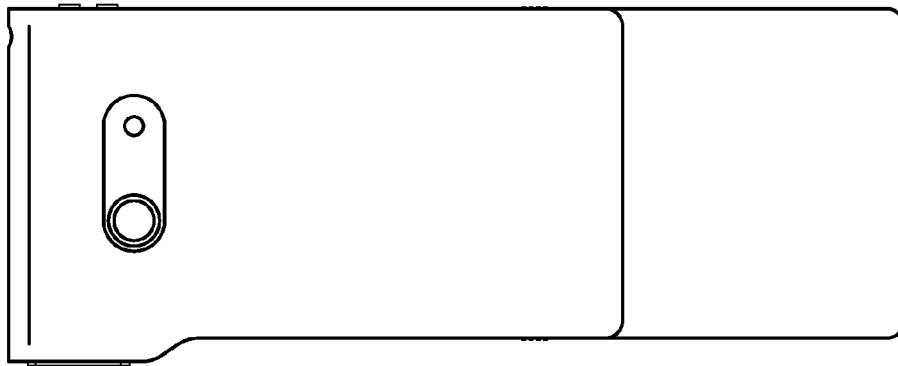

FIG. 9



FIG. 14

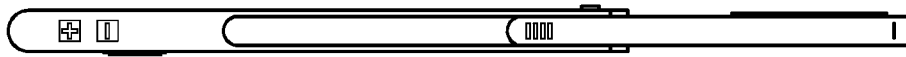

FIG. 13

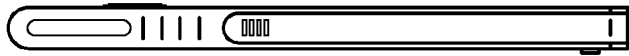

FIG. 12

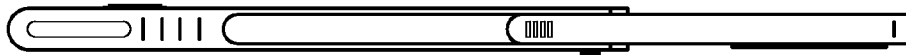

FIG. 11





FIG. 15



FIG. 16