



(12) **United States Design Patent**  
**Takahata**

(10) **Patent No.:** **US D752,011 S**  
(45) **Date of Patent:** **\*\* Mar. 22, 2016**

- (54) **INTERPHONE**
- (71) Applicant: **AIPHONE CO., LTD.**, Nagoya-Shi (JP)
- (72) Inventor: **Kotaro Takahata**, Nagoya (JP)
- (73) Assignee: **Airphone Co., Ltd.**, Nagoya-Shi (JP)
- (\*\*) Term: **14 Years**
- (21) Appl. No.: **29/502,802**
- (22) Filed: **Sep. 19, 2014**

**Related U.S. Application Data**

- (62) Division of application No. 29/432,262, filed on Sep. 14, 2012, now Pat. No. Des. 717,761.

**Foreign Application Priority Data**

- Mar. 28, 2012 (JP) ..... 2012-007133
- Mar. 28, 2012 (JP) ..... 2012-007134
- Mar. 28, 2012 (JP) ..... 2012-007135
- Mar. 28, 2012 (JP) ..... 2012-007136
- Aug. 27, 2012 (JP) ..... 2012-020469
- Aug. 27, 2012 (JP) ..... 2012-020470
- Aug. 27, 2012 (JP) ..... 2012-020471

(51) **LOC (10) Cl.** ..... **14-01**

(52) **U.S. Cl.**  
USPC ..... **D14/159; D14/142**

(58) **Field of Classification Search**  
USPC ..... D14/130, 140, 140.3, 142, 147-151,  
D14/329, 330, 434, 447, 241, 251, 253,  
D14/138 AD, 138 G, 159, 218, 247, 455;  
D13/107, 108; 379/428.01-428.04,  
379/440, 446; 320/110, 113-115  
CPC ..... H04M 1/23; H04M 1/02; H04M 1/0202;  
H01H 9/0235

See application file for complete search history.

(56) **References Cited**

U.S. PATENT DOCUMENTS

|               |         |                   |       |         |
|---------------|---------|-------------------|-------|---------|
| 4,944,402 A * | 7/1990  | Wu                | ..... | 206/581 |
| D368,097 S    | 3/1996  | Heberling et al.  |       |         |
| D408,821 S    | 4/1999  | Takahashi         |       |         |
| D457,866 S    | 5/2002  | Matsui et al.     |       |         |
| D477,609 S    | 7/2003  | Heath et al.      |       |         |
| D496,031 S    | 9/2004  | Ma et al.         |       |         |
| D516,545 S    | 3/2006  | Lai               |       |         |
| D531,585 S    | 11/2006 | Weitgasser et al. |       |         |
| D531,588 S    | 11/2006 | Peh               |       |         |
| D531,993 S *  | 11/2006 | Choi et al.       | ..... | D14/218 |
| D532,779 S    | 11/2006 | Kim et al.        |       |         |
| D534,131 S    | 12/2006 | Ng et al.         |       |         |
| D534,501 S    | 1/2007  | Yao               |       |         |
| D541,275 S    | 4/2007  | Lai               |       |         |
| D546,837 S *  | 7/2007  | Yeo               | ..... | D14/496 |

(Continued)

FOREIGN PATENT DOCUMENTS

KR 30-0492580 5/2008

*Primary Examiner* — Carla Jobe Wright  
*Assistant Examiner* — Holly E Thurman  
(74) *Attorney, Agent, or Firm* — Burr & Brown, PLLC

(57) **CLAIM**  
The ornamental design for an interphone, as shown and described.

**DESCRIPTION**

FIG. 1 is a front elevational view of an interphone illustrating my new design;  
FIG. 2 is a rear elevational view thereof;  
FIG. 3 is a left side elevational view thereof;  
FIG. 4 is a right side elevational view thereof;  
FIG. 5 is a top plan view thereof;  
FIG. 6 is a bottom plan view thereof; and,  
FIG. 7 is a front perspective view thereof.  
The portions of the interphone shown in broken lines in the drawings depict unclaimed subject matter only and form no part of the claimed design.

**1 Claim, 7 Drawing Sheets**

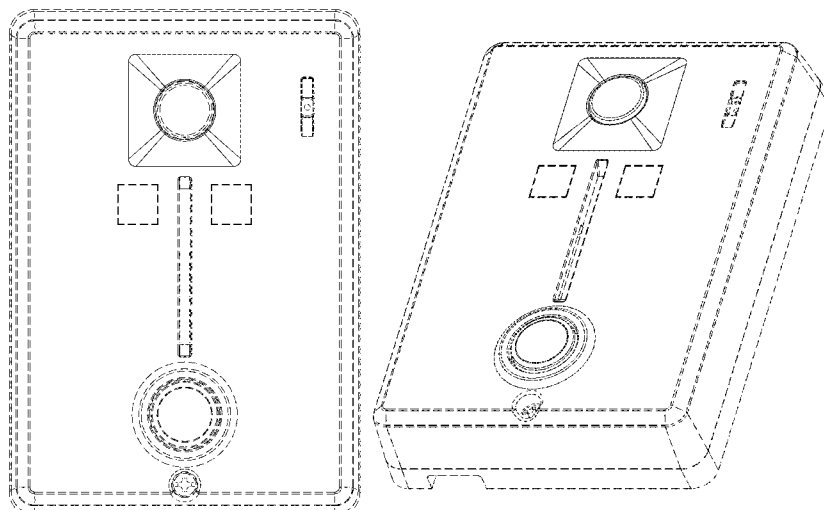

(56)

**References Cited**

U.S. PATENT DOCUMENTS

|              |         |                   |         |                 |         |                       |         |
|--------------|---------|-------------------|---------|-----------------|---------|-----------------------|---------|
| D558,619 S   | 1/2008  | Bloem             |         | D639,284 S *    | 6/2011  | Price et al. ....     | D14/247 |
| D559,202 S * | 1/2008  | Sim et al. ....   | D13/168 | D640,669 S      | 6/2011  | Cho et al.            |         |
| D569,819 S   | 5/2008  | Rinaldi et al.    |         | D645,848 S      | 9/2011  | Arnholt et al.        |         |
| D573,577 S * | 7/2008  | Huang .....       | D14/155 | D647,510 S      | 10/2011 | Maier et al.          |         |
| D577,713 S   | 9/2008  | Kim et al.        |         | D647,884 S      | 11/2011 | Moon et al.           |         |
| D578,993 S   | 10/2008 | Yamada et al.     |         | D650,365 S      | 12/2011 | McManigal et al.      |         |
| D583,776 S   | 12/2008 | Lacour et al.     |         | D653,240 S *    | 1/2012  | Wakata .....          | D14/218 |
| D588,574 S   | 3/2009  | Takahata          |         | D656,487 S *    | 3/2012  | Corsini et al. ....   | D14/218 |
| D590,730 S   | 4/2009  | Simard et al.     |         | D658,634 S *    | 5/2012  | Son et al. ....       | D14/218 |
| D595,260 S   | 6/2009  | Takahata          |         | D661,664 S *    | 6/2012  | Felegy et al. ....    | D13/168 |
| D598,893 S   | 8/2009  | Asai              |         | D661,690 S      | 6/2012  | Weitgasser            |         |
| D614,171 S * | 4/2010  | Son et al. ....   | D14/218 | D661,691 S      | 6/2012  | Weitgasser            |         |
| D619,105 S   | 7/2010  | Felegy et al.     |         | D663,288 S      | 7/2012  | Aquillano et al.      |         |
| D620,917 S   | 8/2010  | Hattori et al.    |         | D689,037 S      | 9/2013  | Sumi et al.           |         |
| D621,371 S   | 8/2010  | Sheppard et al.   |         | D691,097 S *    | 10/2013 | Lind et al. ....      | D13/164 |
| D626,942 S   | 11/2010 | Aquillano et al.  |         | D694,733 S *    | 12/2013 | Rodriguez et al. .... | D14/142 |
| D630,137 S * | 1/2011  | Noble et al. .... | D12/160 | D697,055 S      | 1/2014  | McManigal             |         |
| D633,478 S   | 3/2011  | Bolton            |         | D697,056 S      | 1/2014  | McManigal             |         |
| D636,371 S   | 4/2011  | Spielvogel et al. |         | D697,499 S      | 1/2014  | McManigal             |         |
| D636,761 S   | 4/2011  | Hansen et al.     |         | D714,740 S *    | 10/2014 | Corsini et al. ....   | D13/168 |
|              |         |                   |         | 2004/0224717 A1 | 11/2004 | Hertzberg et al.      |         |
|              |         |                   |         | 2007/0247376 A1 | 10/2007 | Kim et al.            |         |
|              |         |                   |         | 2009/0084147 A1 | 4/2009  | Mizutani et al.       |         |

\* cited by examiner

Fig.1

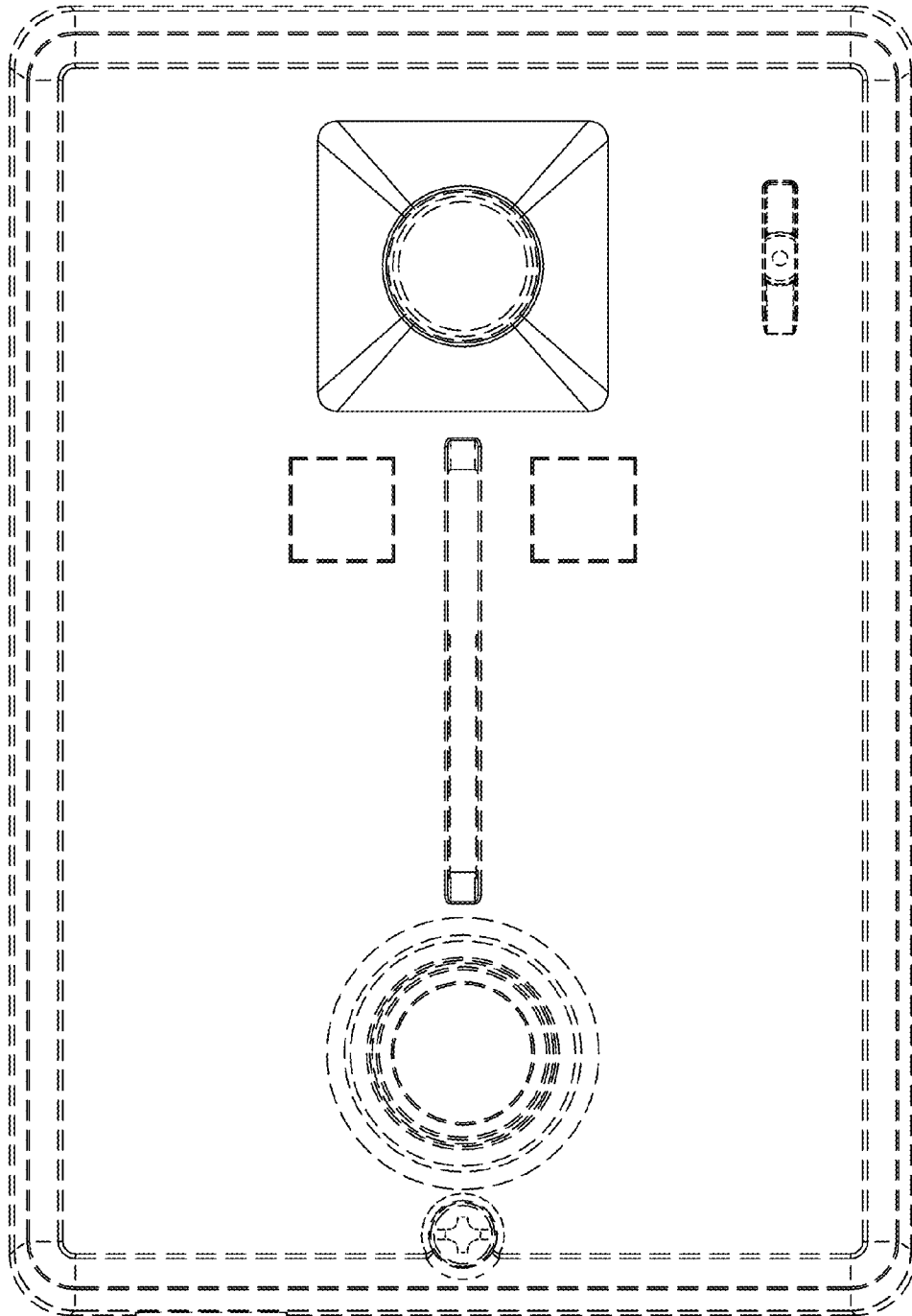

Fig.2

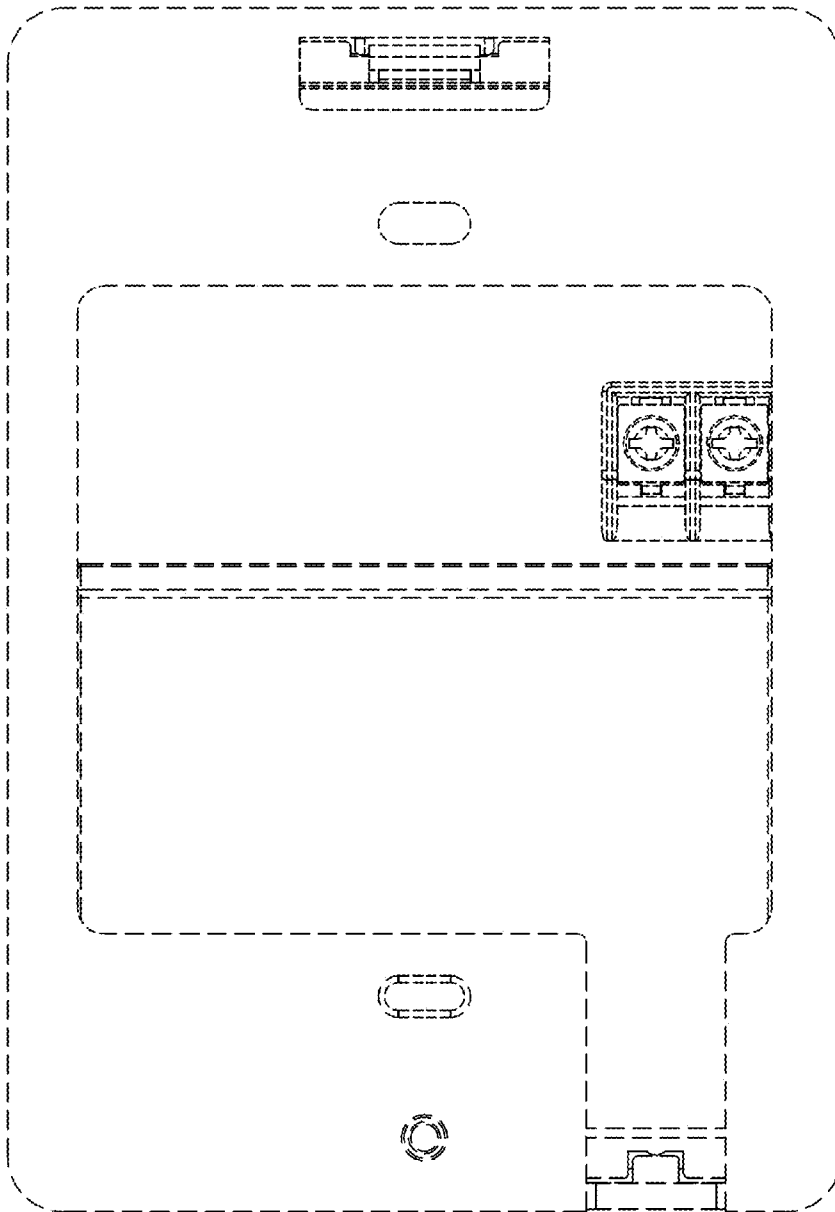

Fig.3

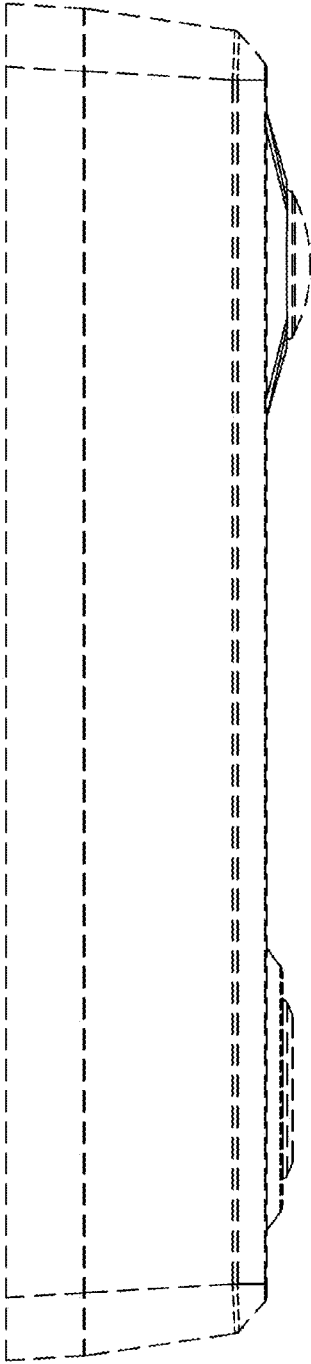

Fig.4

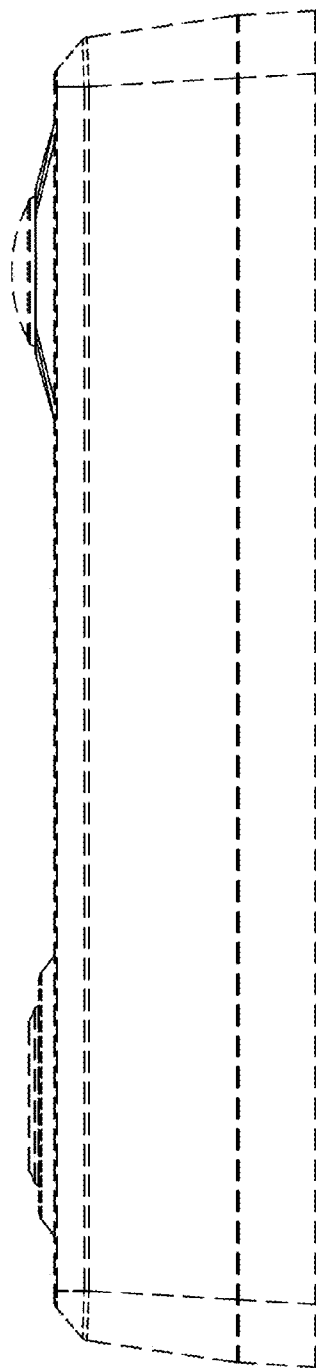

Fig.5

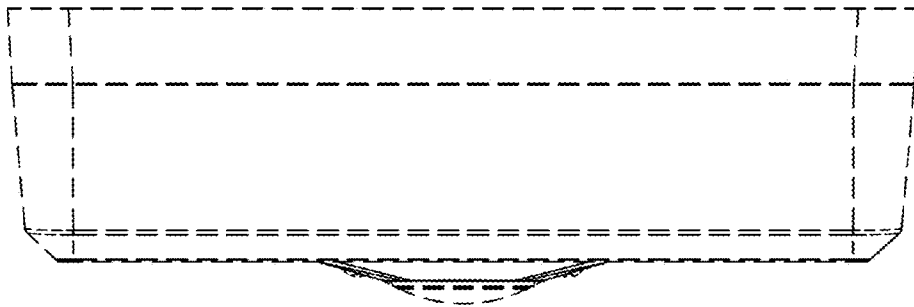

Fig.6

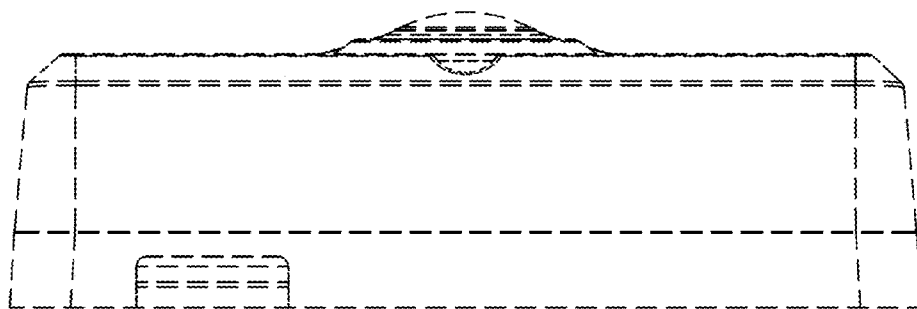



Fig.7

