



US00D599967S

(12) **United States Design Patent**  
**Blanc-Tailleur**

(10) **Patent No.:** **US D599,967 S**

(45) **Date of Patent:** **\*\* Sep. 8, 2009**

(54) **SWIMMING POOL CLEANER ROBOT**

(75) Inventor: **Philippe Blanc-Tailleur**, Toulouse (FR)

(73) Assignee: **Zodiac Pool Care Europe** (FR)

(\*\*) Term: **14 Years**

(21) Appl. No.: **29/312,042**

(22) Filed: **Sep. 26, 2008**

(30) **Foreign Application Priority Data**

Jun. 23, 2008 (EM) ..... 000956859-0001

(51) **LOC (9) Cl.** ..... **15-05**

(52) **U.S. Cl.** ..... **D32/1**

(58) **Field of Classification Search** ..... D32/1,

D32/15, 21; 15/1.7; 210/169, 416.2, 460

See application file for complete search history.

(56) **References Cited**

**U.S. PATENT DOCUMENTS**

5,001,800 A \* 3/1991 Parenti et al. .... 15/1.7

(Continued)

**FOREIGN PATENT DOCUMENTS**

EM	000313887-0001	3/2005
FR	963389	4/1997
FR	07/08993	12/2007
FR	07/08994	12/2007
FR	07/08995	12/2007
FR	07/08996	12/2007
FR	07/08997	12/2007
FR	07/08998	12/2007
FR	07/08999	12/2007
FR	07/09000	12/2007
FR	07/09001	12/2007
FR	07/09002	12/2007

FR	07/09003	12/2007
FR	08/01675	3/2008
FR	08/01676	3/2008
FR	08/04424	8/2008
WO	DM 039 680	12/1996
WO	DM 065 762	8/2004

*Primary Examiner*—T. Chase Nelson  
*Assistant Examiner*—Kathleen M Sims  
(74) *Attorney, Agent, or Firm*—Dean W. Russell; Michael A. Bertelson; Kilpatrick Stockton LLP

(57) **CLAIM**

The ornamental design for a swimming pool cleaner robot, as shown and described.

**DESCRIPTION**

FIG. 1 is a front view of the swimming pool cleaner robot showing my new design.

FIG. 2 is a back view of the new design for a swimming pool cleaner robot;

FIG. 3 is a top view of the new design for a swimming pool cleaner robot;

FIG. 4 is a right side view of the new design for a swimming pool cleaner robot;

FIG. 5 is a left side view of the new design for a swimming pool cleaner robot;

FIG. 6 is a front perspective view of the new design for a swimming pool cleaner robot; and,

FIG. 7 is a rear perspective view of the new design for a swimming pool cleaner robot.

Portions or features of the swimming pool cleaner robot not shown in the drawings form no part of the claimed design. Portions or features of the swimming pool cleaner robot shown in broken lines form no part of the claimed design.

**1 Claim, 7 Drawing Sheets**

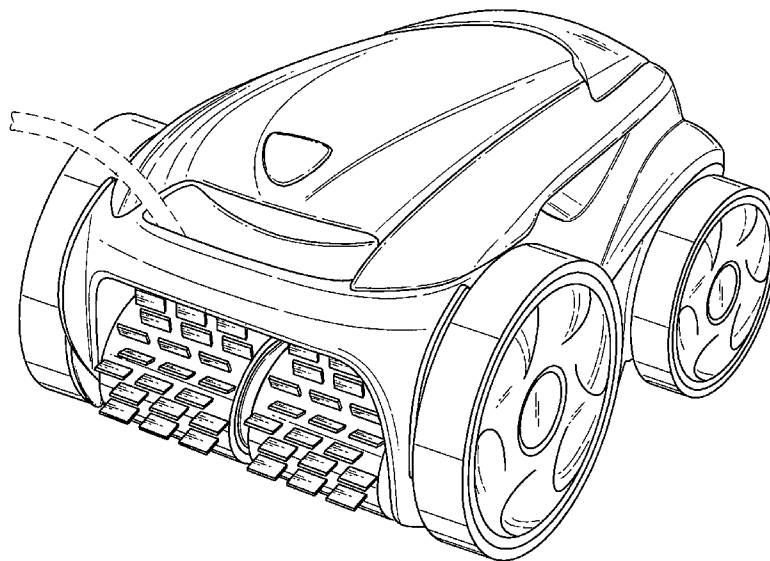

# US D599,967 S

Page 2

U.S. PATENT DOCUMENTS			
5,097,559	A *	3/1992	Brunt et al. .... 15/1.7
5,245,723	A *	9/1993	Sommer ..... 15/1.7
5,351,355	A	10/1994	Chiniara
5,507,058	A *	4/1996	Minami et al. .... 15/1.7
D373,230	S	8/1996	Sebor et al.
D376,450	S	12/1996	Campbell et al.
D384,782	S *	10/1997	Gefter ..... D32/21
D401,023	S *	11/1998	Sebor et al. .... D32/33
D408,104	S	4/1999	Adam
D417,322	S *	11/1999	Hollinger ..... D32/1
D418,640	S	1/2000	Veloskey et al.
D421,512	S *	3/2000	Campbell ..... D32/1
D433,545	S	11/2000	Hollinger et al.
6,212,725	B1	4/2001	Porat
D443,737	S	6/2001	Rief et al.
D444,280	S	6/2001	Rief et al.
D445,225	S	7/2001	Schaub
6,299,699	B1 *	10/2001	Porat et al. .... 134/6
D469,589	S	1/2003	Wichmann et al.
D471,330	S	3/2003	Campbell
6,627,074	B2	9/2003	Lincke
6,842,931	B2	1/2005	Porat et al.
6,954,960	B2	10/2005	Pichon
6,965,814	B2 *	11/2005	Hadari ..... 700/282
D526,101	S	8/2006	Blanc-Tailleux
D529,669	S	10/2006	Blanc-Tailleux
7,118,632	B2 *	10/2006	Sumonthee ..... 134/6
D575,915	S *	8/2008	Dreyer ..... D32/15
7,464,429	B2 *	12/2008	Stoltz ..... 15/1.7
2002/0104790	A1	8/2002	Lincke
2004/0025268	A1	2/2004	Porat et al.
2005/0262652	A1	12/2005	Sumonthee

\* cited by examiner

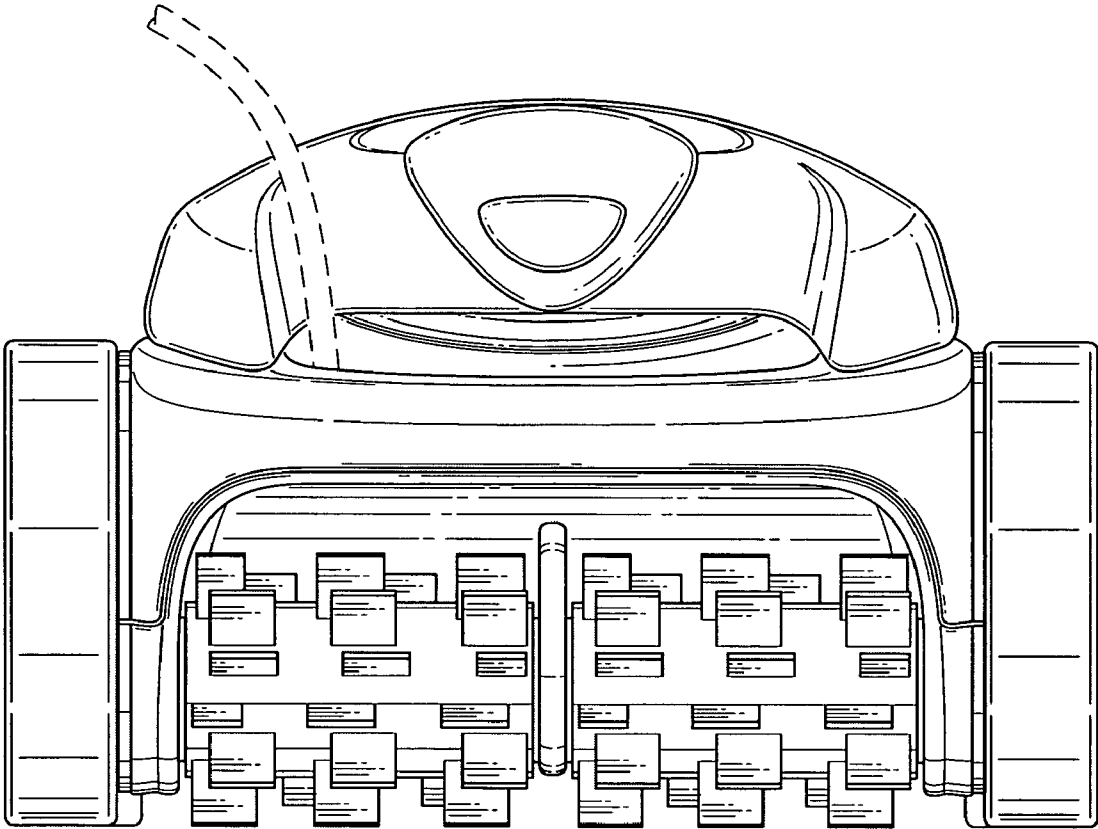

FIG. 1

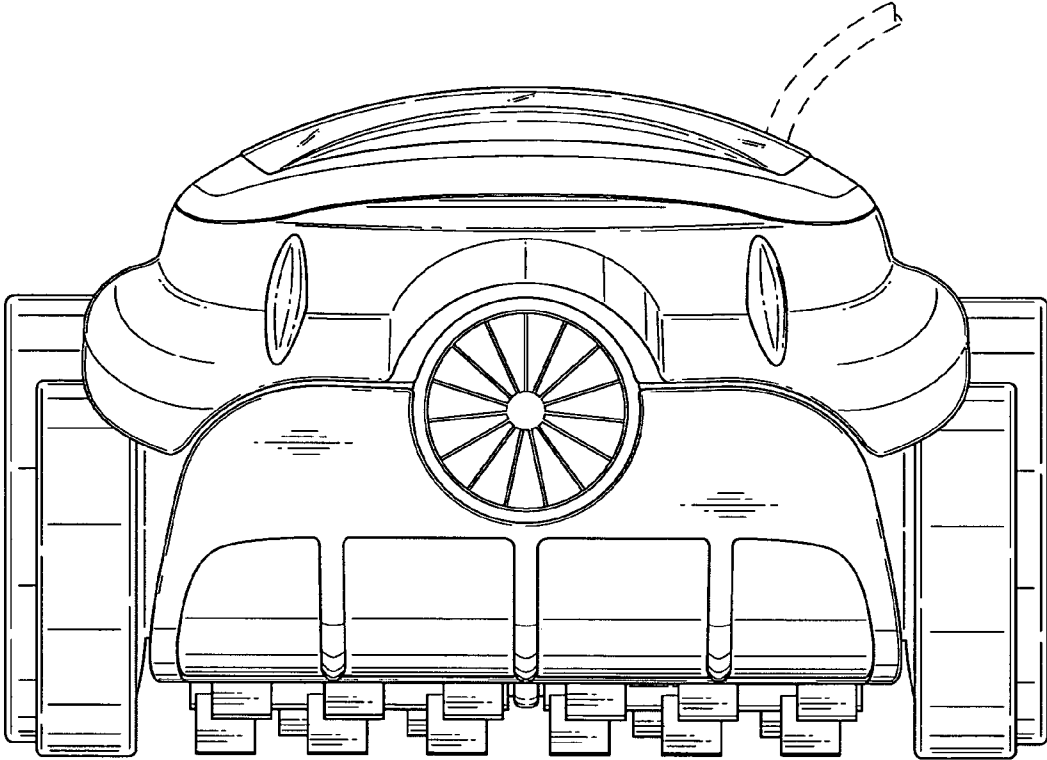

FIG. 2

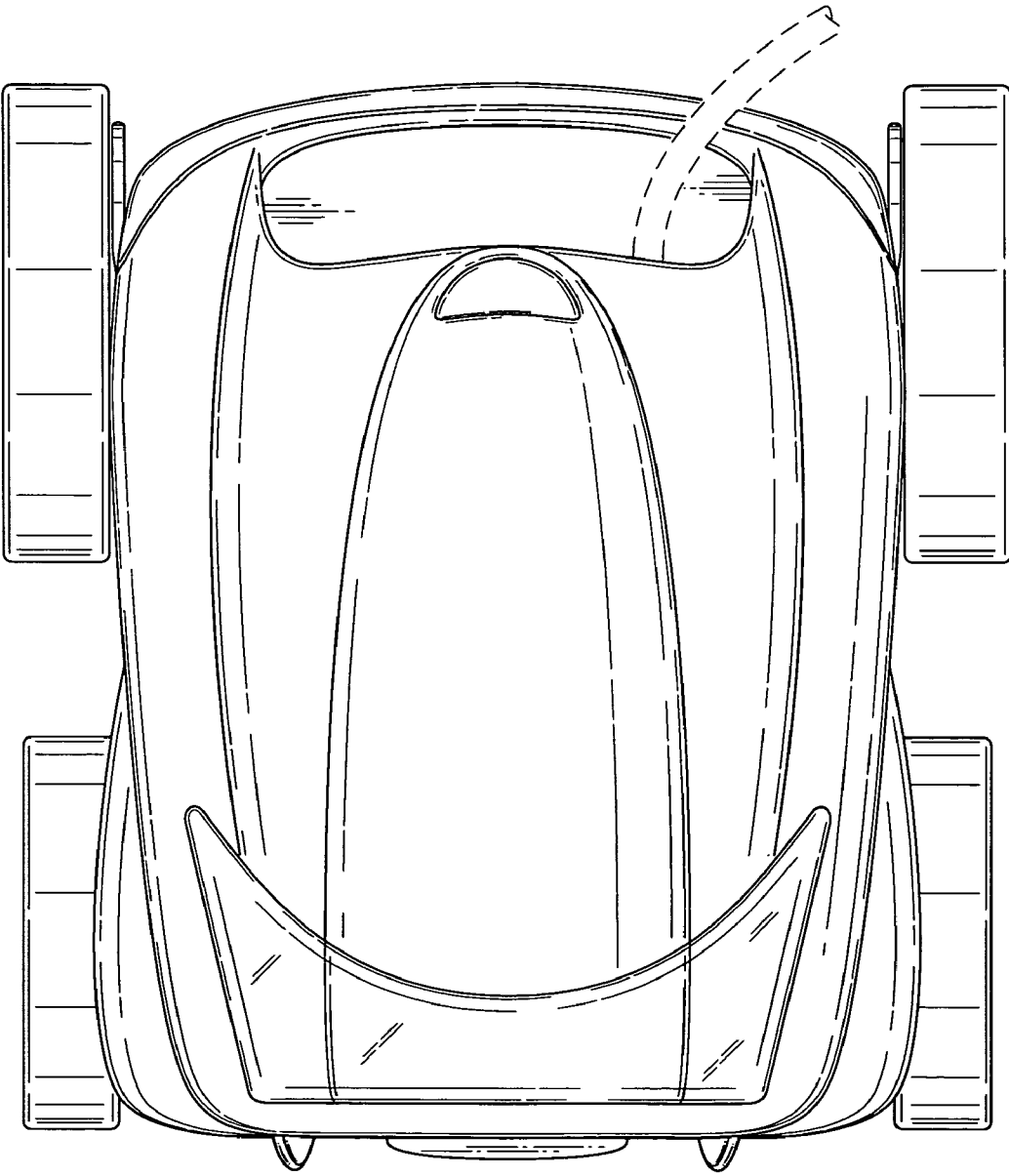

FIG. 3

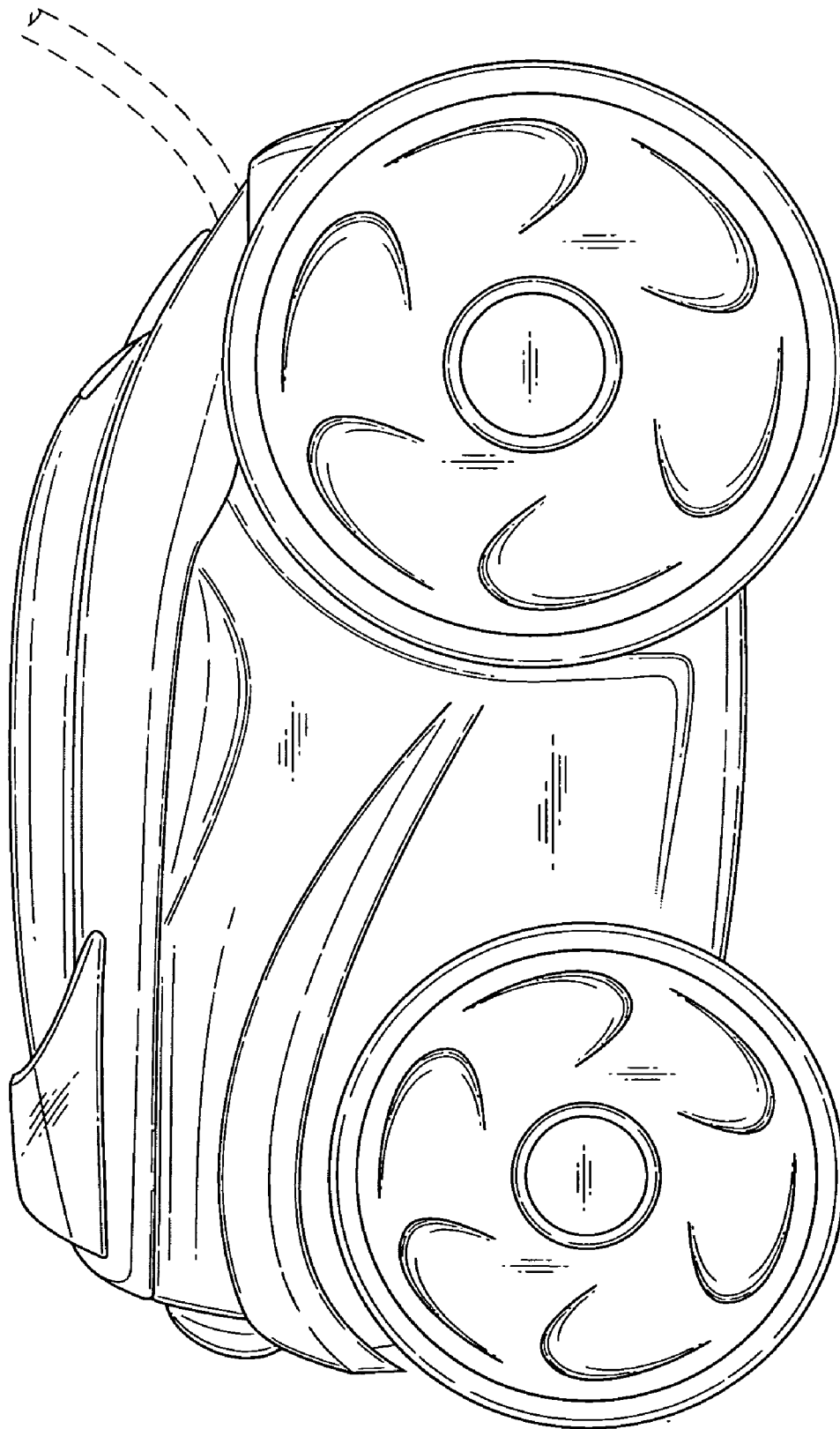

FIG. 4

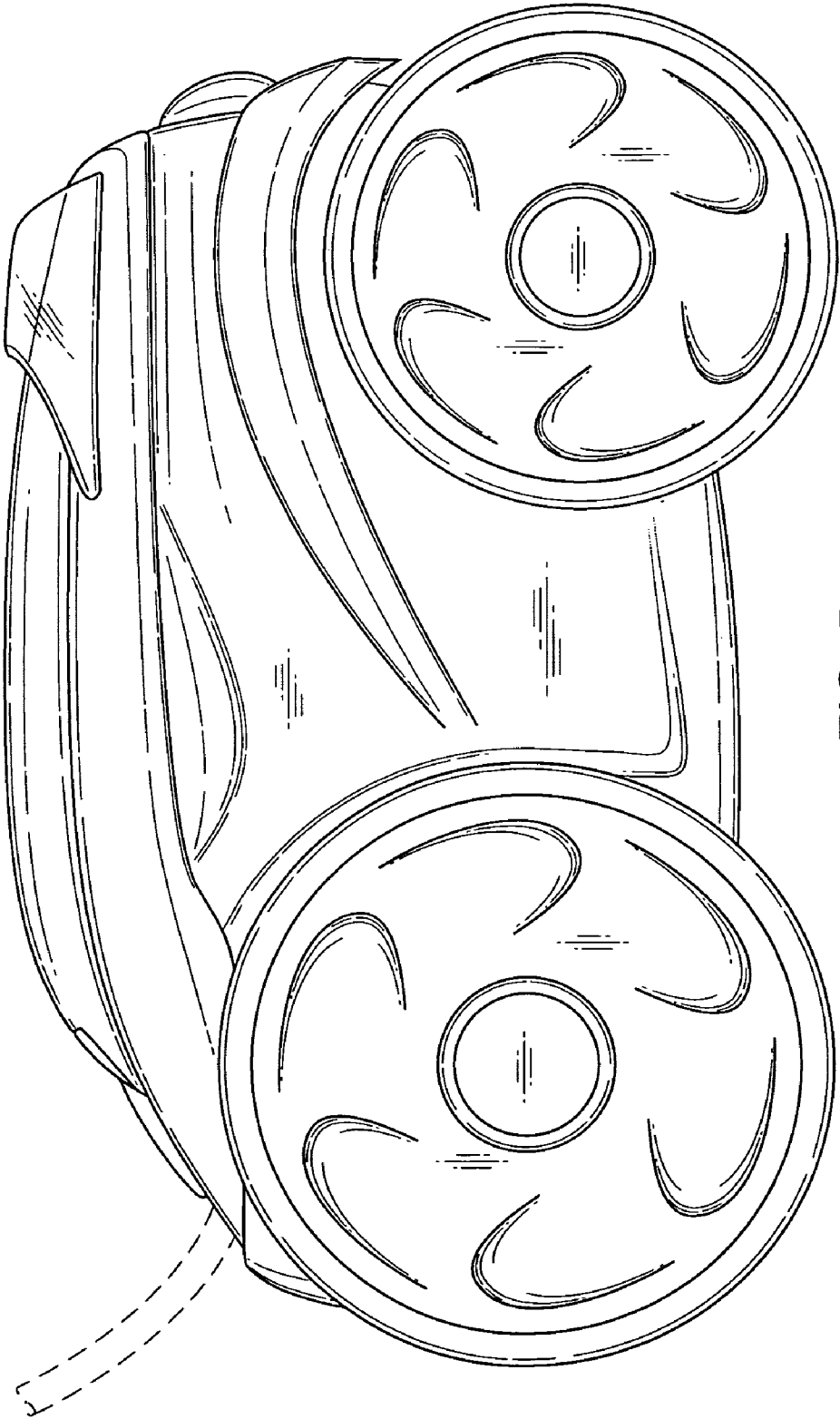

FIG. 5

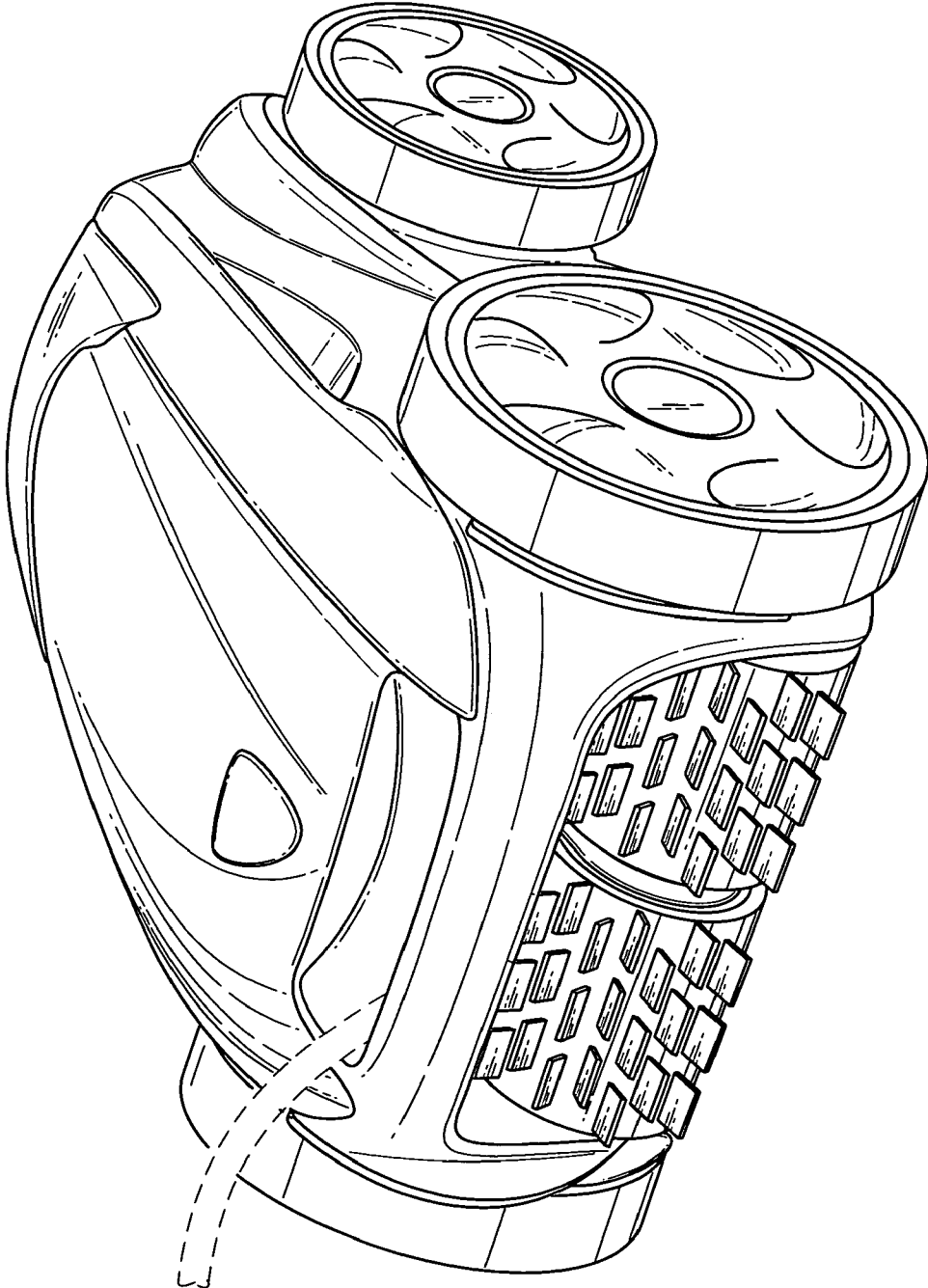

FIG. 6



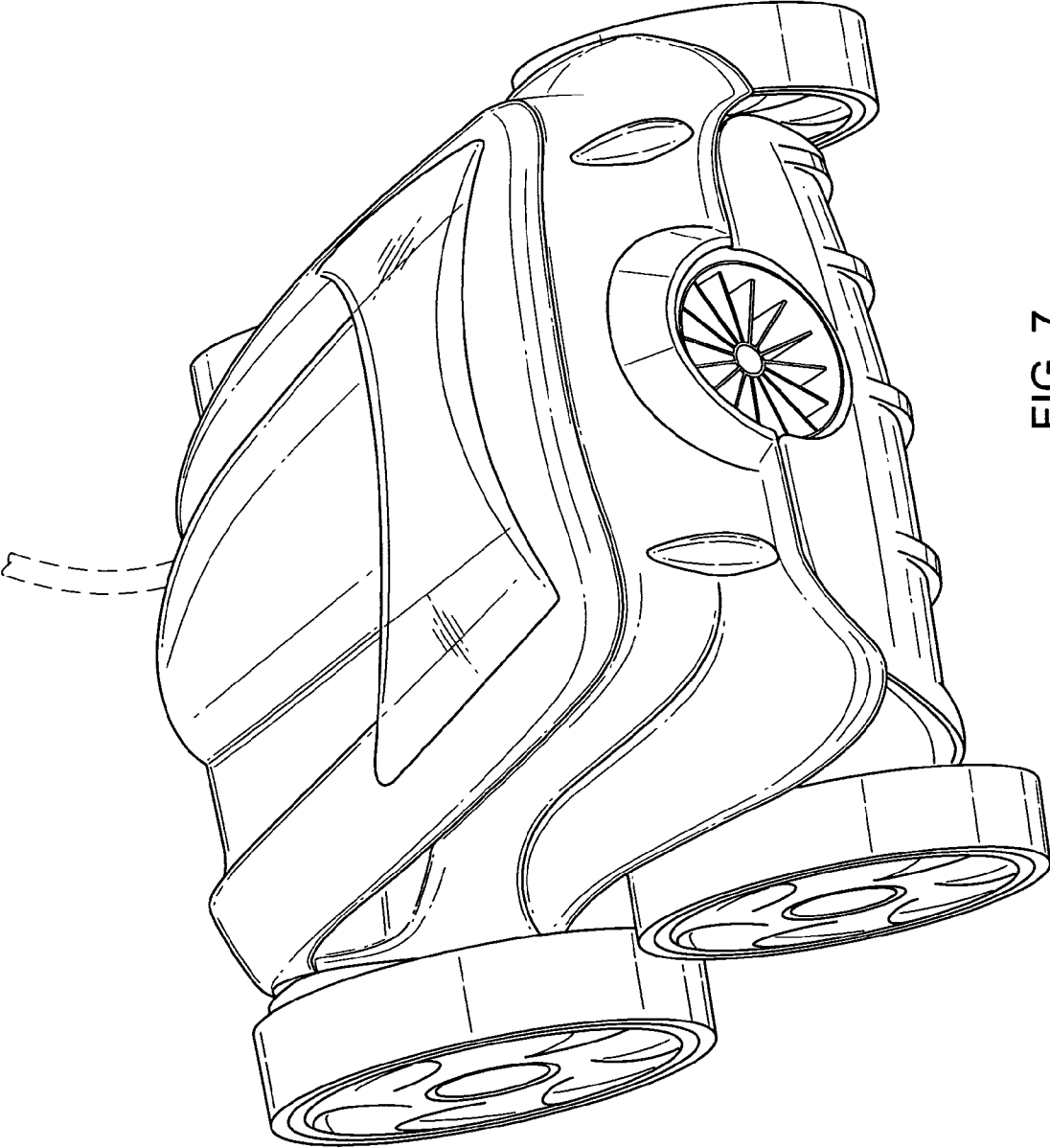

FIG. 7