



US00D790777S

(12) **United States Design Patent**  
**Nifong et al.**

(10) **Patent No.:** **US D790,777 S**  
(45) **Date of Patent:** **\*\* Jun. 27, 2017**

- (54) **NECTAR BIRD FEEDER**
- (71) Applicant: **Classic Brands, LLC**, Denver, CO (US)
- (72) Inventors: **Lindsey Nifong**, Denver, CO (US);  
**Bryan Krueger**, Denver, CO (US)
- (73) Assignee: **Classic Brands, LLC**, Denver, CO (US)
- (\*\*) Term: **15 Years**
- (21) Appl. No.: **29/561,281**
- (22) Filed: **Apr. 14, 2016**
- (51) **LOC (10) Cl.** ..... **30-03**
- (52) **U.S. Cl.**  
USPC ..... **D30/124; D30/128; D30/127**
- (58) **Field of Classification Search**  
USPC ..... D30/121, 124, 127, 128, 133, 114, 115,  
D30/116, 117, 118, 119, 125, 126;  
119/51.03, 57.8, 51.01, 52.2, 710, 711,  
119/52.3, 464, 707, 709, 57.9, 124, 51.04;  
43/2, 131; 47/86, 65, 65.5, 67, 39, 41.12,  
47/79; 426/1, 439, 556; D11/121, 120,  
D11/79, 117; 428/10, 18, 27; D7/352,  
D7/356; 156/256, 263; 66/170; 99/372,  
99/377, 403; 425/318, 395, 404;  
248/175, 27.8; 211/85.31, 88.03, 23;  
362/122, 227, 249.15, 249.16, 249.18,  
362/806  
CPC .... A01K 39/02; A01K 39/0206; A01K 39/04;  
A01K 39/012; A01K 39/026  
See application file for complete search history.

- 117,807 A 8/1871 Orndorff
- D7,964 S 12/1874 Morse
- D8,908 S 1/1876 Wiley
- D17,296 S 5/1887 Putnam et al.
- D20,059 S 7/1890 Irwin
- D22,607 S 7/1893 Johnes
- 502,559 A 8/1893 Gilman
- D24,947 S 12/1895 Feeny et al.
- D28,734 S 5/1898 Muller
- 632,167 A 8/1899 Biesmeyer
- D34,318 S 4/1901 Juhring
- 721,435 A 2/1903 Fielding
- 727,597 A 5/1903 Day
- D36,459 S 7/1903 Brosl
- 813,954 A 2/1906 Davis
- D39,701 S 12/1908 Watkins

(Continued)

**OTHER PUBLICATIONS**

Duncraft, Inc., JB's Hummingbird Feeder, (date unknown) located at <http://www.duncraft.com/JBS-Hummingbird-Feeder>, 3 pages, offered for sale no later than Mar. 27, 2012.

(Continued)

*Primary Examiner* — Susan Moon Lee  
(74) *Attorney, Agent, or Firm* — Polsinelli PC

(57) **CLAIM**

The ornamental design for a nectar bird feeder, as shown and described.

**DESCRIPTION**

FIG. 1 is an isometric view of a nectar bird feeder showing our new design.  
FIG. 2 is a front view thereof.  
FIG. 3 is a back view thereof.  
FIG. 4 is a first side view thereof.  
FIG. 5 is a second side view thereof.  
FIG. 6 is a top view thereof; and,  
FIG. 7 is a bottom view thereof.

**1 Claim, 6 Drawing Sheets**

- (56) **References Cited**  
U.S. PATENT DOCUMENTS  
15,982 A 10/1856 Moulton  
D3,585 S 7/1869 Brown  
D4,451 S 11/1870 Pitts

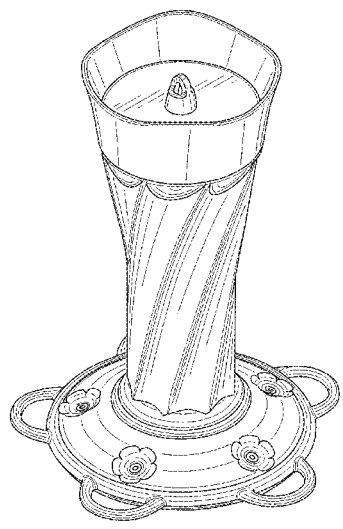

(56)

References Cited

U.S. PATENT DOCUMENTS

954,968 A	4/1910	Jacoy	D149,729 S	5/1948	Aronek	
1,010,543 A	12/1911	Walter et al.	D150,490 S	8/1948	Brown	
1,023,240 A	4/1912	Bowler	D153,759 S	5/1949	Blatt	
D43,781 S	4/1913	Sanford	2,475,207 A	7/1949	Smith	
1,091,392 A	3/1914	Schlichtinger	D158,279 S	4/1950	Hefter-Louiche	
1,107,206 A	8/1914	Schwartzburg	2,570,733 A	10/1951	Thomas	
1,136,092 A	4/1915	Blumere	D166,628 S	1/1952	Blazier	
1,148,873 A	8/1915	Stocking	D166,418 S	4/1952	Sandkuhle	
1,181,045 A	4/1916	Tessier	2,641,086 A	6/1953	Stephen	
1,251,935 A	1/1918	Stevens	2,652,027 A	9/1953	Coyner	
1,265,481 A	5/1918	Mosby	D173,658 S	12/1954	Jones	
1,377,111 A	5/1921	Blair	2,696,803 A	12/1954	Deffenbaugh	
1,377,684 A	5/1921	Hollands	D174,139 S	3/1955	Sadler	
1,391,231 A	9/1921	Wilson	D174,909 S	6/1955	Kllegberg	
1,391,353 A	9/1921	Wells	D175,435 S	8/1955	Moffat	
1,408,410 A	2/1922	Sidle	2,725,663 A	12/1955	Mullen	
1,410,128 A	3/1922	Sands	D178,917 S	* 10/1956	England et al.	D9/539
1,423,547 A	7/1922	Strohbach	D179,507 S	1/1957	Barbiers	
1,426,508 A	8/1922	Rollins	2,778,398 A	1/1957	Edwards	
1,428,475 A	9/1922	Cortland	2,801,611 A	8/1957	Decker	
1,434,831 A	11/1922	Long	2,802,304 A	8/1957	Hille	
D62,888 S	8/1923	Davis, Jr. et al.	D185,577 S	6/1959	Mas	
D62,916 S	8/1923	Peck	2,891,508 A	6/1959	Bower	
1,472,667 A	10/1923	Nelson	D186,085 S	9/1959	Dallas	
D64,637 S	5/1924	Mas	2,971,671 A	2/1961	Shakman	
D65,772 S	10/1924	Caltis	D190,668 S	6/1961	Bliss	
1,517,164 A	11/1924	Lear	D192,435 S	3/1962	Goodman	
1,521,782 A	1/1925	Meier	3,050,619 A	8/1962	Abramson	
1,538,480 A	5/1925	Gallagher	3,051,303 A	8/1962	Daanen et al.	
1,547,762 A	7/1925	Kohlman, Jr.	D194,846 S	3/1963	Perry	
1,555,407 A	9/1925	Ferris	3,089,605 A	* 5/1963	Buonauro	A47G 19/2255 215/377
1,557,068 A	10/1925	Lee	3,090,354 A	5/1963	Merritt et al.	
1,566,571 A	12/1925	Appleton	D196,777 S	11/1963	Haynes	
D69,462 S	2/1926	Sears	3,125,069 A	3/1964	Fowler	
D71,107 S	9/1926	Gorowitz	D197,905 S	4/1964	Friedman et al.	
1,622,975 A	3/1927	Rozic	3,136,296 A	6/1964	Luin	
1,623,439 A	4/1927	Rawlings	D200,472 S	3/1965	Chang	
1,634,569 A	7/1927	Bray	3,244,150 A	4/1966	Benton	
1,634,648 A	7/1927	Cardinet	D205,772 S	9/1966	Blair	
1,644,063 A	10/1927	Kircher	3,272,467 A	9/1966	Kassube	
D76,001 S	8/1928	Broch	3,307,602 A	3/1967	Boster	
1,682,575 A	8/1928	Leon et al.	3,329,321 A	7/1967	Moore	
D76,544 S	10/1928	Kleis	3,372,676 A	3/1968	Williams	
1,698,915 A	1/1929	Kircher	D212,276 S	9/1968	Lodding et al.	
1,707,528 A	4/1929	La Bombard	3,402,871 A	9/1968	Palmer	
D81,439 S	6/1930	Frank	D214,172 S	5/1969	Troutman	
D81,602 S	7/1930	Teague	D216,361 S	* 12/1969	Pappas, Jr.	D9/538
D81,960 S	9/1930	Dickson	3,491,724 A	1/1970	Sunner	
D84,104 S	5/1931	Rithner	D217,470 S	5/1970	Morrow	
1,858,087 A	5/1932	Howard	3,526,335 A	* 9/1970	Swett	A47G 19/2255 215/10
1,864,200 A	6/1932	Kaufmann	3,634,678 A	1/1972	Glass et al.	
1,894,406 A	1/1933	Lenhart	3,661,122 A	5/1972	Willauer, Jr.	
1,905,856 A	4/1933	Haase et al.	D230,295 S	2/1974	Rosenwach	
D90,120 S	6/1933	McNash	D230,948 S	3/1974	Moon	
1,919,916 A	7/1933	Taylor	3,798,826 A	3/1974	Ferguson	
D95,019 S	4/1935	Cooperstein	D234,180 S	1/1975	Dart et al.	
2,000,609 A	5/1935	Pitman	D234,615 S	3/1975	Kilham	
D100,112 S	6/1936	McIntosh	D235,908 S	7/1975	Rosenwach	
D101,483 S	10/1936	Mott	D236,139 S	7/1975	Kilham	
D102,532 S	12/1936	Vuilleminot	3,901,192 A	8/1975	Adams	
D105,812 S	8/1937	Siekert	3,913,527 A	10/1975	Kilham	
D111,229 S	9/1938	Spence	3,928,936 A	12/1975	Wollen	
D112,632 S	12/1938	Berkowitz	D239,182 S	3/1976	Kilham	
D115,321 S	6/1939	Pueschel	D241,149 S	8/1976	Miller et al.	
2,172,789 A	9/1939	Desper	3,979,854 A	9/1976	Perkins	
2,193,492 A	3/1940	Richardson	D241,860 S	10/1976	Calamia	
D121,675 S	7/1940	Goldin	3,997,999 A	12/1976	Evans	
D126,997 S	5/1941	Bentzen et al.	D244,009 S	4/1977	Kayne	
D130,923 S	12/1941	Philipovich	D244,098 S	4/1977	Kilham	
2,267,883 A	12/1941	Wood	D244,786 S	6/1977	Dryden	
D132,522 S	5/1942	Fuerst et al.	4,030,451 A	6/1977	Miller	
2,298,398 A	10/1942	Marshaus	4,037,361 A	7/1977	Murphy et al.	
2,350,922 A	6/1944	Planeta	D246,294 S	11/1977	Hetherington	
D140,392 S	2/1945	Haynes	4,082,872 A	4/1978	Hughes	
2,432,632 A	12/1947	Selbel	4,085,706 A	4/1978	Evans	
			D248,006 S	5/1978	Christian	
			4,096,947 A	6/1978	Morse	

(56)

References Cited

U.S. PATENT DOCUMENTS

4,102,308 A	7/1978	Kilham	D309,639 S	7/1990	Knudsen	
4,144,842 A	3/1979	Schlisling	D309,640 S	7/1990	Knudsen	
D252,288 S	7/1979	Kilham	4,938,168 A	7/1990	Meidell	
D253,706 S	12/1979	Bardeau	D309,858 S	8/1990	Meyersburg	
4,206,529 A	6/1980	Neumann	D314,253 S	1/1991	Goetz	
D258,338 S	2/1981	Gersin	4,980,990 A *	1/1991	Hiday .....	A01K 39/0113
D258,566 S	3/1981	Potter				43/107
D258,570 S	3/1981	Pettengill	4,995,526 A	2/1991	Garrison	
D259,763 S	7/1981	Dickinson	4,996,947 A	3/1991	Petrides	
D260,184 S	8/1981	Whatley	5,016,791 A	5/1991	Burow	
D260,608 S	9/1981	McKee, Jr.	5,031,575 A	7/1991	Phillips	
D260,830 S	9/1981	Trouba	5,033,411 A	7/1991	Brucker	
D260,843 S	9/1981	Laird et al.	D318,887 S	8/1991	Laib	
D264,434 S	5/1982	Pettengill	D319,268 S	8/1991	Laib	
4,327,669 A	5/1982	Blasbalg	D319,389 S	8/1991	Halm	
D264,812 S	6/1982	O'Toole	5,040,698 A	8/1991	Ramsey et al.	
D264,813 S	6/1982	Potter	D321,382 S	11/1991	Laib	
D265,939 S	8/1982	Kilham	5,062,390 A	11/1991	Bescherer et al.	
D266,611 S	10/1982	Metts et al.	D322,044 S	12/1991	Marsar et al.	
4,361,116 A	11/1982	Kilham	5,083,881 A	1/1992	Yoshinaga	
D267,355 S	12/1982	Blasbalg	5,088,615 A	2/1992	Neuman	
4,369,216 A	1/1983	Willinger	D324,436 S	3/1992	Embree	
D268,056 S	2/1983	Campbell-Kelly et al.	5,101,996 A	4/1992	Mosley	
4,395,015 A	7/1983	Reardon	D326,003 S	5/1992	Embree	
D271,434 S	11/1983	Love	D326,411 S	5/1992	Weffler	
D272,507 S	2/1984	Conti	5,140,945 A	8/1992	Barnhart et al.	
D272,508 S	2/1984	Conti	D329,892 S	9/1992	Brister	
D273,429 S	4/1984	Kilham	D330,676 S	11/1992	Halasz et al.	
4,441,458 A	4/1984	Mercil	D331,647 S	12/1992	Embree	
4,444,324 A	4/1984	Grenell	D331,864 S	12/1992	Sciubba	
D276,891 S	12/1984	Fortuna	D332,750 S	1/1993	Moloney et al.	
D277,514 S	2/1985	Bescherer	D333,065 S	2/1993	Murphy	
D277,703 S	2/1985	Kilham	D333,538 S	2/1993	Kinglsye	
D277,988 S	3/1985	Kilham	5,183,005 A	2/1993	Tyler	
4,506,657 A	3/1985	Trolle	5,195,463 A	3/1993	Lorenzana et al.	
D278,751 S	5/1985	Seager	D334,635 S	4/1993	Wenstrand	
4,516,533 A	5/1985	Mallinson	D335,006 S	4/1993	Blasbalg	
D279,456 S	7/1985	Fortuna	5,207,180 A	5/1993	Graham	
D280,559 S	9/1985	Bentall	5,215,040 A	6/1993	Lemley	
D280,700 S	9/1985	Martin et al.	5,215,210 A	6/1993	Ostrum et al.	
D281,768 S	12/1985	Hansen, Jr.	D337,271 S	7/1993	Pezzoli et al.	
D282,019 S	12/1985	Kilham	D337,614 S	7/1993	Turner	
D284,033 S	5/1986	Brodsky	D338,317 S	8/1993	Woodward	
4,588,618 A	5/1986	Wolfe	D338,614 S	8/1993	Pierce	
D284,167 S	6/1986	Goettner	D338,615 S	8/1993	Magidson et al.	
D285,840 S	9/1986	Poon	5,247,904 A	9/1993	Anderson	
D287,647 S	1/1987	Ringle	5,253,609 A	10/1993	Partelow et al.	
D287,652 S	1/1987	Mack	5,261,558 A	11/1993	Claydon	
D288,353 S	2/1987	Smith	D343,030 S	1/1994	Harwick, Jr.	
4,651,791 A	3/1987	Evenson	D344,390 S	2/1994	May et al.	
D289,143 S	4/1987	Guillaume	D345,444 S	3/1994	Kestekides-Kesdekoglu	
4,664,066 A	5/1987	Steuernagel et al.	5,289,796 A	3/1994	Armstrong	
D290,773 S	7/1987	Liethen	5,291,855 A	3/1994	Laverty	
D291,656 S	9/1987	Bussell	D346,745 S	5/1994	Heynen et al.	
4,691,665 A *	9/1987	Hefner .....	D347,172 S	5/1994	Heynen et al.	
		A01K 39/012	D347,714 S *	6/1994	Maple .....	D30/128
		119/57.8	D350,047 S	8/1994	Kiyokane	
D292,372 S	10/1987	Sykes	D353,250 S	12/1994	Skalka	
4,702,198 A	10/1987	Holyoak	D356,265 S	3/1995	Moloney et al.	
4,708,892 A	11/1987	Young et al.	5,396,878 A	3/1995	Quist	
4,712,512 A	12/1987	Schrieb et al.	D357,778 S	4/1995	Dalgarno	
D293,823 S	1/1988	Fieschi et al.	D358,547 S	5/1995	Darr	
D294,050 S	2/1988	Zinter-Chahin	D359,708 S	6/1995	Boscatto	
4,732,112 A *	3/1988	Fenner .....	D360,710 S	7/1995	Colwell	
		A01K 39/012	D360,829 S	8/1995	Leeds	
		119/52.2	D362,089 S	9/1995	Moore et al.	
D297,297 S	8/1988	Lacey	5,450,816 A	9/1995	Santa Cruz	
D299,015 S	12/1988	Seymour	D365,411 S	12/1995	Yan	
D299,105 S	12/1988	Sun	D366,413 S	1/1996	Tober	
4,789,572 A	12/1988	Weaver	5,479,879 A	1/1996	Biek	
D299,770 S	2/1989	Coffer	D367,614 S	3/1996	Pagarani	
4,803,954 A	2/1989	Welch et al.	D368,337 S	3/1996	Dickinson	
D304,536 S	11/1989	Blaser	D368,347 S	3/1996	Kruger	
D304,811 S	11/1989	Thurman	D368,989 S	4/1996	Prehart	
4,896,628 A	1/1990	Kadunce	5,507,249 A	4/1996	Shaw	
4,901,673 A	2/1990	Overstreet	D370,313 S	5/1996	Nottingham et al.	
D309,261 S	7/1990	Weckman	D370,634 S	6/1996	Mero et al.	
			5,522,758 A	6/1996	Liu	
			D371,401 S	7/1996	Nielsen et al.	

(56)

## References Cited

## U.S. PATENT DOCUMENTS

D371,838	S	7/1996	Davis et al.		D445,533	S	7/2001	Arnoldo	
5,564,226	A	10/1996	Paramest		D445,939	S	7/2001	Pan	
D376,035	S	11/1996	Boucheron		6,269,774	B1	8/2001	Stewart	
D376,453	S	12/1996	Park		D447,957	S	9/2001	Lichtman et al.	
D376,731	S	12/1996	Lin		D448,290	S	9/2001	Schultz et al.	
D378,055	S	2/1997	Waldon et al.		D449,204	S	10/2001	Groll	
D378,312	S	3/1997	Davis, Jr.		D450,786	S	11/2001	Jenkins et al.	
5,638,638	A	6/1997	Moskowitz		D451,237	S	11/2001	Dolan	
D382,376	S	8/1997	Bescherer	D30/124	D451,997	S	12/2001	Schwartz	
5,655,477	A	8/1997	Hoffman et al.		D452,748	S	1/2002	Dolan	
D385,067	S	10/1997	Whittles		D454,192	S	3/2002	Frampton	
5,678,600	A	10/1997	Locke et al.		D454,636	S	3/2002	Lantz	
D386,116	S	11/1997	Sanderson		D454,669	S	3/2002	Lieb	D30/125
D386,811	S	11/1997	Milicia		6,360,690	B1	3/2002	Canby	
D386,835	S	11/1997	Passamare		D455,599	S	4/2002	Cheng	
D386,836	S	11/1997	Hunt		D455,961	S	4/2002	Edson et al.	
5,682,835	A	11/1997	Walter	A01K 39/0206 119/57.8	D459,824	S	7/2002	Leen	
D387,156	S	12/1997	Johnson		D460,591	S	7/2002	Skalka	
D388,235	S	12/1997	Wilson et al.		D460,592	S	7/2002	Skalka	
D392,763	S	3/1998	Denison		D461,827	S	8/2002	Koebbe	
5,722,344	A	3/1998	Rank		D461,939	S	8/2002	Skalka	
D394,468	S	5/1998	Leadbetter		6,427,629	B1	8/2002	Lush	
D395,840	S	7/1998	Cato		6,439,158	B1	8/2002	Blohm	
5,782,200	A	7/1998	Knowles et al.		D463,046	S	9/2002	Kumar	
D397,529	S	8/1998	Fuller et al.		D464,184	S	10/2002	Skalka	
5,800,047	A	9/1998	Yang		D464,781	S	10/2002	Skalka	
5,806,460	A	9/1998	Klein		6,463,878	B1	10/2002	Moody	
D399,611	S	10/1998	Ericson	D30/124	D465,892	S	11/2002	Weiss et al.	
D400,106	S	10/1998	Anderson et al.		D466,255	S	11/2002	Kuelbs	
5,816,686	A	10/1998	Wang et al.		D466,656	S	12/2002	Kuelbs et al.	
5,823,135	A	10/1998	Gilchrist et al.		D466,664	S	12/2002	Hsu	
D401,475	S	11/1998	Ritchey		6,499,430	B2	12/2002	Garcia-Lucio et al.	
5,845,605	A	12/1998	Malamphy		D469,360	S	1/2003	Moore et al.	
5,848,493	A	12/1998	Gasper		D470,621	S	2/2003	Cheng	
D406,307	S	3/1999	Kang		D470,630	S	2/2003	Kuelbs	
5,881,671	A	3/1999	Riedl		D471,092	S	3/2003	Thorne et al.	
D408,420	S	4/1999	Buter		D471,093	S	3/2003	Thorne et al.	
D410,096	S	5/1999	Majerowski		D471,096	S	3/2003	Thorne et al.	
5,899,355	A	5/1999	Claydon et al.		D471,327	S	3/2003	Kuelbs	
5,899,555	A	5/1999	Lin		D472,351	S	3/2003	Griffin	D11/148
D410,592	S	6/1999	Niemiec		D473,739	S	4/2003	Lenger	
D412,226	S	7/1999	Bellehumer		6,543,384	B2	4/2003	Cote	
5,918,415	A	7/1999	Locke et al.		6,546,894	B2	4/2003	Chrisco et al.	
D413,406	S	8/1999	Hsu		D476,179	S	6/2003	Lenger	
5,947,054	A	9/1999	Liethen		D476,755	S	7/2003	LoVullo et al.	
D417,326	S	11/1999	Greene		D477,778	S	7/2003	Dretzka	
D417,528	S	12/1999	Rizzo		6,591,781	B2	7/2003	Hardison	
6,012,414	A	1/2000	Klein		D478,475	S	8/2003	Backes et al.	
D420,284	S	2/2000	Sagel		D479,595	S	9/2003	Curtin	
D421,393	S	3/2000	Pavely et al.		D479,596	S	9/2003	Curtin	
D421,643	S	3/2000	Mauk		D479,597	S	9/2003	Curtin	
D423,166	S	4/2000	Hornyak		D480,135	S	9/2003	Frampton	
D423,722	S	4/2000	Lang		D480,802	S	10/2003	Frampton	
D425,259	S	5/2000	Lang		D480,803	S	10/2003	Frampton	
6,067,934	A	5/2000	Harwich	A01K 39/014 119/51.03	D482,562	S	11/2003	Demers	
6,079,361	A	6/2000	Bowell et al.		D482,736	S	11/2003	Manville	
D428,757	S	8/2000	Loffler et al.		D483,529	S	12/2003	Fort, II	
D429,852	S	8/2000	Hogarty		D483,537	S	12/2003	Skalka	
D431,760	S	10/2000	Sullivan		D483,858	S	12/2003	Lin	
D433,633	S	11/2000	La Fata		6,659,041	B1	12/2003	Curts	A01K 39/0206 119/52.2
D433,747	S	11/2000	Frampton		6,662,747	B1	12/2003	Wydra	
6,145,477	A	11/2000	Jansen		D485,068	S	1/2004	Opiniano	
D434,980	S	12/2000	Suziki		D485,208	S	1/2004	Fan	
D435,219	S	12/2000	Williams et al.		D485,345	S	1/2004	Bucher	
D435,688	S	12/2000	Johnson		D485,350	S	1/2004	Frampton	
6,167,840	B1	1/2001	White et al.		D485,351	S	1/2004	Frampton	
D438,360	S	2/2001	Robinson		D485,387	S	1/2004	Harbaugh	
D440,002	S	4/2001	Miranda		D485,928	S	1/2004	Leung et al.	
D440,361	S	4/2001	Colwell		6,672,249	B2	1/2004	Garcia-Lucio et al.	
D440,677	S	4/2001	Long et al.		D487,177	S	2/2004	Skalka	
6,213,054	B1	4/2001	Marshall		D488,195	S	4/2004	Manville	
D443,711	S	6/2001	Lindsay		D488,219	S	4/2004	Frampton	
D445,525	S	7/2001	Pan		D488,901	S	4/2004	Skalka	
					D489,128	S	4/2004	Frampton	
					D489,940	S	5/2004	Gluck	
					D490,192	S	5/2004	Markusen et al.	
					6,733,151	B2	5/2004	Shu	
					D490,745	S	6/2004	Fan	

(56)

## References Cited

## U.S. PATENT DOCUMENTS

D491,019	S	6/2004	Marsden et al.	D543,256	S	5/2007	Chen
D491,657	S	6/2004	Cartwright	D543,665	S	5/2007	Hewitt et al.
D491,696	S	6/2004	Cole	D544,942	S	6/2007	Chen
D492,601	S	7/2004	Ogata et al.	7,234,416	B2	6/2007	Hoff
D493,053	S	7/2004	Snell	7,234,418	B2	6/2007	Fort et al.
D493,358	S	7/2004	Graves et al.	D545,984	S	7/2007	Leung et al.
6,776,511	B1	8/2004	Lindsay	D546,991	S	7/2007	Poon
D495,839	S	9/2004	Muday et al.	D548,321	S	8/2007	Orozco
D495,900	S	9/2004	Mayse	D548,525	S	8/2007	Gibbons et al.
6,792,891	B1	9/2004	Coburn et al.	7,258,075	B1	8/2007	Jones et al.
D497,406	S	10/2004	King	7,261,055	B2	8/2007	Nock
D497,458	S	10/2004	Nauert	D551,986	S	10/2007	Rubin et al.
D501,805	S	2/2005	Opiniano	D553,821	S	10/2007	Skalka
D502,293	S	2/2005	Harger	D554,252	S	10/2007	Bucher et al.
D502,294	S	2/2005	Hung	7,287,486	B2	10/2007	Hunter
D503,019	S	3/2005	Swift et al.	D558,419	S	12/2007	Zychlinski
6,860,229	B1	3/2005	Craft	D559,472	S	1/2008	Abinanti et al.
6,861,108	B1	3/2005	Potoroka, Sr.	D561,021	S	2/2008	DuVal et al.
6,866,004	B1	3/2005	Lush	D561,040	S	2/2008	Sequeira
D504,746	S	5/2005	Lee	D561,967	S	2/2008	Skalka
D504,987	S	5/2005	Morris, Sr.	D563,608	S	3/2008	Kitchen
D505,521	S	5/2005	Schrodt	D563,616	S	3/2008	Lynde et al.
D505,755	S	5/2005	Lundstrom et al.	D565,173	S	3/2008	Bucher et al.
6,890,155	B2	5/2005	Cartwright	D567,098	S	4/2008	Sequeira
D506,826	S	6/2005	Frampton	D568,754	S	5/2008	Sequeira
D509,325	S	* 9/2005	Jung ..... A01K 39/012 D30/127	D569,301	S	5/2008	Fotherby
D509,748	S	9/2005	Carmichael et al.	7,373,901	B2	5/2008	Baynard
D509,749	S	9/2005	Shun	D571,056	S	6/2008	Bloedorn
6,945,192	B2	9/2005	Cote	D572,067	S	7/2008	Opiniano
D510,992	S	10/2005	Bucher	D572,145	S	7/2008	Knapp et al.
D511,074	S	11/2005	Claypool et al.	D572,866	S	7/2008	Bloedorn
D512,315	S	12/2005	Holm	D573,769	S	7/2008	Skalka
D513,188	S	12/2005	Bertrand	7,396,212	B1	7/2008	Parker et al.
6,986,322	B2	1/2006	Lumpkin et al.	D575,118	S	8/2008	Bignon
D514,749	S	2/2006	Fort et al.	D575,591	S	8/2008	Bonetti
D515,455	S	2/2006	Opiniano	D575,864	S	8/2008	Parker et al.
D515,916	S	2/2006	Bleuer	7,409,922	B1	8/2008	Baynard et al.
D516,462	S	3/2006	Opiniano	D576,497	S	9/2008	Ozer
D516,712	S	3/2006	Pickett	7,418,923	B1	9/2008	Banyas et al.
D516,946	S	3/2006	Opiniano	D581,193	S	11/2008	Ghiorghie
D518,380	S	4/2006	Moran	7,448,346	B1	11/2008	Stone et al.
D518,382	S	4/2006	McGuinness	7,448,347	B2	11/2008	Richmond
7,032,538	B1	4/2006	Lush	D583,187	S	12/2008	Rapaz
D521,194	S	5/2006	Weiland	D584,387	S	1/2009	Lee et al.
7,040,251	B2	5/2006	Fort, II	D584,954	S	1/2009	Pagliacci
D522,816	S	6/2006	Schuler	D585,625	S	1/2009	Gray
D522,873	S	6/2006	Forget	D586,228	S	2/2009	McWillis
D523,141	S	6/2006	Massey	7,484,475	B2	2/2009	Milliner
D523,774	S	6/2006	Opiniano	D587,941	S	3/2009	Singh
D523,955	S	6/2006	Badarello	D588,756	S	3/2009	Colvin et al.
D524,164	S	7/2006	Goda	7,503,282	B1	3/2009	Lush
D524,490	S	7/2006	Obenshain	7,506,611	B1	3/2009	Lush
D525,560	S	7/2006	Opiniano	7,516,716	B2	4/2009	Puckett et al.
D525,903	S	8/2006	Weiser et al.	D591,589	S	5/2009	Myers et al.
7,093,562	B2	* 8/2006	Smothers ..... A01K 39/0206 119/72	D592,046	S	5/2009	Myers et al.
7,096,821	B2	8/2006	Ruff	D593,649	S	6/2009	Marvell
D528,464	S	9/2006	Opiniano	D595,525	S	7/2009	Dimond
D528,940	S	9/2006	Espejo	D596,033	S	7/2009	Zach et al.
D529,220	S	9/2006	Izardel	D597,197	S	7/2009	Parker et al.
D530,444	S	10/2006	Girard	D598,238	S	8/2009	Durdon et al.
D530,457	S	* 10/2006	Jung ..... D30/127	D599,159	S	9/2009	Stein
D532,132	S	11/2006	Holsinger et al.	D599,899	S	9/2009	Thompson
D536,838	S	2/2007	Colvin et al.	D600,861	S	9/2009	Sin
D538,485	S	3/2007	Degironne	D601,309	S	9/2009	Babal
D538,583	S	3/2007	Schuler	7,600,487	B2	10/2009	Stone et al.
7,185,605	B1	3/2007	Lush	D604,436	S	11/2009	Poon
D539,991	S	4/2007	Petrie et al.	D606,369	S	12/2009	Ruzycky
D540,349	S	4/2007	Waki	D606,447	S	12/2009	West et al.
D541,466	S	4/2007	Bucher et al.	D606,708	S	* 12/2009	McMullen ..... D30/127
D542,479	S	5/2007	O'Dell	D606,709	S	* 12/2009	McMullen ..... D30/127
D542,591	S	5/2007	Carlson	D606,878	S	12/2009	Lindfors
D542,659	S	5/2007	Meether et al.	D607,612	S	1/2010	Yang
D542,993	S	5/2007	Skalka	D609,329	S	2/2010	Parker et al.
				D609,864	S	2/2010	Tsai
				7,654,225	B2	2/2010	Madsen et al.
				D612,549	S	3/2010	Garcia-Lucio et al.
				7,685,969	B2	3/2010	Stone et al.
				D614,825	S	4/2010	Biegel
				D615,310	S	5/2010	Cybulski

(56)

References Cited

U.S. PATENT DOCUMENTS

7,721,676 B2	5/2010	Bloedorn		D679,453 S *	4/2013	Krueger	D30/127
D618,733 S	6/2010	Kessler		D682,481 S *	5/2013	Krueger	D30/124
7,743,732 B2	6/2010	Webber		D682,482 S	5/2013	Nelson	
D620,172 S	7/2010	Orozco		D683,510 S	5/2013	Schick	
D623,005 S	9/2010	Cheng		D683,909 S	6/2013	Muhr et al.	
D623,806 S	9/2010	Modi et al.		D685,603 S	7/2013	Mishan	
D624,352 S	9/2010	Lion et al.		D689,730 S	9/2013	Goto et al.	
7,789,040 B2	9/2010	Liethen		D692,191 S	10/2013	Stephens et al.	
D627,457 S	11/2010	Klausning et al.		D693,182 S	11/2013	Katterheinrich	
7,827,936 B1	11/2010	Puckett et al.		8,584,894 B1	11/2013	Mulvaney	
D629,137 S	12/2010	Chen		D698,098 S	1/2014	Muhr et al.	
D630,969 S	1/2011	Mattis		D698,100 S	1/2014	Muhr et al.	
D631,149 S	1/2011	Fis-Menache		D704,385 S	5/2014	Hoofman	
7,861,671 B2	1/2011	Carter et al.		D704,902 S	5/2014	Wu	
7,874,264 B2	1/2011	McMullen		D707,401 S	6/2014	Chen	
7,886,695 B2	2/2011	Held et al.		D709,317 S	7/2014	Cheng	
D633,659 S	3/2011	Lai		D709,330 S	7/2014	Holmes	
D636,238 S	4/2011	Elmelund		8,763,556 B1 *	7/2014	Vaughn, Jr. ....	A01K 39/0206 119/52.2
D636,539 S	4/2011	Montoya		D710,686 S	8/2014	Gowens	
D636,945 S	4/2011	Anderson		D711,679 S	8/2014	Day et al.	
D636,946 S	4/2011	Able		D713,101 S	9/2014	Bruno	
D637,448 S	5/2011	Cheng		D715,091 S	10/2014	Thun et al.	
7,946,248 B2	5/2011	Colwell et al.		D715,092 S	10/2014	Thun et al.	
7,946,249 B2	5/2011	Colvin et al.		D715,588 S	10/2014	Thun et al.	
7,946,734 B2	5/2011	Laporte		8,863,692 B2 *	10/2014	Colvin	A01K 39/024 119/74
7,958,845 B2	6/2011	Gardner		D717,200 S	11/2014	Thuma et al.	
D641,261 S	7/2011	Diss et al.		D717,201 S	11/2014	Thuma et al.	
D641,516 S	7/2011	Chen		D720,506 S	12/2014	Bruno et al.	
D643,442 S	8/2011	Sato et al.		8,899,179 B1	12/2014	Carter et al.	
D643,855 S	8/2011	Taniguchi et al.		D721,208 S *	1/2015	Chen	D30/124
D644,052 S	8/2011	Kraemer		D723,757 S	3/2015	Lentine	
7,997,434 B2 *	8/2011	Benetti	A47G 19/2255 215/370	D728,035 S	4/2015	Kneller	
8,006,946 B2	8/2011	Bonnema		D728,864 S *	5/2015	Schroeder	D30/124
D644,469 S	9/2011	Kraemer		D729,989 S	5/2015	Krueger	
8,011,323 B2	9/2011	Vaughn et al.		RE45,715 E *	10/2015	Krueger	D30/127
D648,492 S	11/2011	Able		D743,137 S	11/2015	Vasilakes	
D649,299 S	11/2011	Lush		D743,636 S	11/2015	Krueger	
D649,302 S	11/2011	Hickok		D744,172 S	11/2015	Donegan et al.	
D649,471 S	11/2011	Guglielmo et al.		RE45,837 E *	1/2016	Krueger	D30/124
8,051,803 B2	11/2011	Gauker et al.		D748,880 S	2/2016	Lentine	
D650,514 S	12/2011	Lin et al.		D756,570 S	5/2016	Donegan et al.	
D650,690 S	12/2011	Guglielmo et al.		2002/0121246 A1	9/2002	Harman	
D652,059 S	1/2012	Sato et al.		2003/0033985 A1	2/2003	Hardison	
D652,343 S	1/2012	Hunter et al.		2003/0226514 A1	12/2003	Cote	
D652,742 S	1/2012	Diss		2004/0010971 A1	1/2004	Redfield et al.	
D652,972 S	1/2012	Lee		2004/0074397 A1	4/2004	Calhoun	
D653,011 S	1/2012	Myers		2004/0118354 A1	6/2004	Cox et al.	
D653,124 S	1/2012	Diss		2004/0134437 A1	7/2004	Fort	
D653,562 S	2/2012	Ziegler et al.		2004/0261726 A1	12/2004	Lumpkin	
D653,563 S	2/2012	Ziegler et al.		2005/0120967 A1	6/2005	Ruff	
D656,279 S *	3/2012	Tu	D30/127	2005/0127074 A1	6/2005	Kusuma et al.	
D656,690 S *	3/2012	Tu	D30/127	2006/0005774 A1	1/2006	Newman Bornhofen	
D657,399 S	4/2012	Nemoto		2006/0065202 A1	3/2006	Fort et al.	
D658,684 S	5/2012	Roman		2006/0090391 A1	5/2006	Huang	
D658,930 S	5/2012	Munari		2006/0090707 A1 *	5/2006	Donegan	A01K 39/012 119/72
D661,434 S	6/2012	Fields et al.		2006/0096545 A1	5/2006	Cone et al.	
D662,652 S	6/2012	Browder		2006/0117962 A1	6/2006	Hoekstra et al.	
D664,437 S	7/2012	Barel		2006/0124067 A1	6/2006	Taylor	
8,230,809 B2	7/2012	Cote		2006/0225658 A1	10/2006	Baynard	
D665,627 S	8/2012	De Winter		2006/0236591 A1	10/2006	Cwiklinski et al.	
8,272,607 B2	9/2012	Bonnema		2007/0006813 A1	1/2007	Smothers	
D670,042 S	10/2012	Anderson		2007/0108197 A1	5/2007	Richardson et al.	
8,276,541 B2	10/2012	LoRocco et al.		2007/0221133 A1	9/2007	Richmond	
D670,836 S	11/2012	Hisey et al.		2008/0006212 A1	1/2008	Ebert	
D671,276 S	11/2012	Krueger		2008/0035068 A1	2/2008	Gou	
D671,692 S	11/2012	Carter		2008/0134979 A1	6/2008	Crocker	
8,316,800 B2	11/2012	Puckett et al.		2008/0244959 A1	10/2008	Schinazi et al.	
D673,722 S	1/2013	Cartwright		2008/0257273 A1	10/2008	Carter et al.	
D673,727 S	1/2013	Cartwright		2008/0302304 A1	12/2008	Mayfield	
8,360,005 B1	1/2013	Allen		2009/0056633 A1	3/2009	McDaniel et al.	
D676,614 S	2/2013	Fields et al.		2009/0056636 A1	3/2009	Deese et al.	
D677,574 S	3/2013	Barnard et al.		2009/0078211 A1	3/2009	Charlton	
D677,575 S	3/2013	Barnard et al.		2009/0145875 A1	6/2009	Gardner	
D678,628 S *	3/2013	Krueger	D30/127	2009/0229528 A1	9/2009	McMurtry	
				2009/0304876 A1	12/2009	Weiss	
				2009/0308321 A1	12/2009	Szczygiel- Durante	

(56)

**References Cited**

U.S. PATENT DOCUMENTS

2009/0320765	A1	12/2009	Gauker et al.	
2010/0024738	A1	2/2010	Chen et al.	
2010/0089330	A1*	4/2010	McMullen .....	A01K 39/0206 119/52.3
2010/0170447	A1	7/2010	Pridgen, Jr.	
2010/0180828	A1	7/2010	DeMichael	
2010/0218754	A1	9/2010	Kuntz	
2010/0224132	A1	9/2010	Gauker	
2010/0242848	A1	9/2010	Vaughn, Jr.	
2011/0094449	A1*	4/2011	George .....	A01K 39/012 119/61.1
2011/0239949	A1*	10/2011	Abbott .....	A01K 39/02 119/72
2011/0297095	A1	12/2011	Cruz	
2012/0060762	A1*	3/2012	Cowger .....	A01K 39/0206 119/74
2012/0216750	A1	8/2012	Cruz	
2012/0311919	A1	12/2012	Hardigree	
2013/0284102	A1	10/2013	McCune	
2013/0291802	A1	11/2013	Carpentieri	
2014/0109835	A1*	4/2014	Colvin .....	A01K 39/0206 119/74
2014/0137804	A1*	5/2014	Chen .....	A01K 39/0206 119/72
2014/0352621	A1	12/2014	Fairbanks	
2015/0122184	A1	5/2015	Donegan et al.	
2015/0122186	A1	5/2015	Donegan et al.	

OTHER PUBLICATIONS

Duncraft, Inc., Jewel Hummingbird Feeder, (date unknown) located at <http://www.duncraft.com/Jewel-Cut-Hummingbird-Feeder>, 2 pages, offered for sale no later than Mar. 27, 2012.

Duncraft, Inc., Lantern Hummingbird Feeder, (date unknown) located at [http://www.duncraft.com/index/page/product/product\\_id/1326/product\\_name/Lantern+Hummingbird+Feeder](http://www.duncraft.com/index/page/product/product_id/1326/product_name/Lantern+Hummingbird+Feeder), 2 pages, offered for sale no later than Mar. 27, 2012.

Duncraft, Inc., Deluxe Hummer Feeder, (date unknown) located at [http://www.duncraft.com/index/page/product/product\\_id/1020/product\\_name/Deluxe+Hummer+Feeder](http://www.duncraft.com/index/page/product/product_id/1020/product_name/Deluxe+Hummer+Feeder), 2 pages, offered for sale no later than Mar. 27, 2012.

Duricraft, Inc., Four Flower Frolic Feeder Set, (date unknown) located at <http://www.duncraft.com/Four-Flower-Frolic-Hummingbird-Feeder-Set>, 2 pages, offered for sale no later than Mar. 27, 2012.

Duncraft, Inc., Hollyhock Hummingbird Feeder, (date unknown) located at <http://www.duncraft.com/Hollyhock-Hummingbird-Feeder>, 2 pages, offered for sale no later than Mar. 27, 2012.

1999 Art Line, Inc. Bird Feeder Catalog (2 pages).

2000 Art Line, Inc. Bird Feeder Product Catalog (2 pages).

2003 Art Line, Inc. Bird Feeder Product Catalog (2 pages).

2005 Edition Birder's Bible Product Catalog (6 pages).

Perky-Pet Products, Co. Bird Feeder Product Catalog, date unknown (4 pages).

1984 Rubbermaid Hummingbird Feeder Product Catalog (3 pages).

Original Ceramic Designs from Opus, Flyer (1 page).

More Birds Bird Feeders & Nectar 2013 Product Catalog (12 pages).

More Birds Bird Feeders & Nectar 2014 New Product Catalog Supplement (4 pages).

2013 Belle Fleur Wild Bird Products Catalog: Modern, Functional & Decorative Feeder Collection (16 pages).

2013 Stokes Select Bird Feeders & Accessories Products Catalog: The most complete collection of bird feeding products (46 pages).

Stokes New Products for 2014 Supplemental Products Catalog (4 pages).

U.S. Appl. No. 29/557,613, filed Mar. 10, 2016, Donegan et al.

U.S. Appl. No. 29/542,433, filed Oct. 14, 2015, Krueger, et al.

U.S. Appl. No. 29/550,811, filed Jan. 7, 2016, Donegan et al.

\* cited by examiner

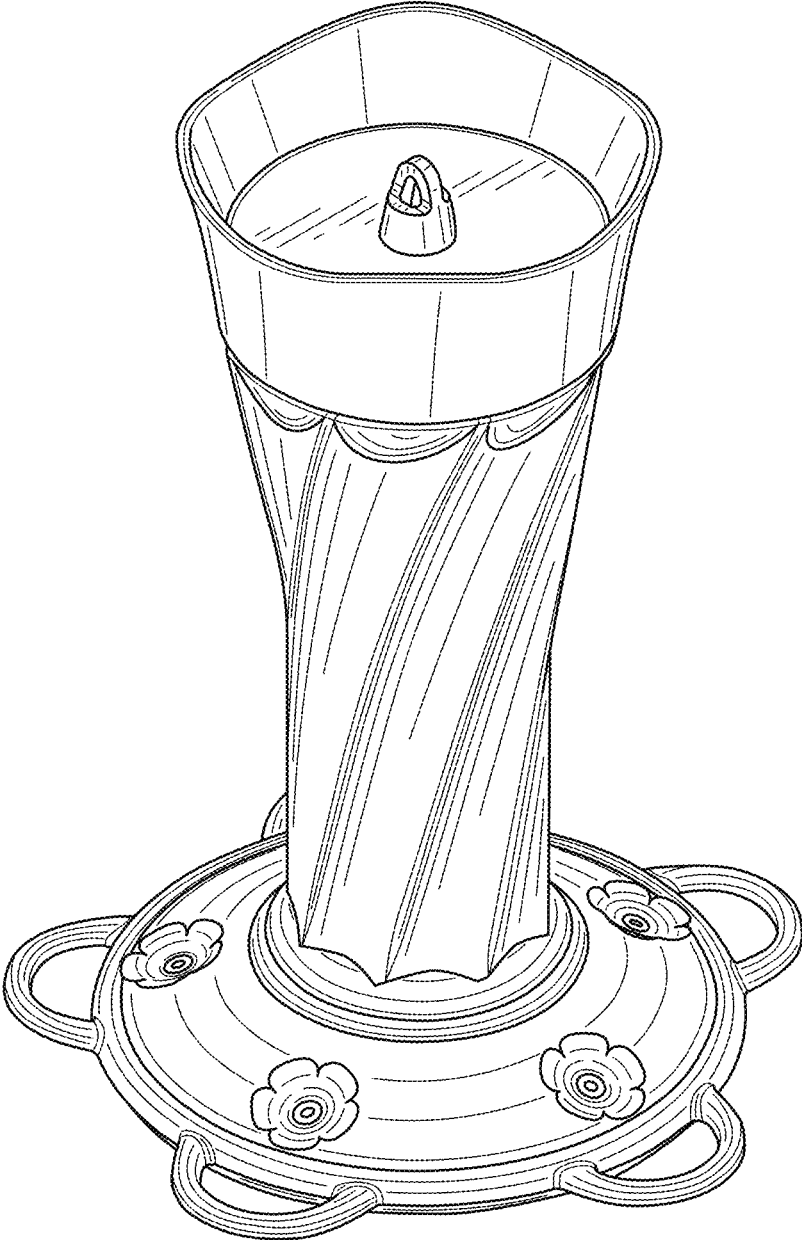

FIG.1



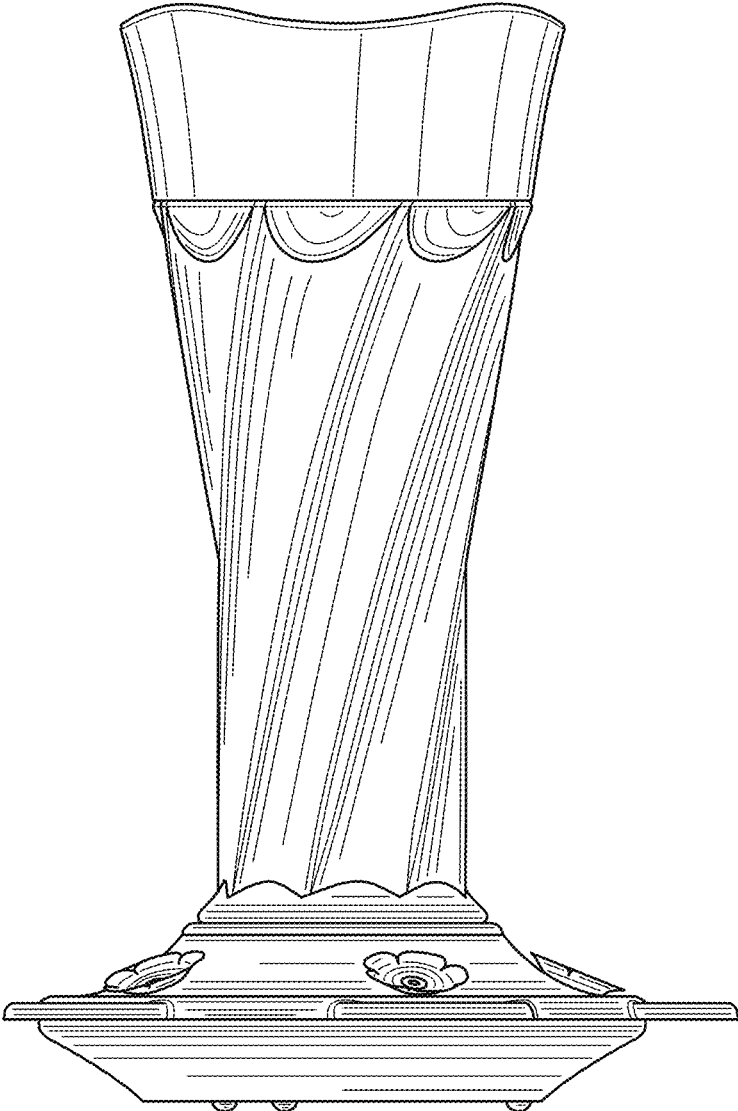

FIG.2

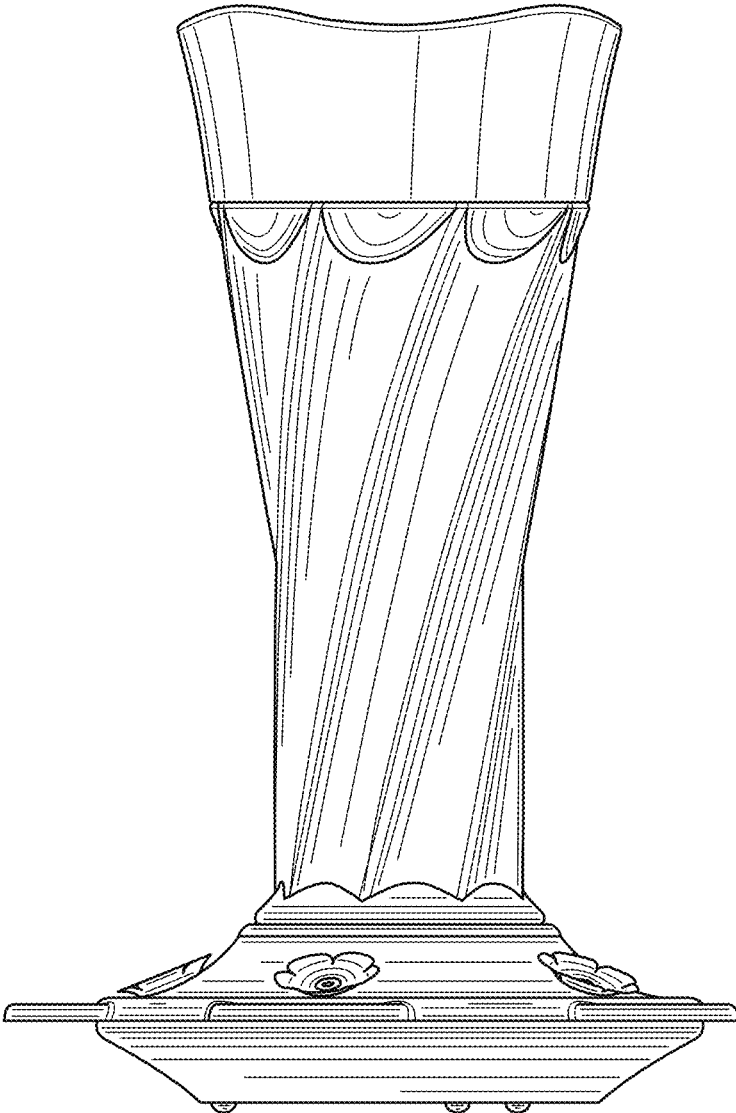

FIG.3

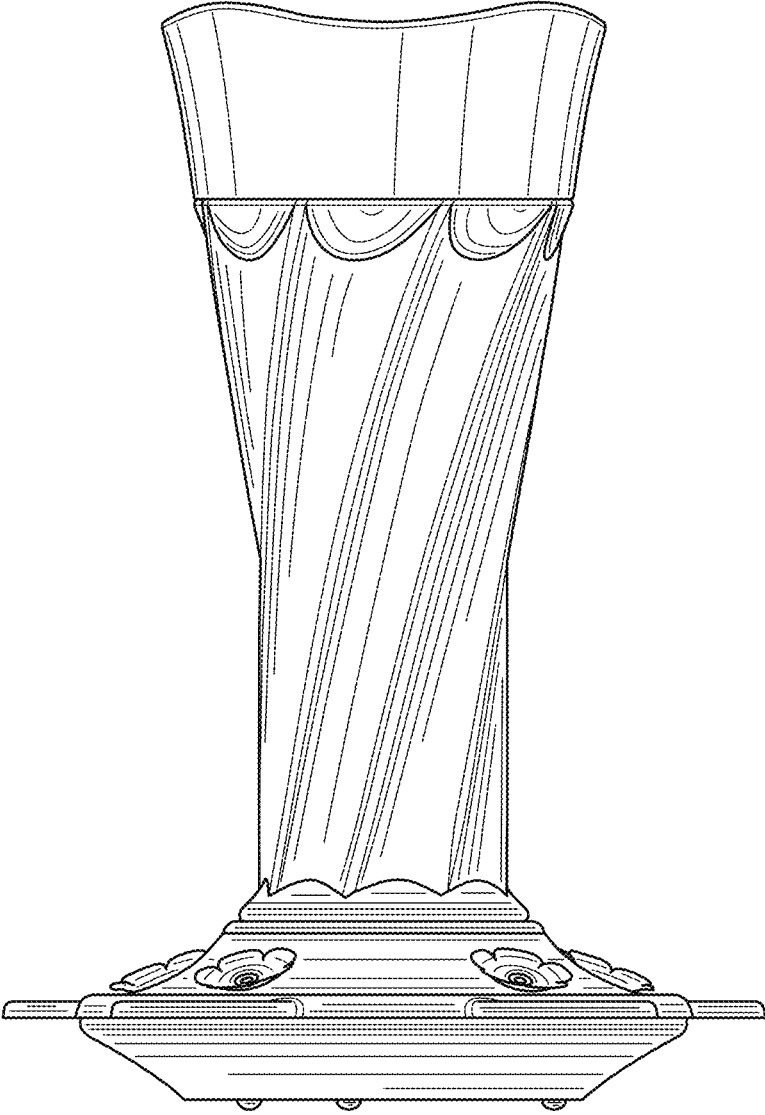

FIG. 4

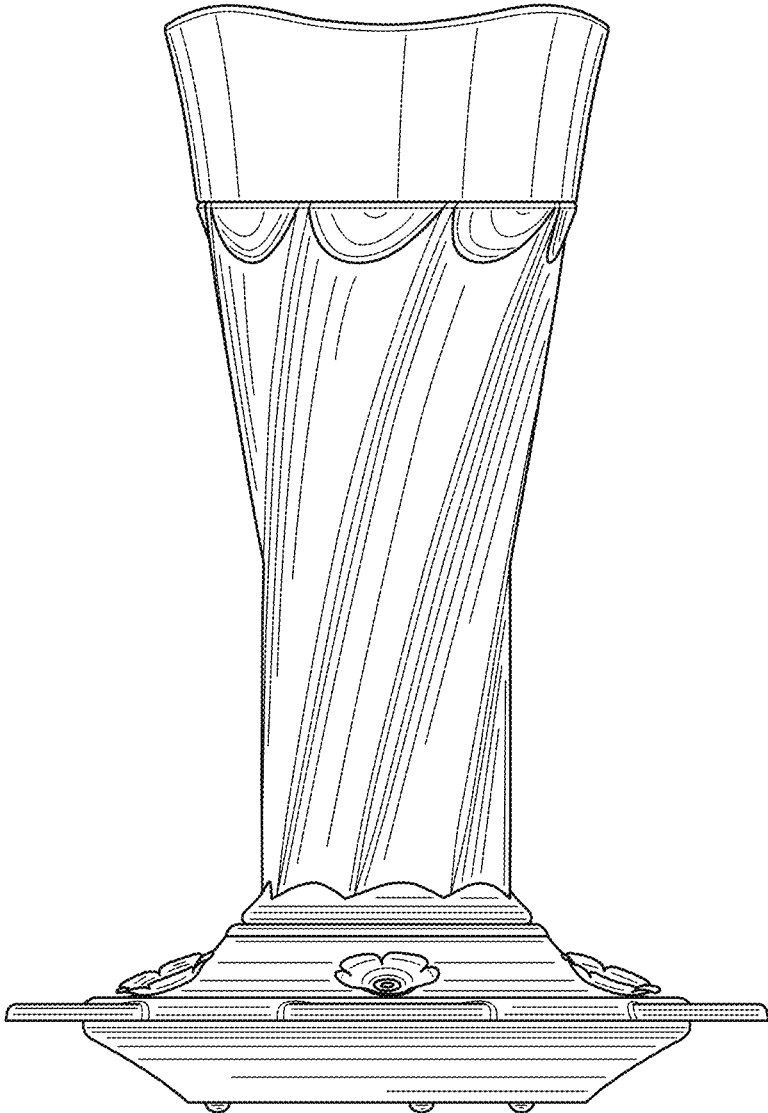

FIG.5

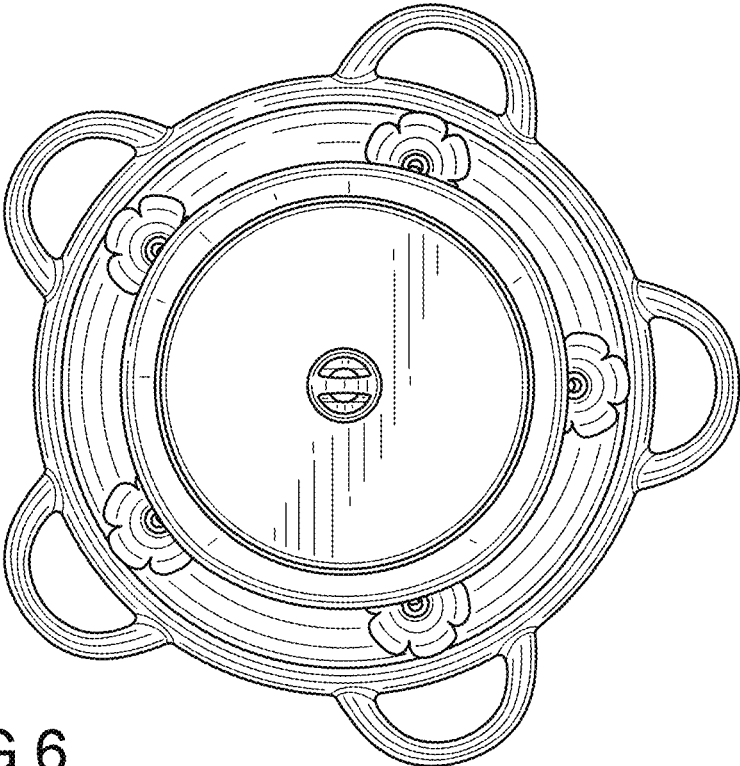

FIG. 6

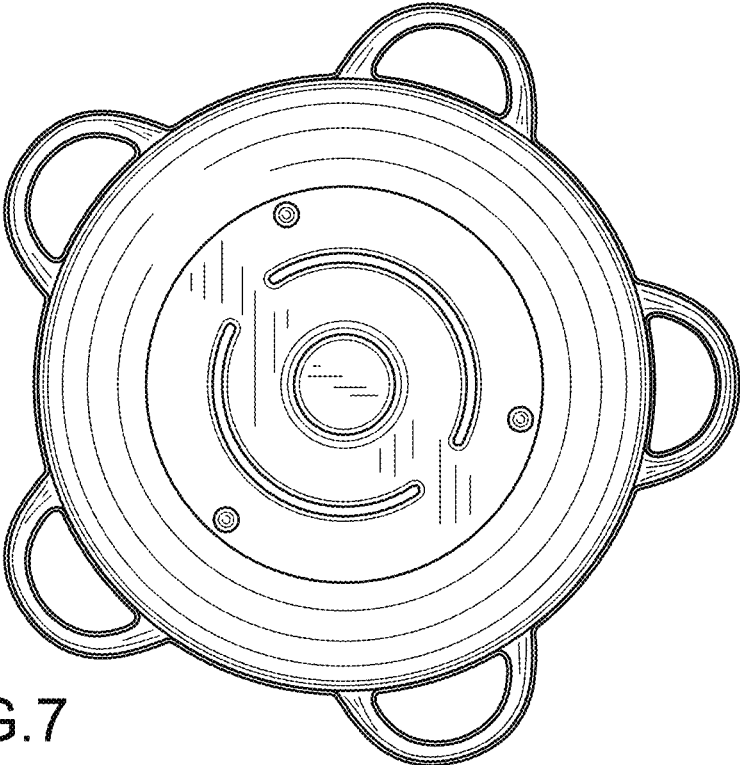

FIG. 7