



US00D772203S

(12) **United States Design Patent**
Zeng

(10) **Patent No.:** **US D772,203 S**

(45) **Date of Patent:** **** Nov. 22, 2016**

(54) **HEADSET**

(71) Applicant: **GN Netcom A/S**, Ballerup (DK)

(72) Inventor: **Bill Zeng**, Xiamen (CN)

(73) Assignee: **GN Netcom A/S** (DK)

(**) Term: **14 Years**

(21) Appl. No.: **29/526,680**

(22) Filed: **May 12, 2015**

(30) **Foreign Application Priority Data**

Nov. 12, 2014 (EM) 002576397-0001

(51) **LOC (10) Cl.** **14-01**

(52) **U.S. Cl.**
USPC **D14/223**

(58) **Field of Classification Search**

USPC D14/205, 249, 240, 188, 192, 223;
D29/112; 2/209; 181/129, 130, 135;
381/380, 381, 370, 377, 378, 374, 385,
381/74; 455/90.3, 575.1

CPC H04R 5/033; H04R 5/0335; H04R 1/10;
H04R 1/1066; H04R 25/00

See application file for complete search history.

(56) **References Cited**

U.S. PATENT DOCUMENTS

D388,093 S *	12/1997	Frengley	D14/223
D480,073 S *	9/2003	Jensen	D14/224
D518,816 S *	4/2006	Naito	D14/205
D520,497 S *	5/2006	Yang	D14/223
7,079,664 B2 *	7/2006	Nassimi	H04R 25/558 381/328
D528,529 S *	9/2006	Rose	D14/138 R
D528,531 S *	9/2006	Rose	D14/138 R
D536,692 S *	2/2007	Alwicker	D14/188
D538,271 S *	3/2007	Kim	D14/223
D538,792 S *	3/2007	Kim	D14/223
D539,782 S *	4/2007	Lee	D14/188

D539,787 S *	4/2007	Kim	D14/223
D552,087 S *	10/2007	Wei	D14/223
D552,596 S *	10/2007	Christopher	D14/205
D553,613 S *	10/2007	Sade	D14/223
D554,626 S *	11/2007	Christopher	D14/223
D555,151 S *	11/2007	Eklund	D14/223
D562,310 S *	2/2008	Moon	D14/223
D564,500 S *	3/2008	Wang	D14/205
D566,103 S *	4/2008	Sade	D14/223
D568,301 S *	5/2008	Kim	D14/205
D573,582 S *	7/2008	Ma	D14/205
D573,983 S *	7/2008	Bang	D14/223
D574,366 S *	8/2008	Sade	D14/223
D575,277 S *	8/2008	Gaarde	D14/205
D581,396 S *	11/2008	Wikel	D14/206
D582,897 S *	12/2008	Christopher	D14/223
D585,430 S *	1/2009	Kim	D14/223
D588,113 S *	3/2009	Bradford	D14/223
D590,377 S *	4/2009	Bradford	D14/223
D590,378 S *	4/2009	Bradford	D14/223
D590,813 S *	4/2009	Bradford	D14/205
D598,900 S *	8/2009	Wikel	D14/223
D603,378 S *	11/2009	Paradise	D14/223

(Continued)

Primary Examiner — Paula Greene

(74) *Attorney, Agent, or Firm* — Altera Law Group, LLC

(57) **CLAIM**

The ornamental design for a headset, as shown and described.

DESCRIPTION

FIG. 1 is a front perspective view of a headset showing my new design.

FIG. 2 is a right view thereof.

FIG. 3 is a left view thereof.

FIG. 4 is a front view thereof.

FIG. 5 is a back view thereof.

FIG. 6 is a top view thereof; and,

FIG. 7 is a bottom view thereof.

The features shown in broken lines depict environmental subject matter only and form no part of the claimed design.

1 Claim, 7 Drawing Sheets

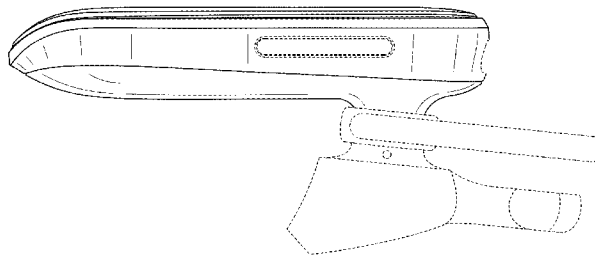
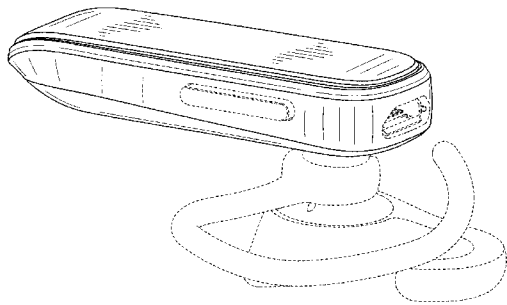

(56)

References Cited

U.S. PATENT DOCUMENTS

D604,722 S *	11/2009	Mistry	D14/223	8,249,287 B2 *	8/2012	Silvestri	H04R 1/1016 381/370
D618,221 S *	6/2010	Fahrendorff	D14/223	8,270,915 B2 *	9/2012	Sanford	H01Q 1/243 343/904
D628,990 S *	12/2010	Pedersen	D14/223	8,285,208 B2 *	10/2012	Terlizzi	H04M 1/05 379/428.02
D634,305 S *	3/2011	Hoggarth	D14/223	D675,600 S *	2/2013	Koch	D14/223
D636,381 S *	4/2011	Liner	D14/223	D693,796 S *	11/2013	Birger	D14/223
7,925,037 B2 *	4/2011	Te Riet	H04M 1/05 381/330	D694,220 S *	11/2013	Lee	D14/223
D637,183 S *	5/2011	March	D14/223	8,611,578 B2 *	12/2013	Kim	H02J 7/0044 379/420.01
D640,242 S *	6/2011	Fahrendorff	D14/223	D707,659 S *	6/2014	Henning	D14/223
D643,420 S *	8/2011	Huang	D14/223	D726,694 S *	4/2015	Behar	D14/223
D645,456 S *	9/2011	Carr	D14/223	D728,533 S *	5/2015	Poulsen	D14/223
D645,458 S *	9/2011	Silvestri	D14/223	D733,689 S *	7/2015	Narita	D14/223
D649,957 S *	12/2011	Fahrendorff	D14/223	D746,267 S *	12/2015	Birger	D14/223
D656,128 S *	3/2012	Park	D14/223	2003/0012396 A1 *	1/2003	Smith	H04R 1/105 381/381
D656,490 S *	3/2012	Birger	D14/223	2007/0116309 A1 *	5/2007	Smith	H04R 1/1016 381/313
8,139,808 B2 *	3/2012	Liu	H04M 1/05 381/330	2008/0013774 A1 *	1/2008	Hosaka	H04R 1/1075 381/380
D657,781 S *	4/2012	Yang	D14/223	2013/0004011 A1 *	1/2013	Hayashida	H04R 1/1016 381/380
D664,950 S *	8/2012	Rye	D14/223				

* cited by examiner

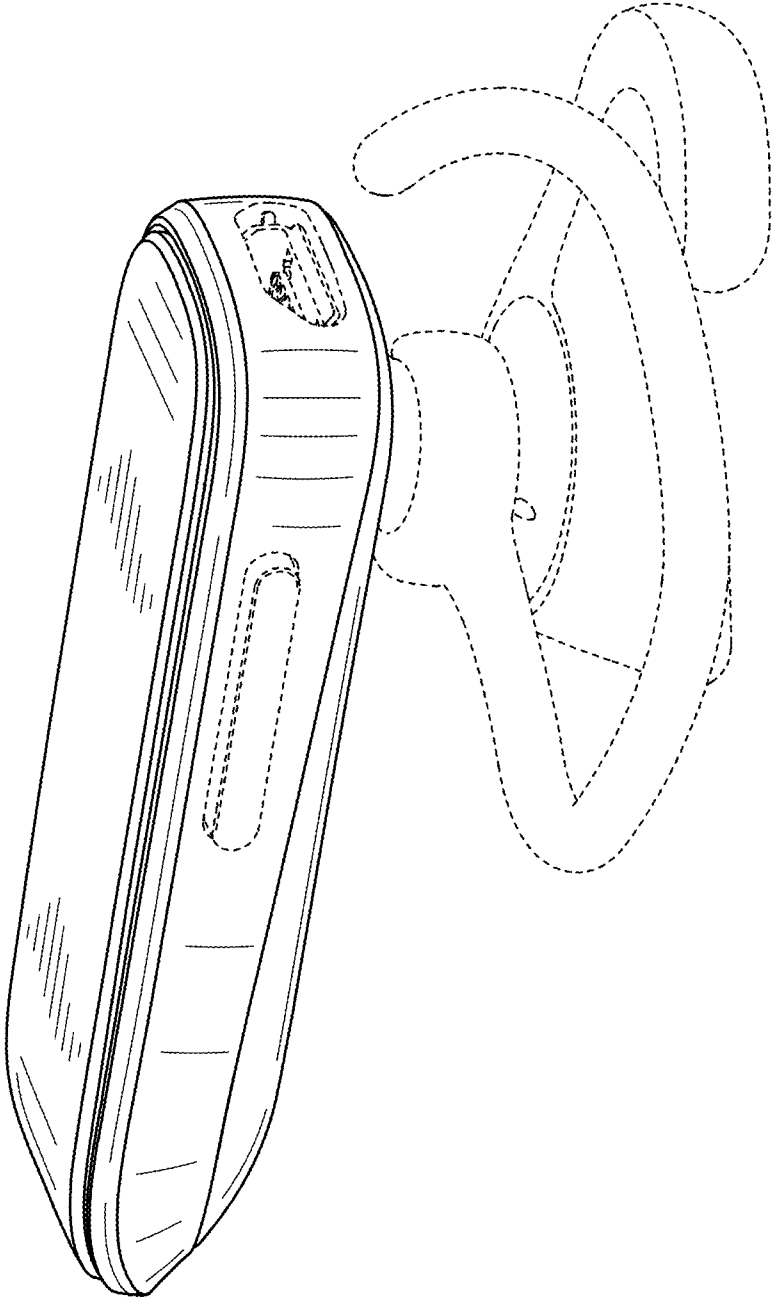

FIG. 1

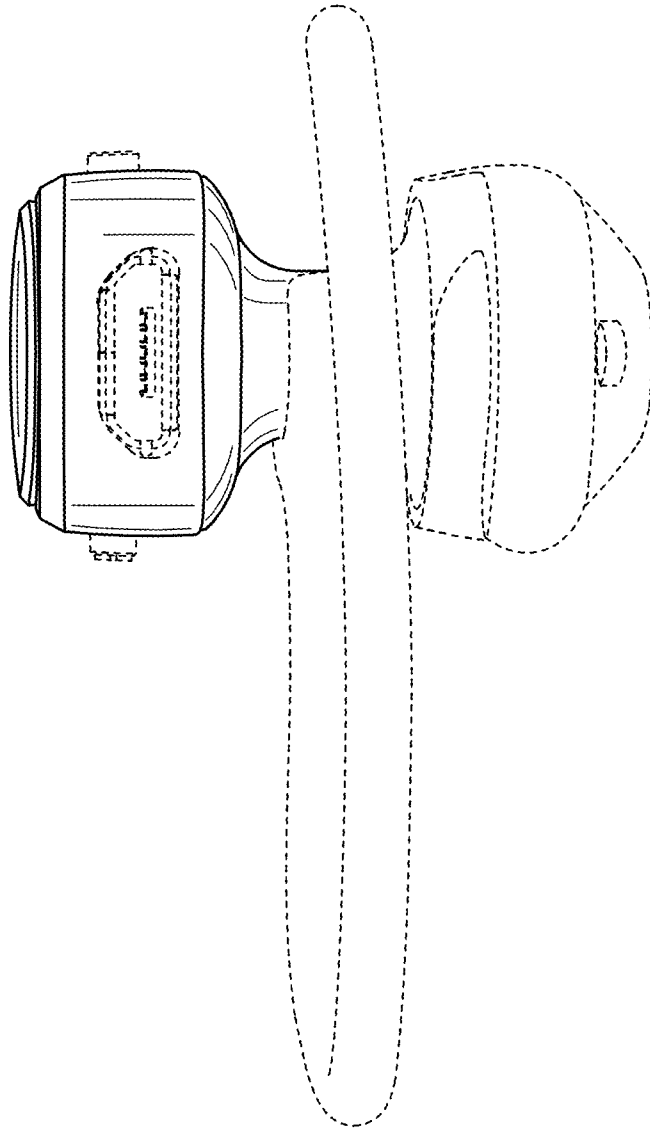

FIG. 2

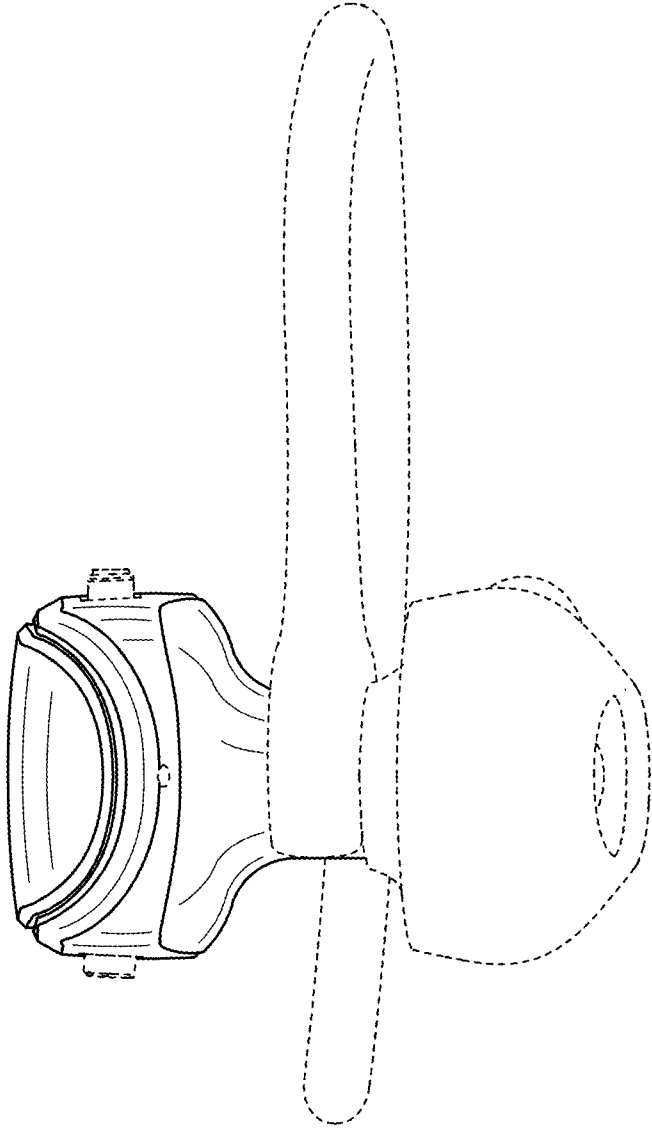

FIG. 3

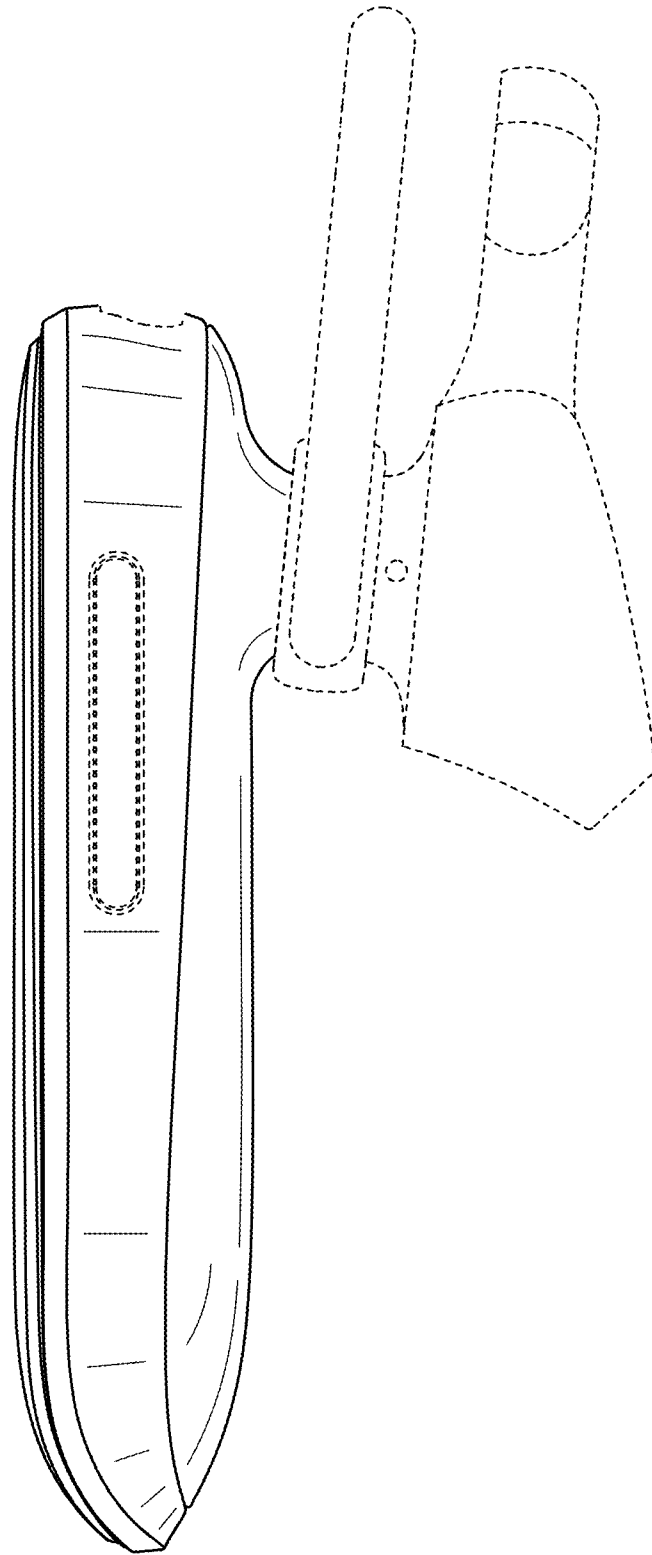

FIG. 4

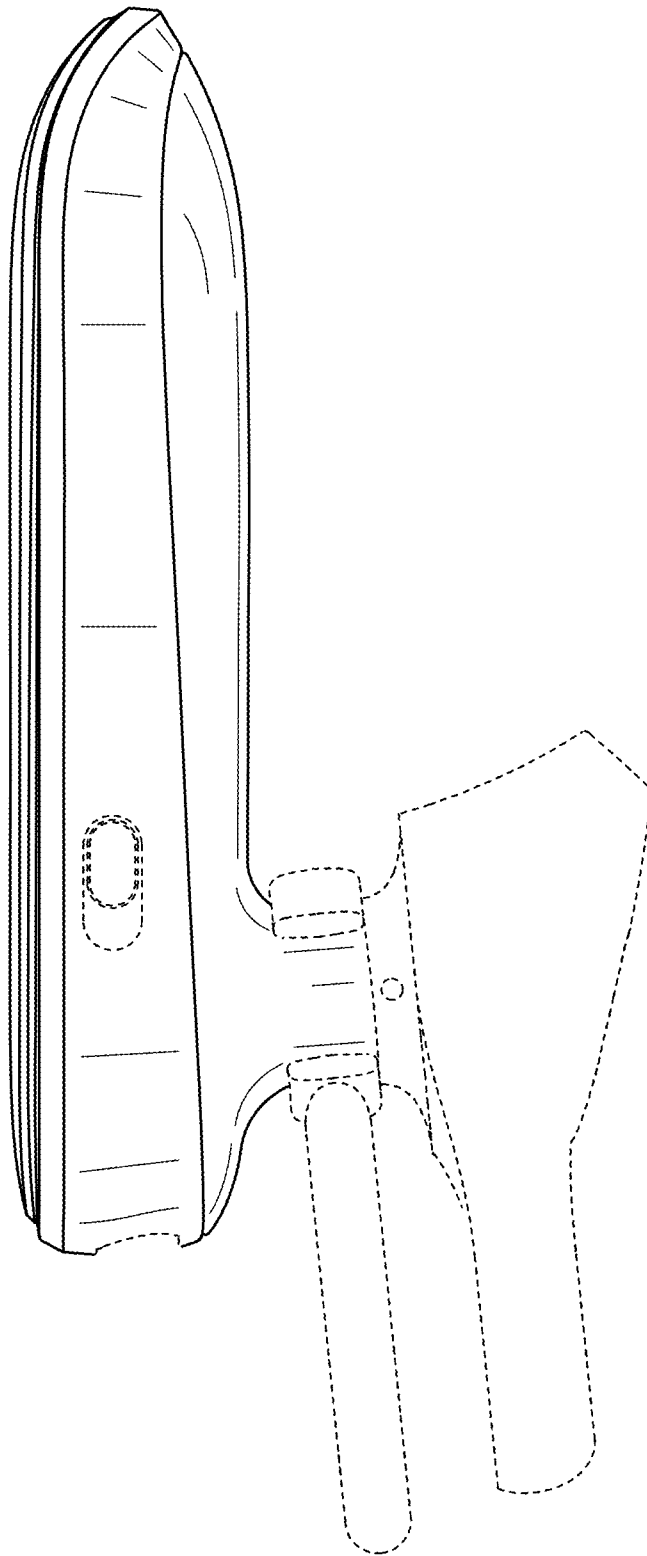

FIG. 5

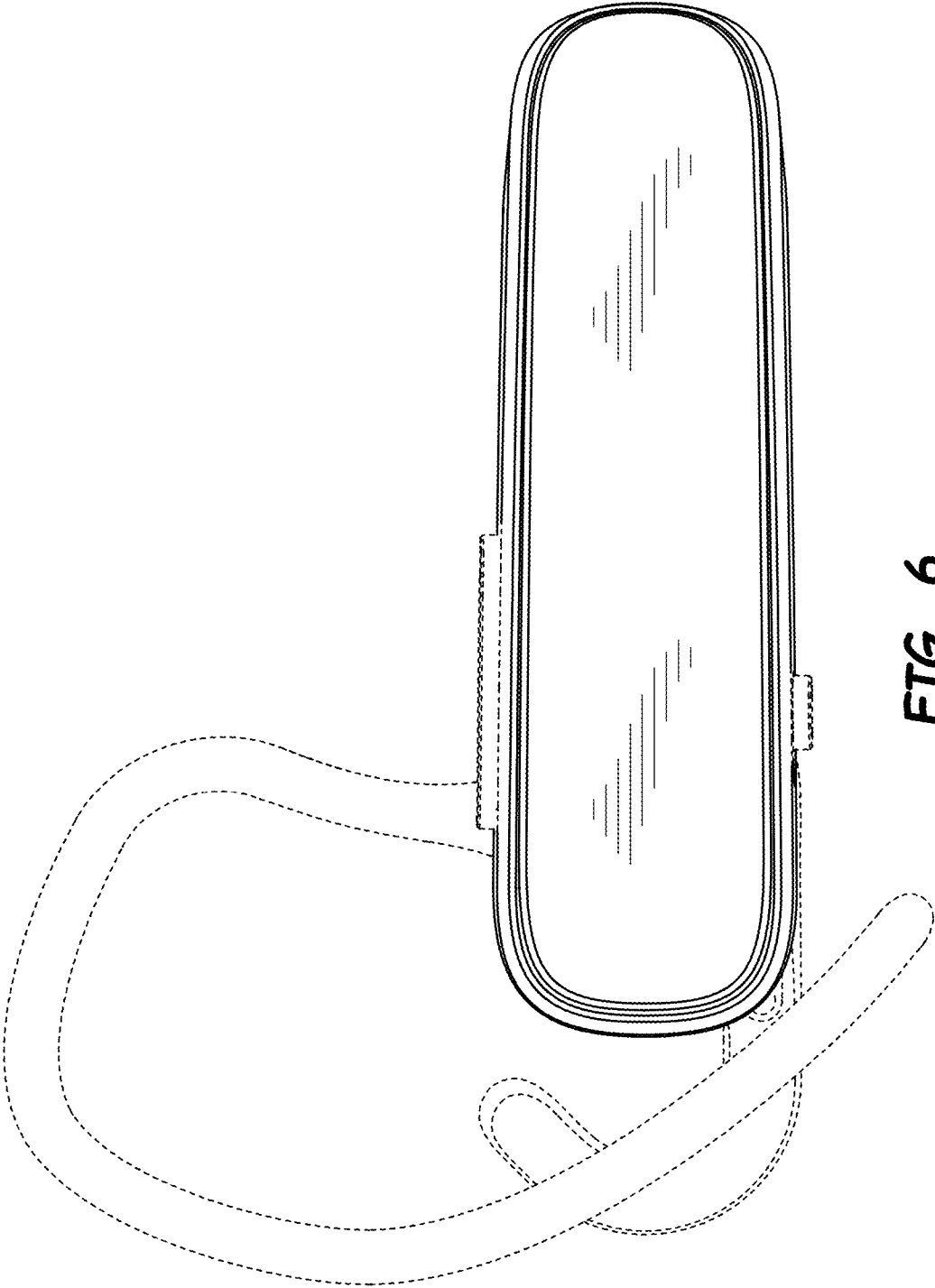

FIG. 6

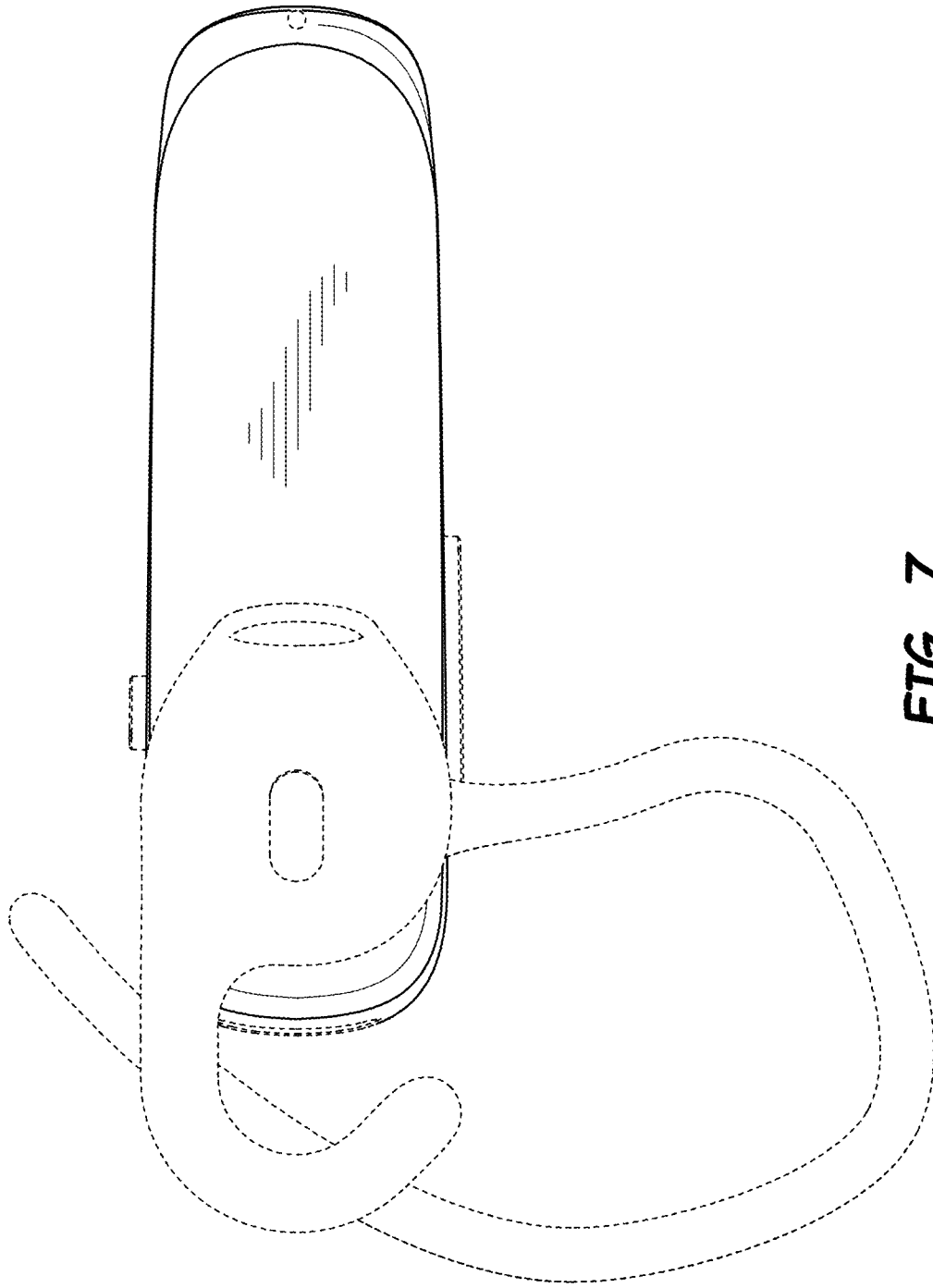

FIG. 7