



US00D874173S

(12) **United States Design Patent** (10) **Patent No.:** **US D874,173 S**
Carter (45) **Date of Patent:** **** Feb. 4, 2020**

(54) **LEFT ARM OR RIGHT ARM CHAISE**

OTHER PUBLICATIONS

(71) Applicant: **Blu Dot Design & Manufacturing, Inc.**, Minneapolis, MN (US)

Blu Dot Catalog No. 16, Designed in Minneapolis, Minnesota, Copyright 2015, 44 pages.

(Continued)

(72) Inventor: **Michael Carter**, Bloomington, MN (US)

Primary Examiner — Kevin K Rudzinski

Assistant Examiner — Paul D Bohannon

(73) Assignee: **Blu Dot Design & Manufacturing, Inc.**, Minneapolis, MN (US)

(74) *Attorney, Agent, or Firm* — Fredrikson & Byron P.A.

(**) Term: **15 Years**

(57) **CLAIM**

(21) Appl. No.: **29/627,310**

I claim the ornamental design for a left arm or right arm chaise, as shown and described.

(22) Filed: **Nov. 26, 2017**

(51) **LOC (12) Cl.** **06-01**

(52) **U.S. Cl.**
USPC **D6/361**

DESCRIPTION

(58) **Field of Classification Search**

USPC D6/349, 361, 377, 378, 381
CPC .. B65B 31/04; A47D 1/00; A47D 1/10; A47C 1/02; A47C 1/14; A47C 1/16; A47C 1/143; A47C 1/146; A47C 1/0342; A47C 3/00; A47C 3/04; A47C 3/14; A47C 3/16; A47C 3/18; A47C 4/00; A47C 4/04; A47C 4/24; A47C 4/50; A47C 4/54; A47C 5/04; A47C 5/12; A47C 7/0217; A47C 7/18; A47C 7/54; A47C 7/62; A47C 7/70; A47C 7/506; A47C 7/744; A47C 15/008; A47C 17/045; A47C 27/086; A47C 31/11; A47C 31/113

FIG. 1 is a front perspective view of a first embodiment of a left arm or right arm chaise of Applicant's design; FIG. 2 is a front elevational view thereof; FIG. 3 is a rear elevational view thereof; FIG. 4 is a first side elevational view thereof; FIG. 5 is a second side elevational view thereof, the second side being opposite the first side; FIG. 6 is a top plan view thereof; FIG. 7 is a bottom plan view thereof; FIG. 8 is a front perspective view of a second embodiment of a left arm or right arm chaise of Applicant's design, the second embodiment being a mirror image of the first embodiment; FIG. 9 is a front elevational view thereof; FIG. 10 is a rear elevational view thereof; FIG. 11 is a first side elevational view thereof; FIG. 12 is a second side elevational view thereof, the second side being opposite the first side; FIG. 13 is a top plan view thereof; and, FIG. 14 is a bottom plan view thereof.

See application file for complete search history.

Where included, broken lines showing environment or structure are for illustrative purposes only and form no part of the claimed design.

(56) **References Cited**

U.S. PATENT DOCUMENTS

D174,828 S	5/1955	Michlin
D176,938 S	2/1956	Wilson
3,695,690 A	10/1972	Carson
D234,731 S	4/1975	McDonald
D239,580 S	4/1976	Robertson et al.
D241,590 S	9/1976	Kaplan

(Continued)

1 Claim, 14 Drawing Sheets

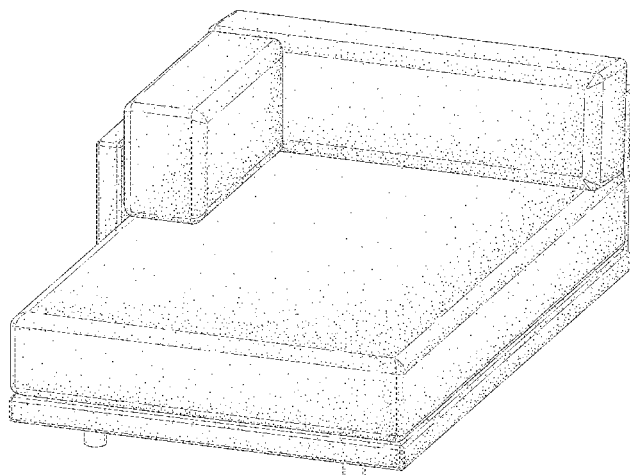

(56)

References Cited

U.S. PATENT DOCUMENTS

D255,513	S	6/1980	Collins	
D268,970	S *	5/1983	Mascheroni	D6/378
D269,482	S *	6/1983	Ungaro	D6/361
D270,308	S	8/1983	Aronowitz et al.	
D360,310	S	7/1995	Stamberg et al.	
D382,124	S	8/1997	Chandler	
D399,661	S	10/1998	Smith	
D404,930	S *	2/1999	Gibson	D6/377
D431,381	S *	10/2000	Gomez	D6/361
D432,808	S *	10/2000	Binder	D6/381
D446,039	S *	8/2001	Gomez	D6/381
D448,196	S	9/2001	Gomez	
D448,946	S	10/2001	Goetz	
D460,284	S	7/2002	Natuzzi et al.	
D484,712	S *	1/2004	Gomez	D6/377
D484,713	S *	1/2004	Gomez	D6/381
D498,064	S	11/2004	Gomez	
D498,941	S	11/2004	Ricci	
D559,003	S	1/2008	Lissoni	
D561,496	S	2/2008	Kreiss	
D562,022	S *	2/2008	Hackethal	D6/381
D566,417	S *	4/2008	Mourgue	D6/381
D576,818	S *	9/2008	Kreiss	D6/381
D584,900	S	1/2009	Hackethal et al.	
D585,200	S	1/2009	Lissoni	
D586,146	S *	2/2009	Mourgue	D6/381
D586,578	S *	2/2009	Mourgue	D6/381
D587,028	S *	2/2009	Mourgue	D6/381
D587,029	S *	2/2009	Mourgue	D6/381
D588,827	S *	3/2009	Mourgue	D6/381
D590,166	S *	4/2009	Natuzzi	D6/381
D591,071	S *	4/2009	Weiss	D6/381
D614,876	S	5/2010	Metcalf et al.	
D618,935	S	7/2010	Metcalf et al.	
D647,317	S	10/2011	Urquiola	
D655,935	S *	3/2012	Sempe	D6/381
D666,424	S	9/2012	Carter, III	
D685,202	S	7/2013	Sage	
D688,475	S	8/2013	Blet et al.	
D698,173	S *	1/2014	Caldwell	D6/378
D698,177	S *	1/2014	Nguyen	D6/381
D698,178	S *	1/2014	Nguyen	D6/381
D698,179	S	1/2014	Nguyen et al.	
D699,456	S	2/2014	Bosman	
D720,142	S	12/2014	Nigro	
D725,921	S	4/2015	Banda	
D736,535	S *	8/2015	Foersom	D6/377
D749,862	S	2/2016	Polk-Kuku	
D763,000	S *	8/2016	King	D6/377
D763,590	S *	8/2016	King	D6/377
D763,591	S *	8/2016	King	D6/377
D763,592	S *	8/2016	King	D6/378
D781,610	S *	3/2017	King	D6/377
D800,460	S	10/2017	Rockwell et al.	
D802,323	S *	11/2017	Binfare	D6/381
D807,655	S	1/2018	Webb	
D807,660	S	1/2018	Hughes	
D815,443	S	4/2018	Bozzoli	
D815,851	S	4/2018	Rafieha	
D834,849	S *	12/2018	Binfare'	D6/378
D842,617	S *	3/2019	Carter	D6/349
D843,749	S *	3/2019	Aubry	D6/369
D849,438	S *	5/2019	Williams, Jr.	D6/381
D849,439	S *	5/2019	Williams, Jr.	D6/381
D850,141	S *	6/2019	King	D6/381
D850,142	S *	6/2019	King	D6/381
2011/0010847	A1	1/2011	Murphy	

OTHER PUBLICATIONS

Blu Dot Catalog No. 17, Designed in Minneapolis, Minnesota, Copyright 2015, 52 pages.
 Blu Dot Catalog No. 18, Designed in Minneapolis, Minnesota, Copyright 2015, 51 pages.
 Blu Dot Catalog No. 19, Designed in Minneapolis, Minnesota, Copyright 2016, 54 pages.
 Sunday Small Ottoman—Small Upholstered Ottoman_Blu Dot. [online] Retrieved Aug. 1, 2018 from URL: <https://www.bludot.com/sunday-small-ottoman.html>.
 Kipton Ottoman. Arhaus Furniture. [online] Retrieved Aug. 1, 2018 from URL: <https://www.arhaus.com/furniture/living-room-furniture/all-living-room-furniture/kipton-ottoman/?Fabric+Name=PLUSH%20LINEN&Width=41%22&>.

* cited by examiner

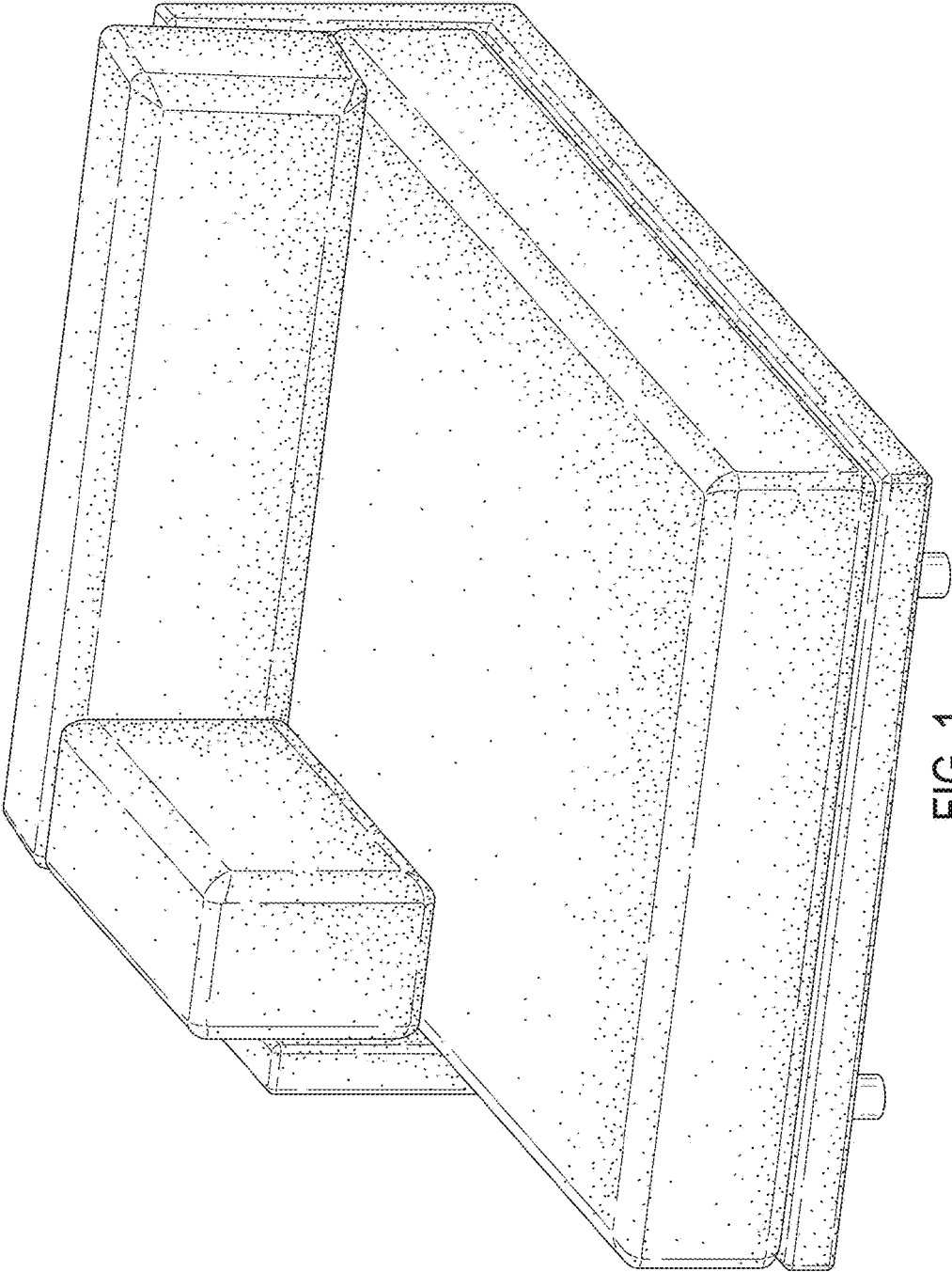

FIG. 1

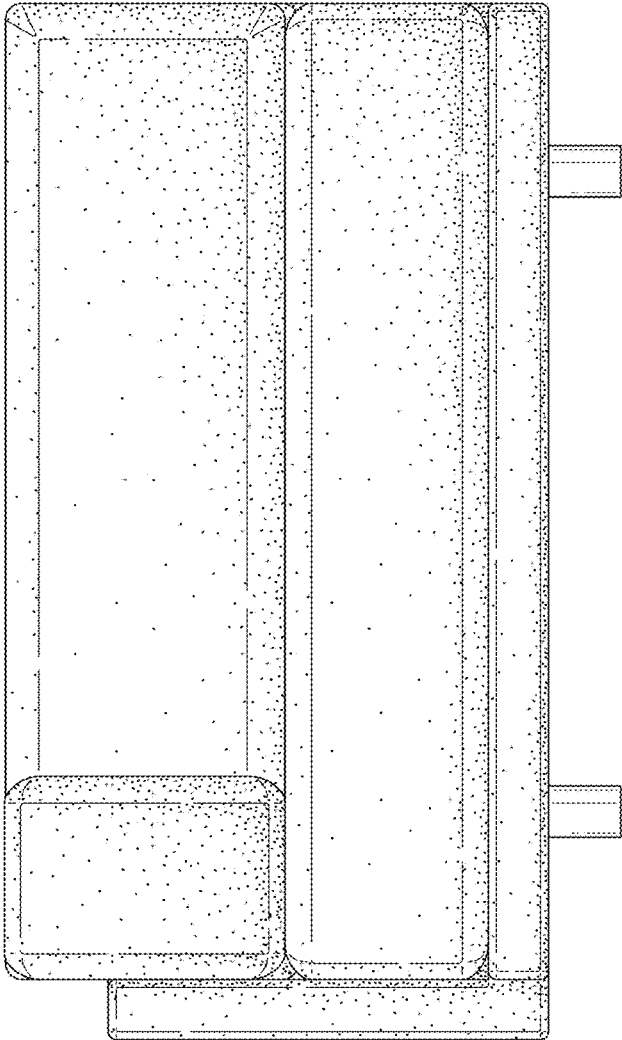

FIG. 2

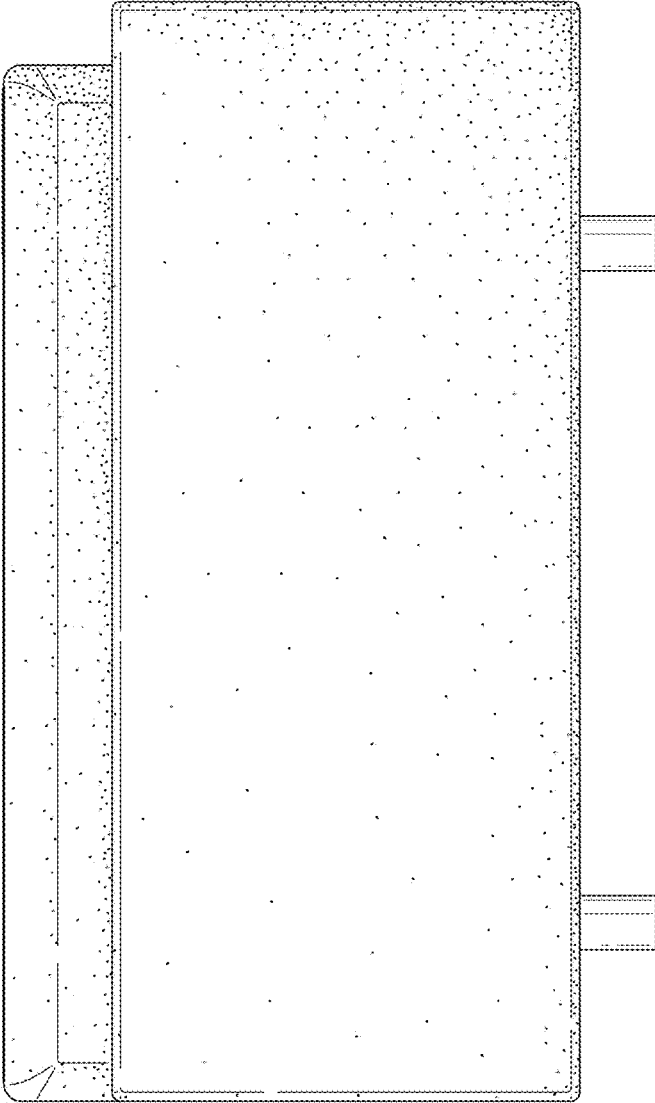

FIG. 3

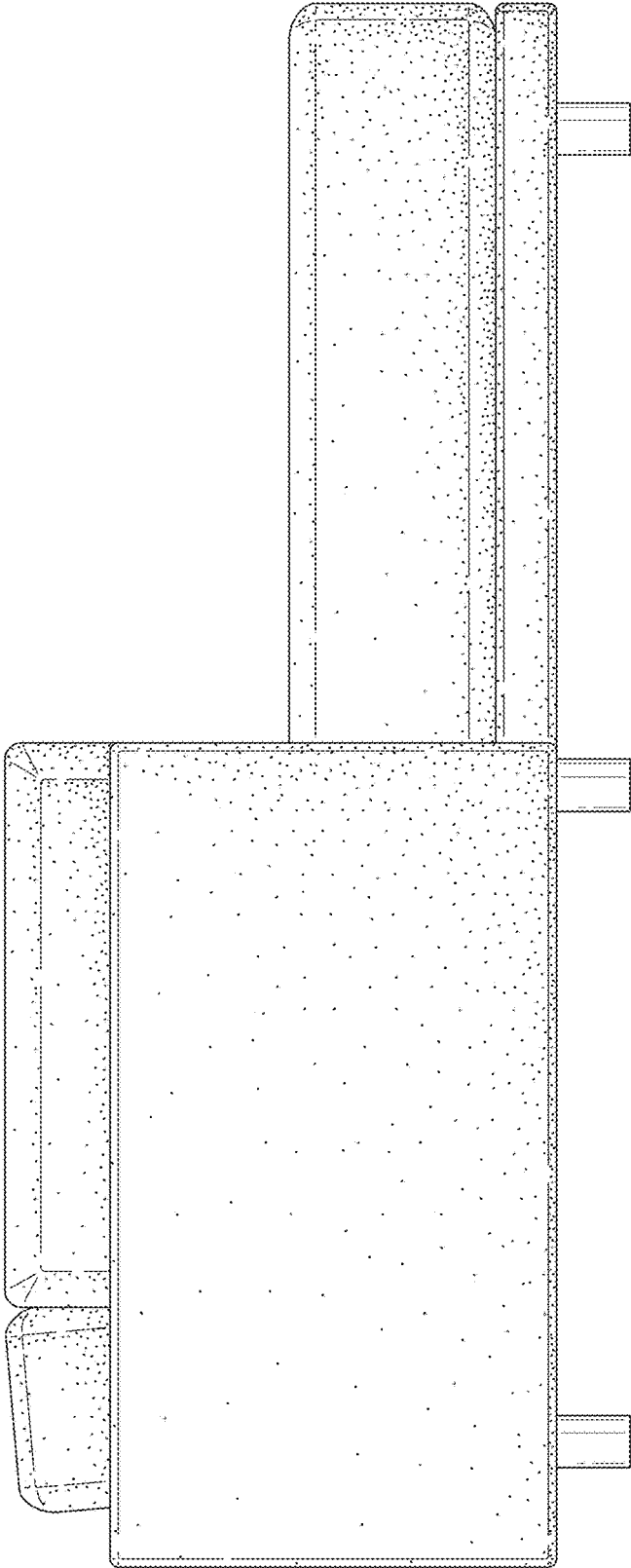

FIG. 4

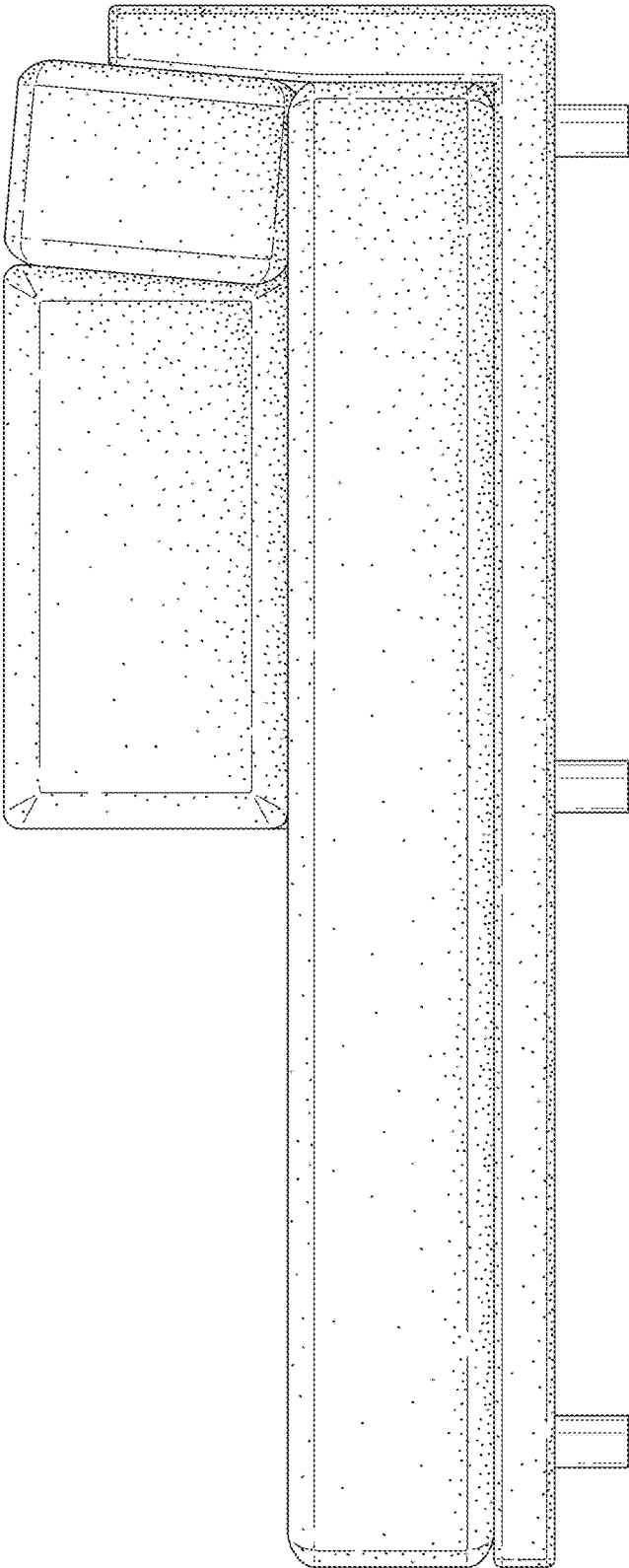

FIG. 5

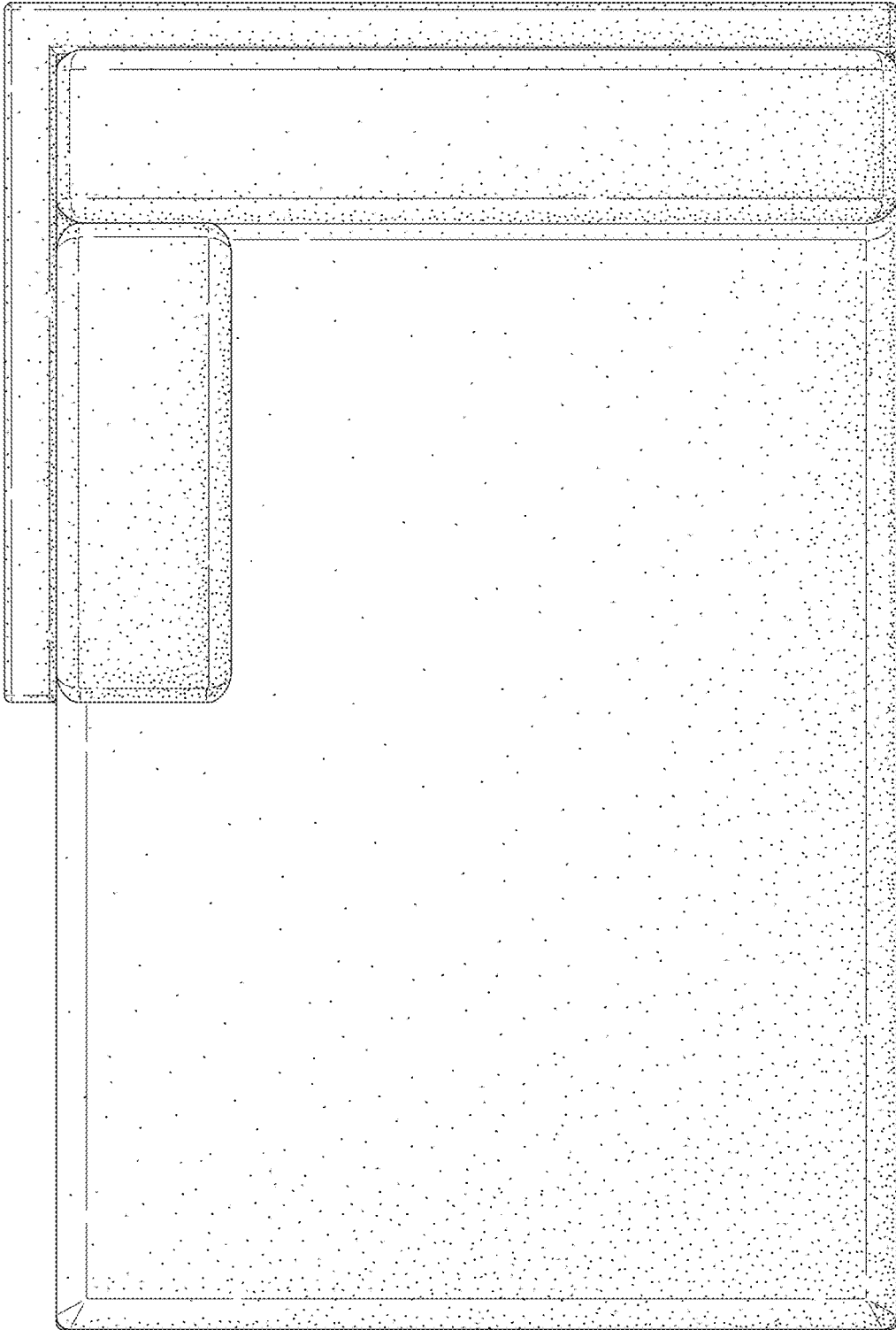

FIG. 6

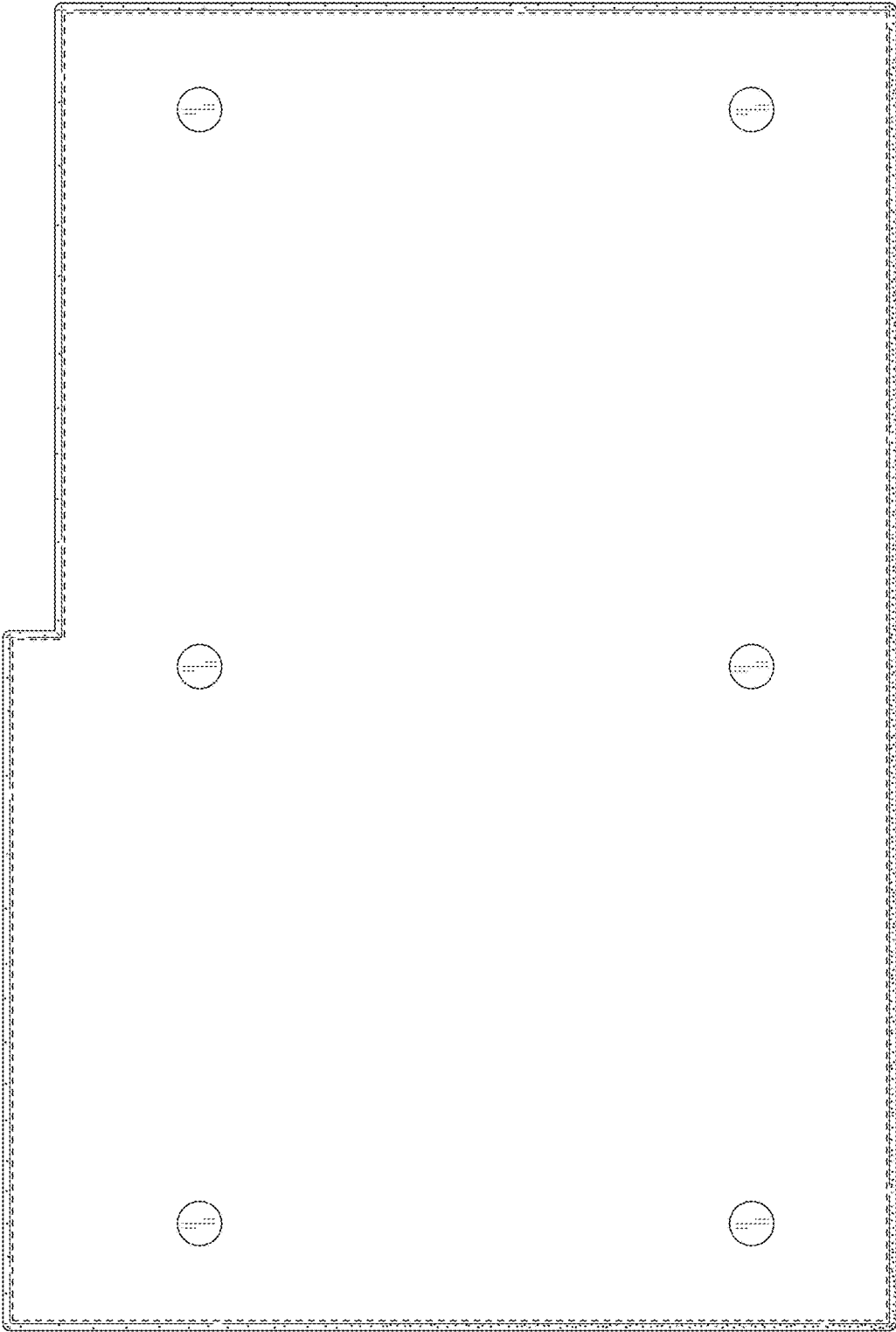

FIG. 7

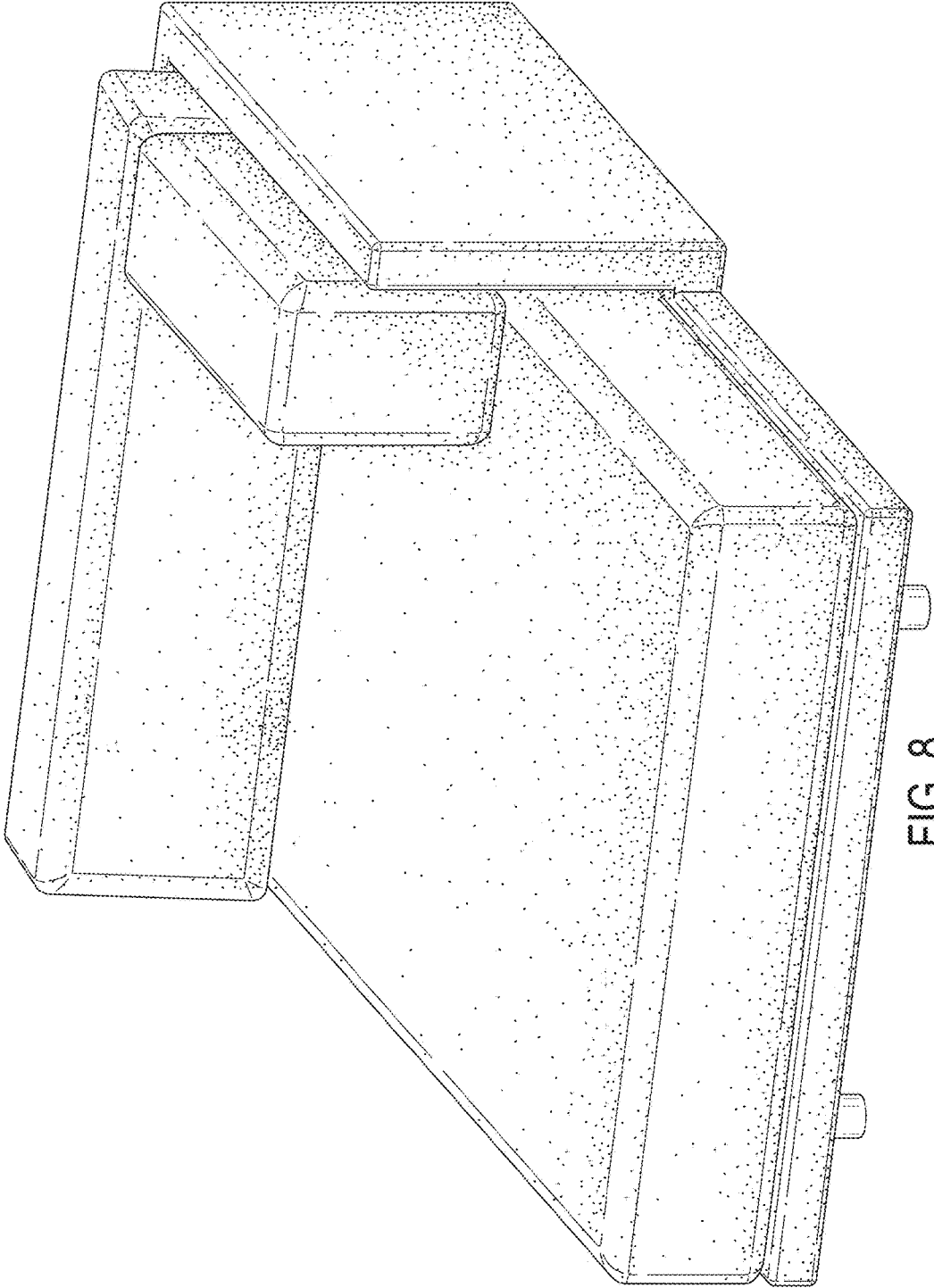

FIG. 8

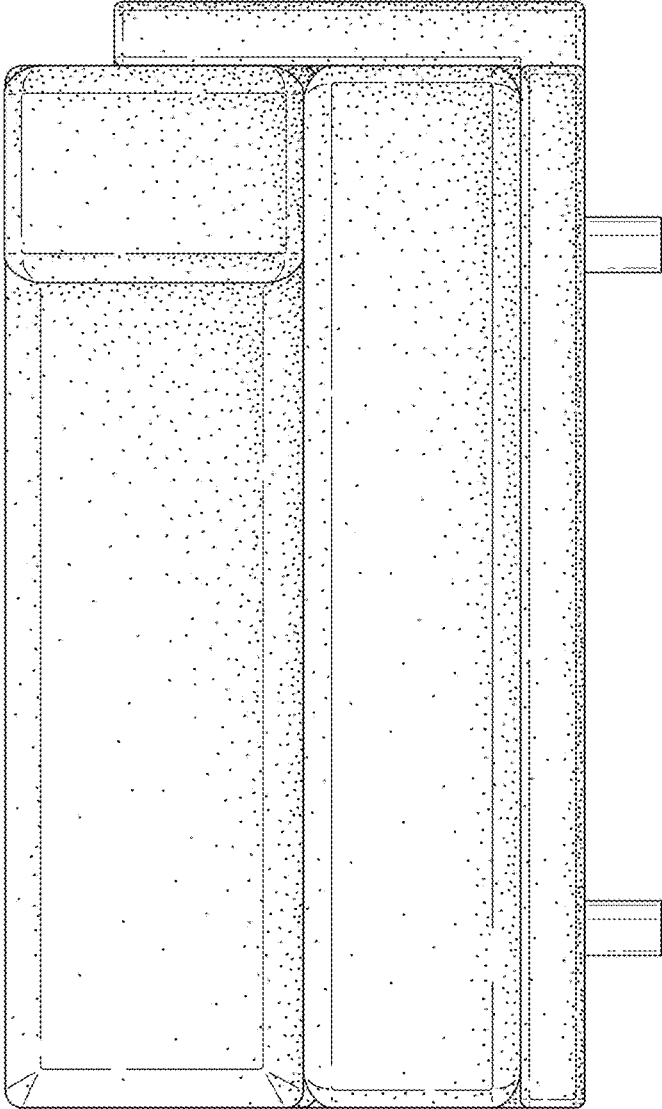

FIG. 9

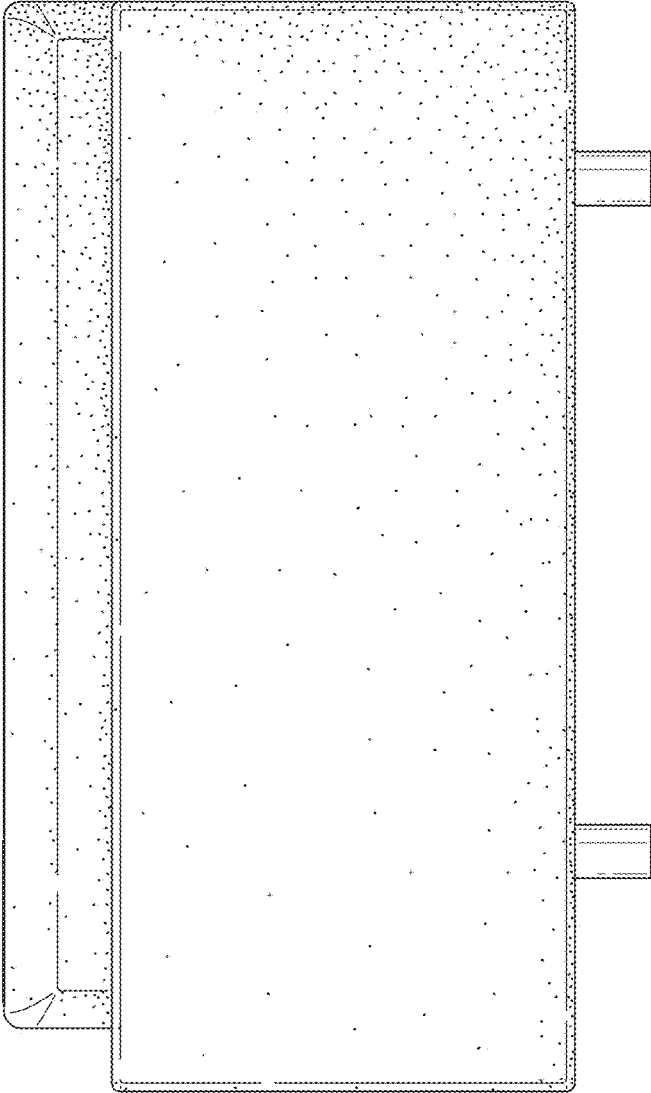

FIG. 10

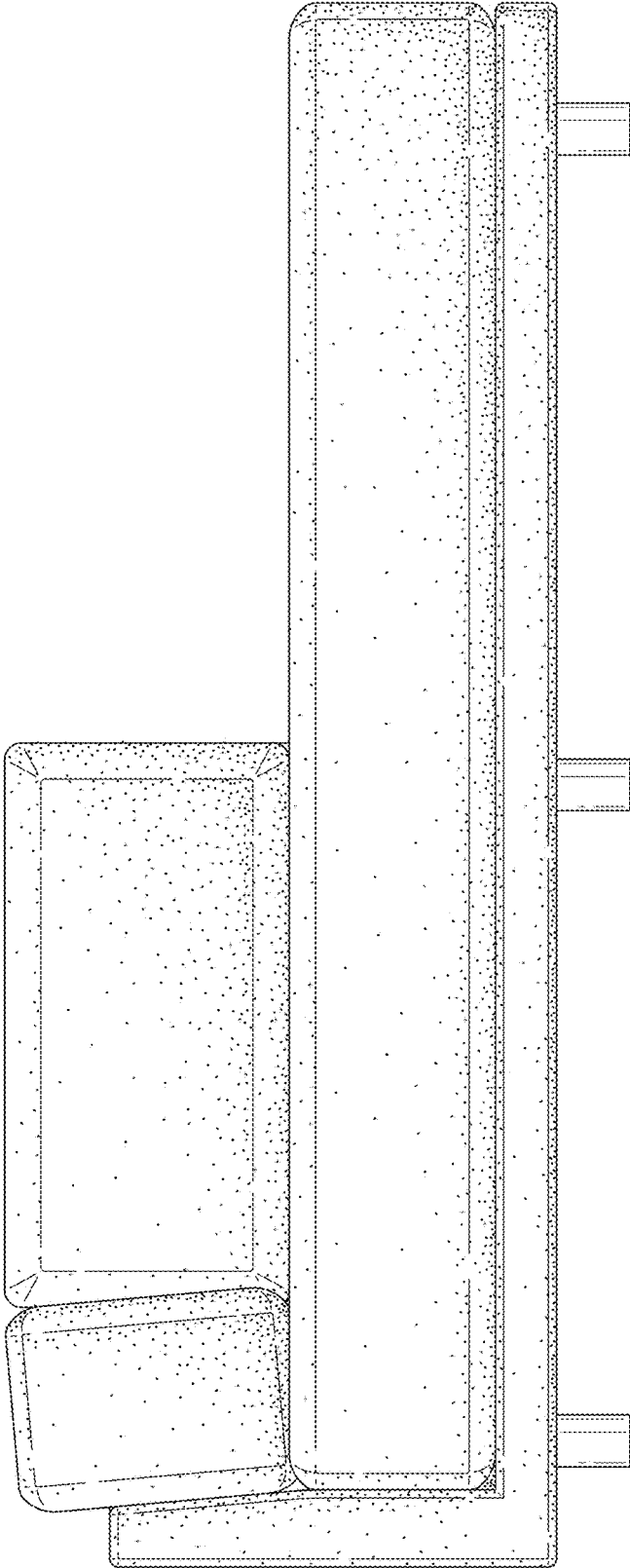

FIG. 11

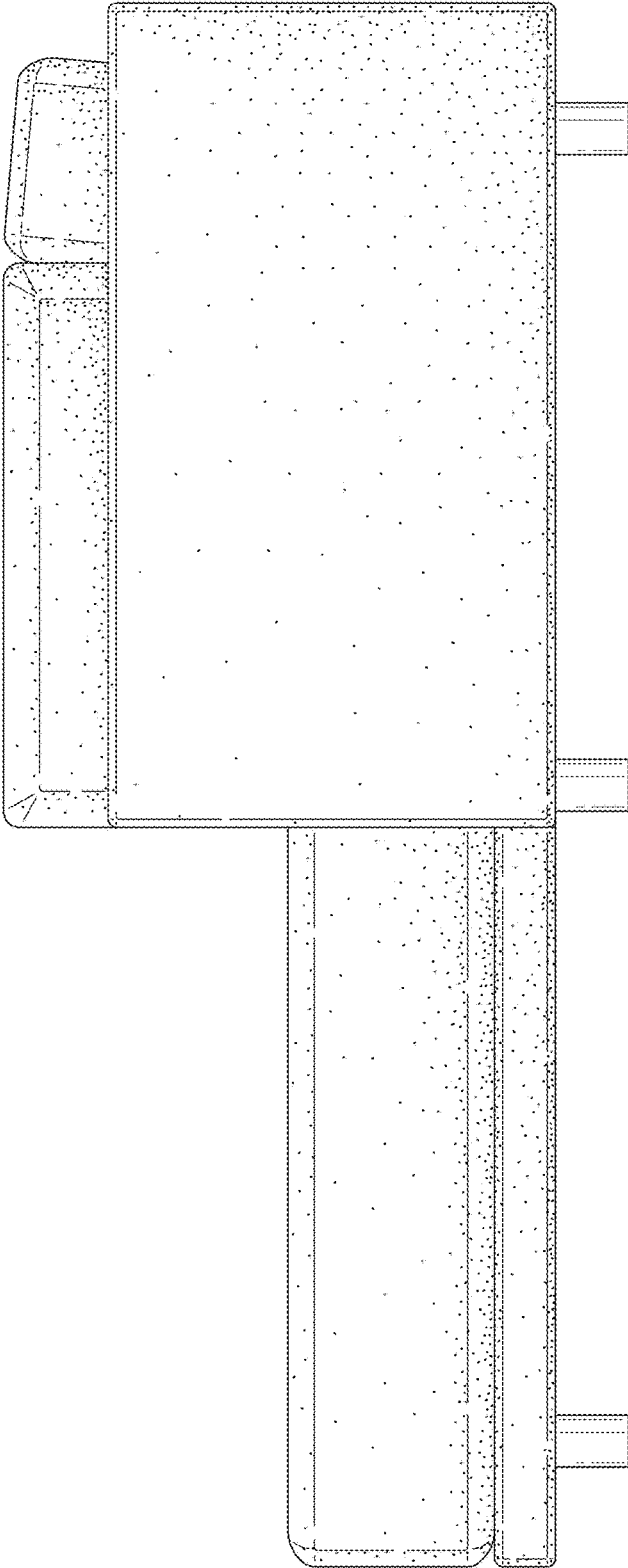

FIG. 12

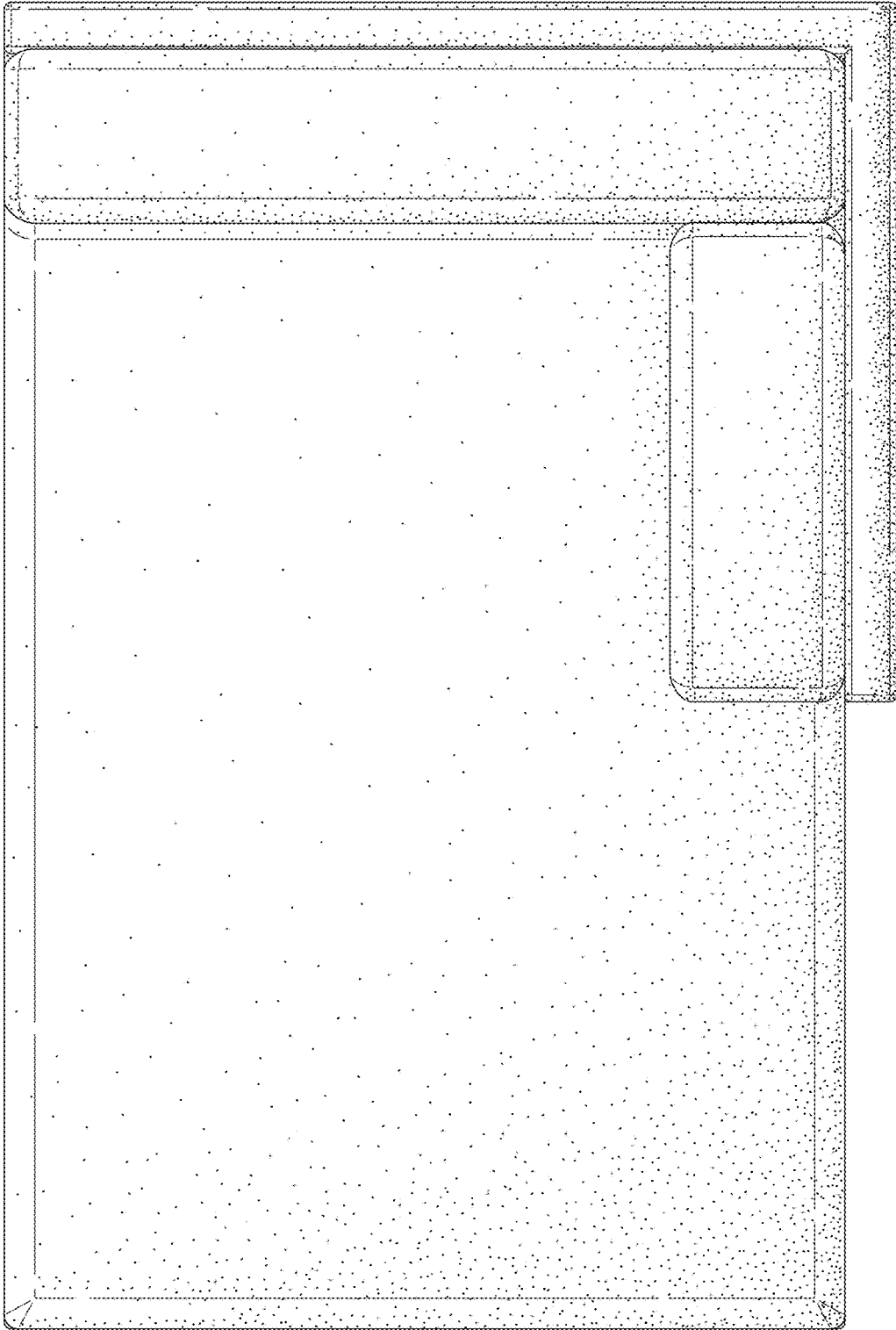

FIG. 13

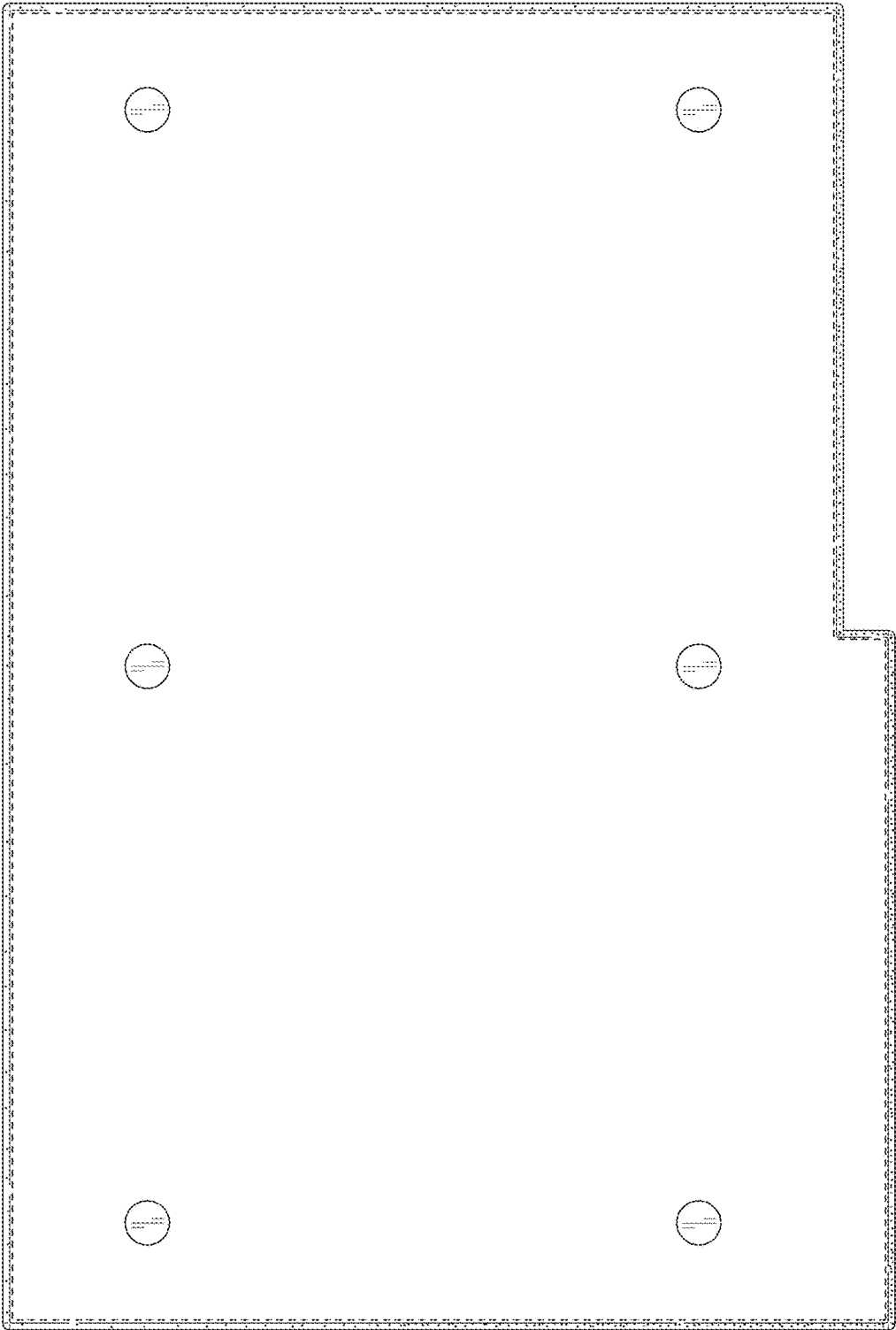

FIG. 14