



US00D878832S

(12) **United States Design Patent**
Cohen

(10) **Patent No.:** **US D878,832 S**

(45) **Date of Patent:** **** Mar. 24, 2020**

- (54) **DISPLAY STAND ASSEMBLY**
- (71) Applicant: **Solaray LLC**, Sapulpa, OK (US)
- (72) Inventor: **Randall P. Cohen**, Newton, PA (US)
- (73) Assignee: **Solaray LLC**, Sapulpa, OK (US)
- (**) Term: **15 Years**
- (21) Appl. No.: **29/627,130**

| | | | |
|--------------|---------|--------------|--------|
| 4,442,778 A | 4/1984 | Lang | |
| D282,033 S * | 1/1986 | Gray | D6/680 |
| 4,632,474 A | 12/1986 | Ingersoll | |
| 4,796,960 A | 1/1989 | Candelas | |
| 4,842,149 A | 6/1989 | Vining | |
| 4,850,658 A | 7/1989 | Sandor | |
| 4,957,206 A | 9/1990 | Banko et al. | |

(Continued)

Primary Examiner — Kelley A Donnelly
(74) *Attorney, Agent, or Firm* — Connie R. Masters

- (22) Filed: **Nov. 22, 2017**
- (51) **LOC (12) Cl.** **06-06**
- (52) **U.S. Cl.**
USPC **D6/677**
- (58) **Field of Classification Search**
USPC D6/300–301, 332, 672–673, 677, 677.1,
D6/678, 678.1
CPC A47B 1/00; A47B 49/00; A47F 1/12
See application file for complete search history.

(57) **CLAIM**

The ornamental design for a display stand assembly, as shown and described.

DESCRIPTION

FIG. 1 is a perspective view of a first embodiment of a display stand assembly of my design;
 FIG. 2 is a front view thereof;
 FIG. 3 is a side view thereof;
 FIG. 4 is a top view thereof;
 FIG. 5 is a perspective view of a second embodiment of a display stand assembly of my design;
 FIG. 6 is a front view thereof;
 FIG. 7 is a rear view thereof;
 FIG. 8 is a side view thereof;
 FIG. 9 is a top view thereof;
 FIG. 10 is a perspective view of a third embodiment of a display stand assembly of my design;
 FIG. 11 is a front view thereof;
 FIG. 12 is a side view thereof;
 FIG. 13 is a top view thereof;
 FIG. 14 is a perspective view of a fourth embodiment of a display stand assembly of my design;
 FIG. 15 is a front view thereof;
 FIG. 16 is a rear view thereof;
 FIG. 17 is a side view thereof; and,
 FIG. 18 is a top view thereof.

(56) **References Cited**
U.S. PATENT DOCUMENTS

| | | |
|-------------|---------|------------|
| 451,722 A | 5/1891 | Evans |
| 766,629 A | 8/1904 | Koehler |
| D51,055 S | 7/1917 | Board |
| 1,416,566 A | 5/1922 | McCleary |
| 1,481,682 A | 1/1924 | Buckingham |
| 1,686,291 A | 10/1928 | Moore |
| 2,221,704 A | 11/1940 | Farley |
| 2,965,429 A | 12/1960 | Stanger |
| 3,092,258 A | 6/1963 | Bleed |
| 3,219,301 A | 11/1965 | Robinson |
| 3,517,905 A | 6/1970 | Nestegard |
| 3,538,863 A | 11/1970 | Howard |
| 3,685,664 A | 8/1972 | Kramer |
| 3,756,421 A | 9/1973 | Wilkins |
| 3,788,241 A | 1/1974 | Ravreby |
| 3,856,370 A | 12/1974 | Burrell |
| 3,931,894 A | 1/1976 | Murphy |
| 4,126,366 A | 11/1978 | Handler |
| 4,379,432 A | 4/1983 | Grossman |

1 Claim, 18 Drawing Sheets

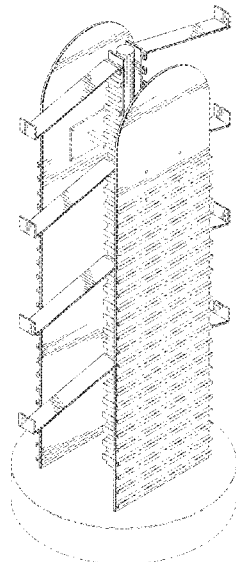

(56)

References Cited

U.S. PATENT DOCUMENTS

| | | | | | | | |
|--------------|------|---------|-------------------|-------|-------------|--|--|
| 4,961,506 | A | 10/1990 | Lang | | | | |
| 5,038,506 | A | 8/1991 | Liljeqvist et al. | | | | |
| 5,054,624 | A | 10/1991 | Camp | | | | |
| 5,135,293 | A | 8/1992 | St-Germain | | | | |
| 5,147,119 | A | 9/1992 | Harris | | | | |
| D394,964 | S | 6/1998 | Geier et al. | | | | |
| D401,785 | S * | 12/1998 | DePottay | | D6/680 | | |
| D404,224 | S * | 1/1999 | Favetta | | D6/680 | | |
| 6,119,873 | A | 9/2000 | Matthews | | | | |
| D435,182 | S | 12/2000 | Mason | | | | |
| 6,443,317 | B1 | 9/2002 | Brozak, Jr. | | | | |
| 6,585,119 | B2 | 7/2003 | Palder | | | | |
| D488,338 | S * | 4/2004 | Nelson | | D6/512 | | |
| D489,198 | S | 5/2004 | Masson | | | | |
| D493,638 | S | 8/2004 | Peyker | | | | |
| D500,417 | S * | 1/2005 | Levin | | D6/680.2 | | |
| D500,418 | S * | 1/2005 | Levin | | D6/680.2 | | |
| D504,050 | S | 4/2005 | Vidal | | | | |
| 6,915,914 | B2 | 7/2005 | Farrand | | | | |
| 7,051,899 | B1 | 5/2006 | Offenhauer | | | | |
| D538,556 | S | 3/2007 | Arias | | | | |
| D565,324 | S | 4/2008 | Sparkowski | | | | |
| D565,326 | S | 4/2008 | Warne | | | | |
| 7,523,833 | B2 | 4/2009 | Zipeto | | | | |
| D596,423 | S * | 7/2009 | Opolka | | D6/680.2 | | |
| 7,815,048 | B2 | 10/2010 | Bean | | | | |
| D629,228 | S | 12/2010 | Allman | | | | |
| D632,508 | S * | 2/2011 | Levy | | D6/680.2 | | |
| 8,079,313 | B2 | 12/2011 | Sparkowski | | | | |
| D651,454 | S | 1/2012 | Chin | | | | |
| D654,727 | S * | 2/2012 | Shea | | D6/682.2 | | |
| D657,591 | S | 4/2012 | Sanchez | | | | |
| D690,136 | S * | 9/2013 | Alimenti | | D6/672 | | |
| 8,651,299 | B2 | 2/2014 | Fromm | | | | |
| 8,887,333 | B2 | 11/2014 | Cohen | | | | |
| D727,109 | S | 4/2015 | Baussion | | | | |
| D728,963 | S | 5/2015 | Provost | | | | |
| D742,143 | S * | 11/2015 | Monlun | | D6/677.1 | | |
| D752,370 | S * | 3/2016 | Mchatet | | D6/675 | | |
| 9,332,865 | B1 | 5/2016 | Mason | | | | |
| D763,021 | S * | 8/2016 | Eddershaw | | D6/680 | | |
| 9,420,860 | B2 | 8/2016 | Jaffe | | | | |
| 10,213,031 | B2 * | 2/2019 | Cohen | | A47F 5/0018 | | |
| D853,749 | S * | 7/2019 | Kostjal | | D6/567 | | |
| 2005/0224431 | A1 | 10/2005 | Campello | | | | |
| 2005/0284825 | A1 | 12/2005 | Goldsmith | | | | |
| 2006/0169653 | A1 | 8/2006 | Palder | | | | |
| 2007/0272639 | A1 | 11/2007 | Alexander | | | | |
| 2009/0032483 | A1 | 2/2009 | Yang et al. | | | | |

* cited by examiner

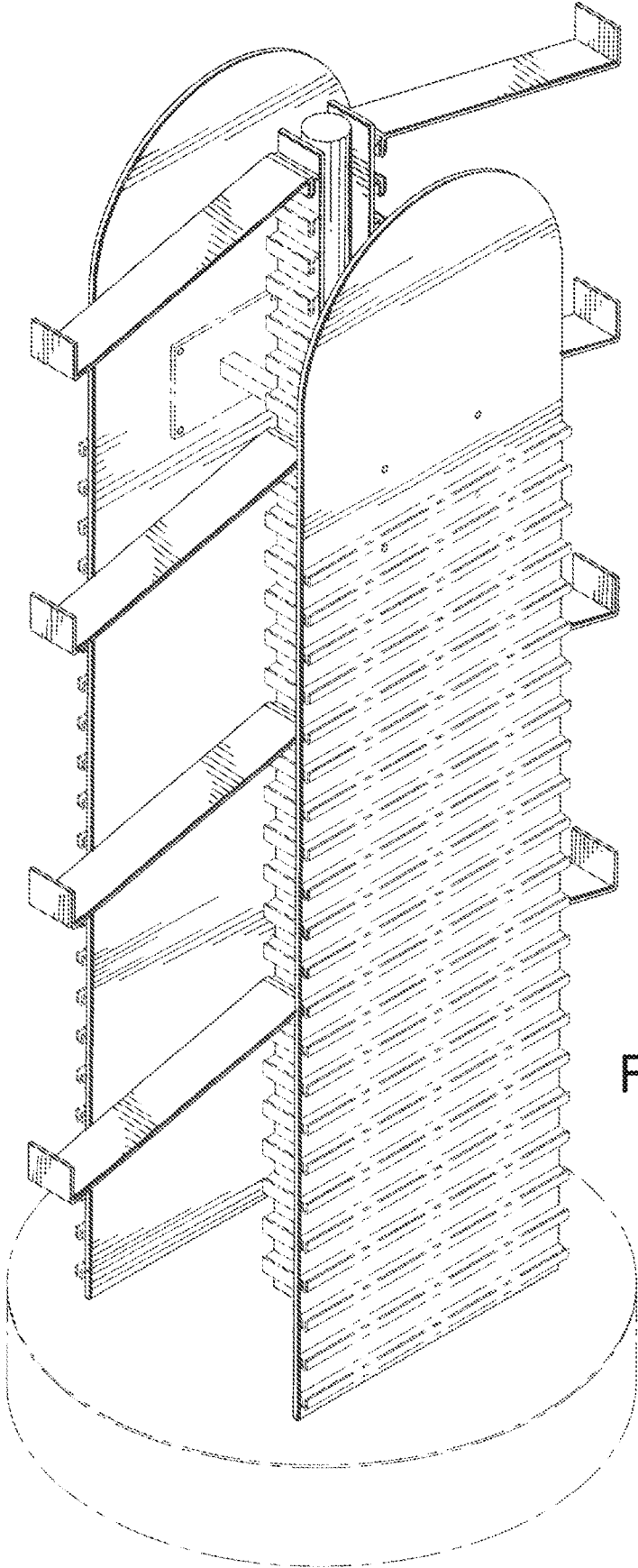

FIG. 1

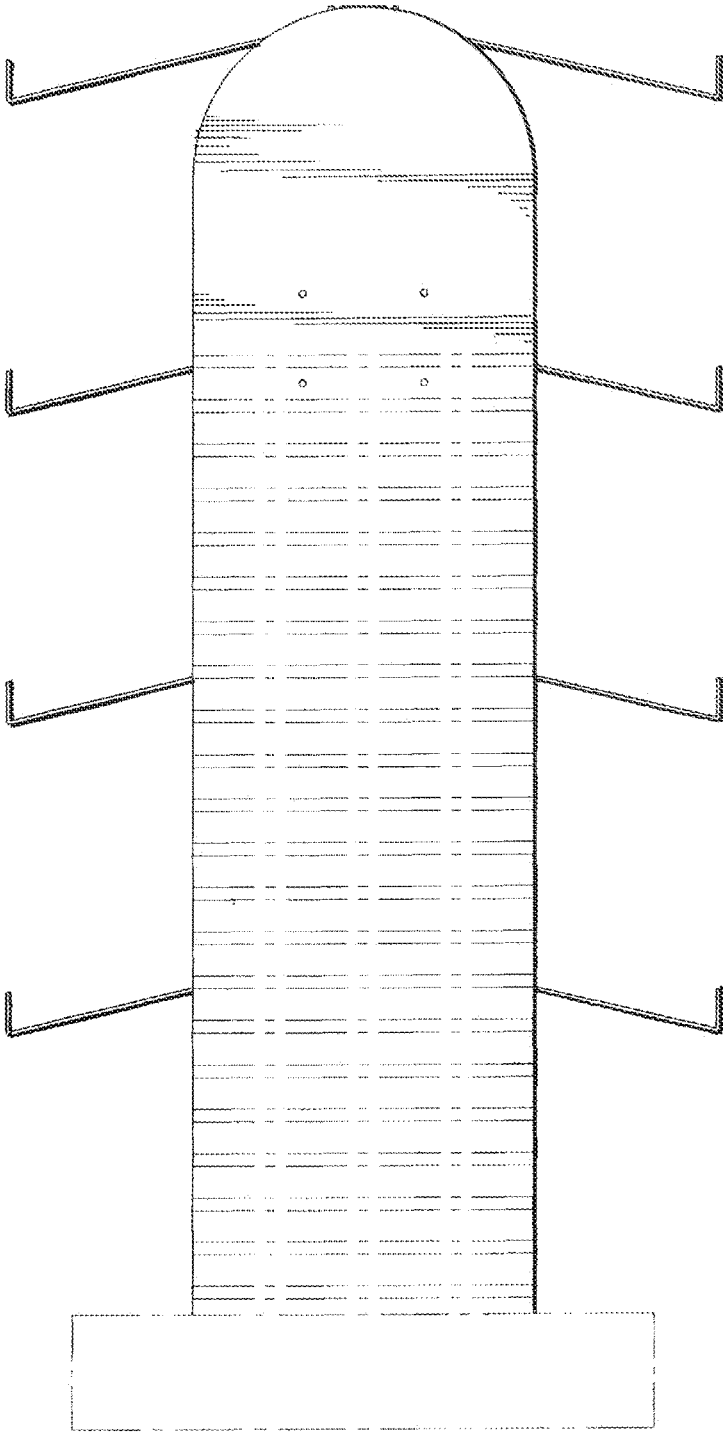

FIG. 2

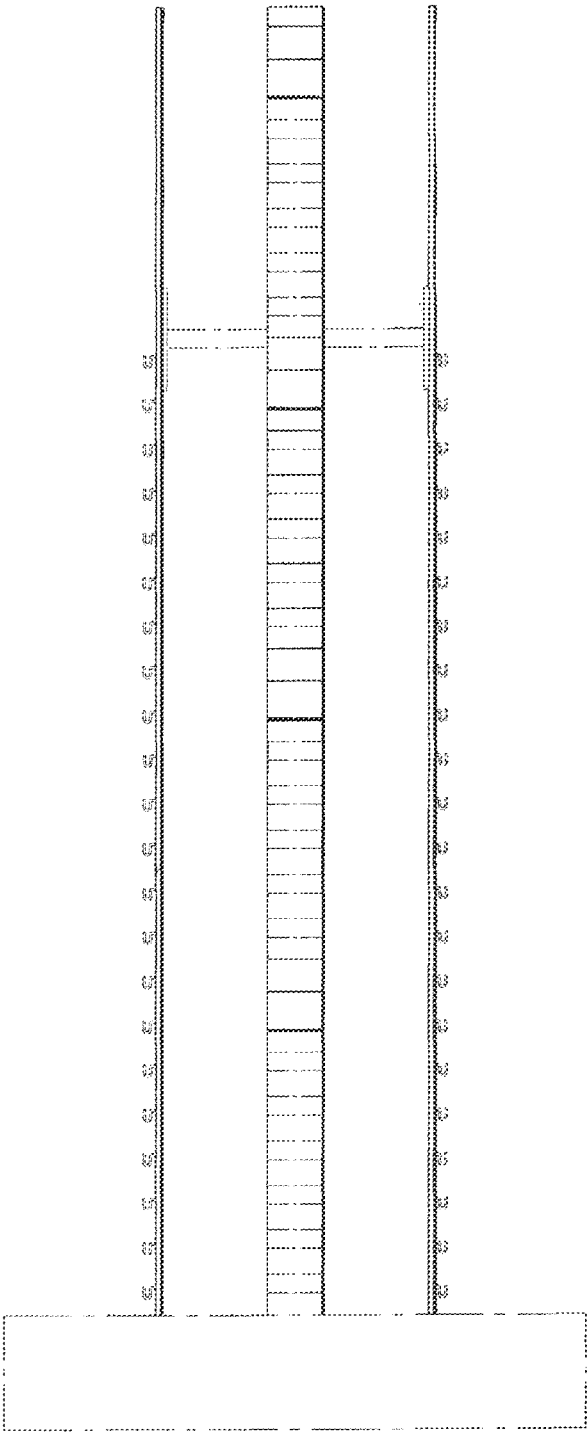

FIG. 3

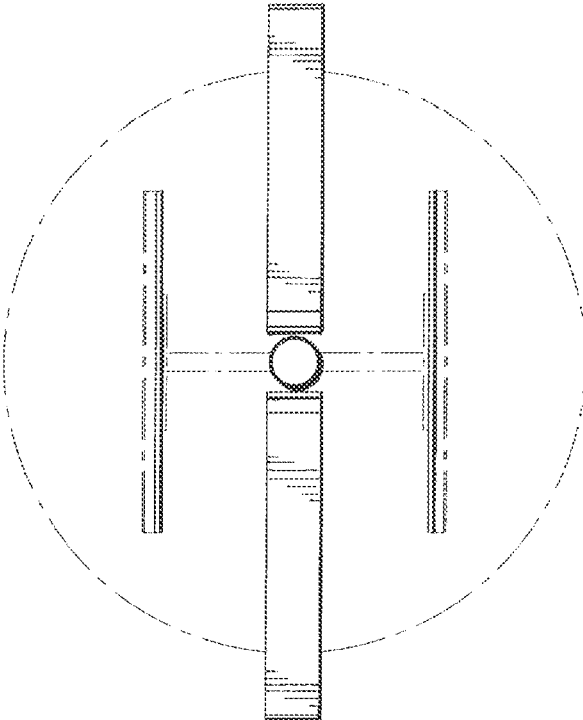

FIG. 4

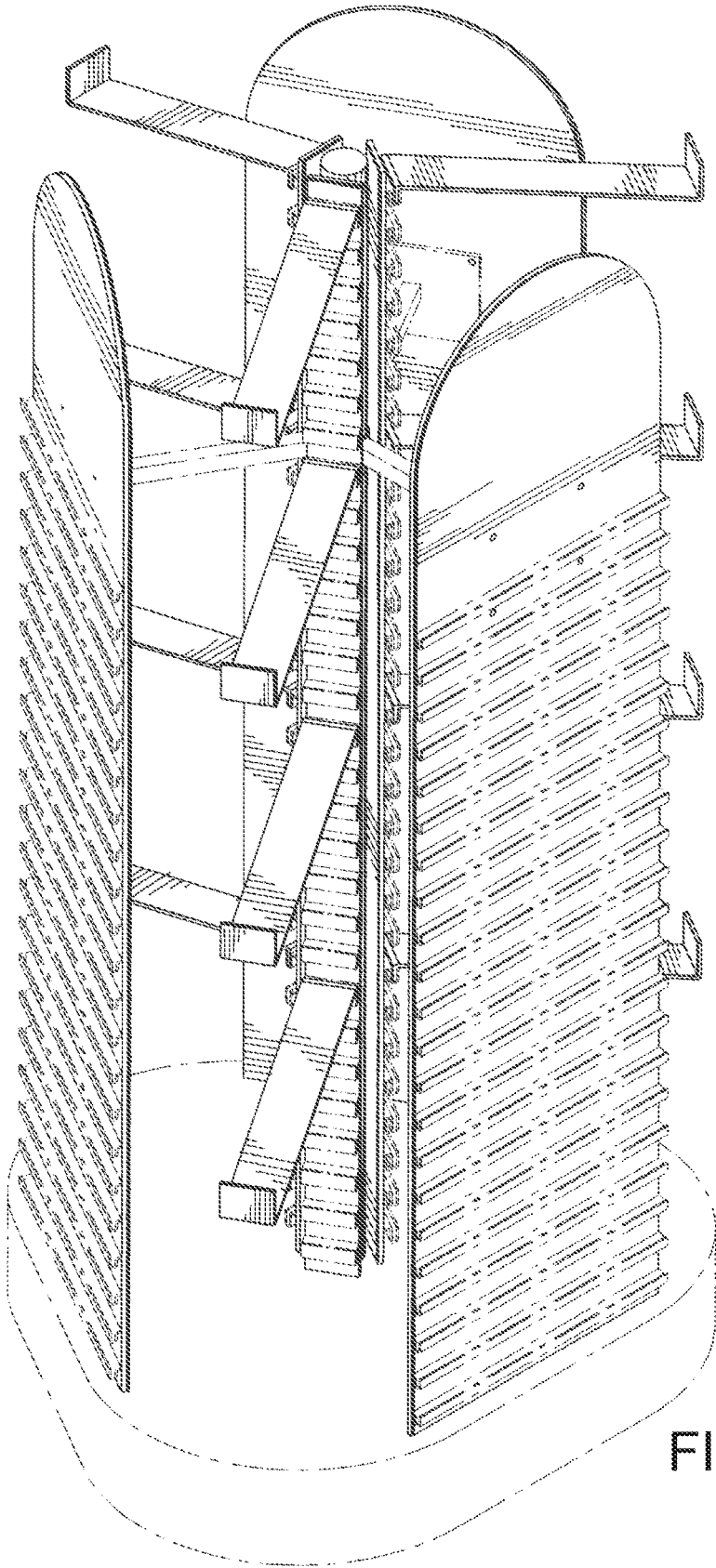

FIG. 5

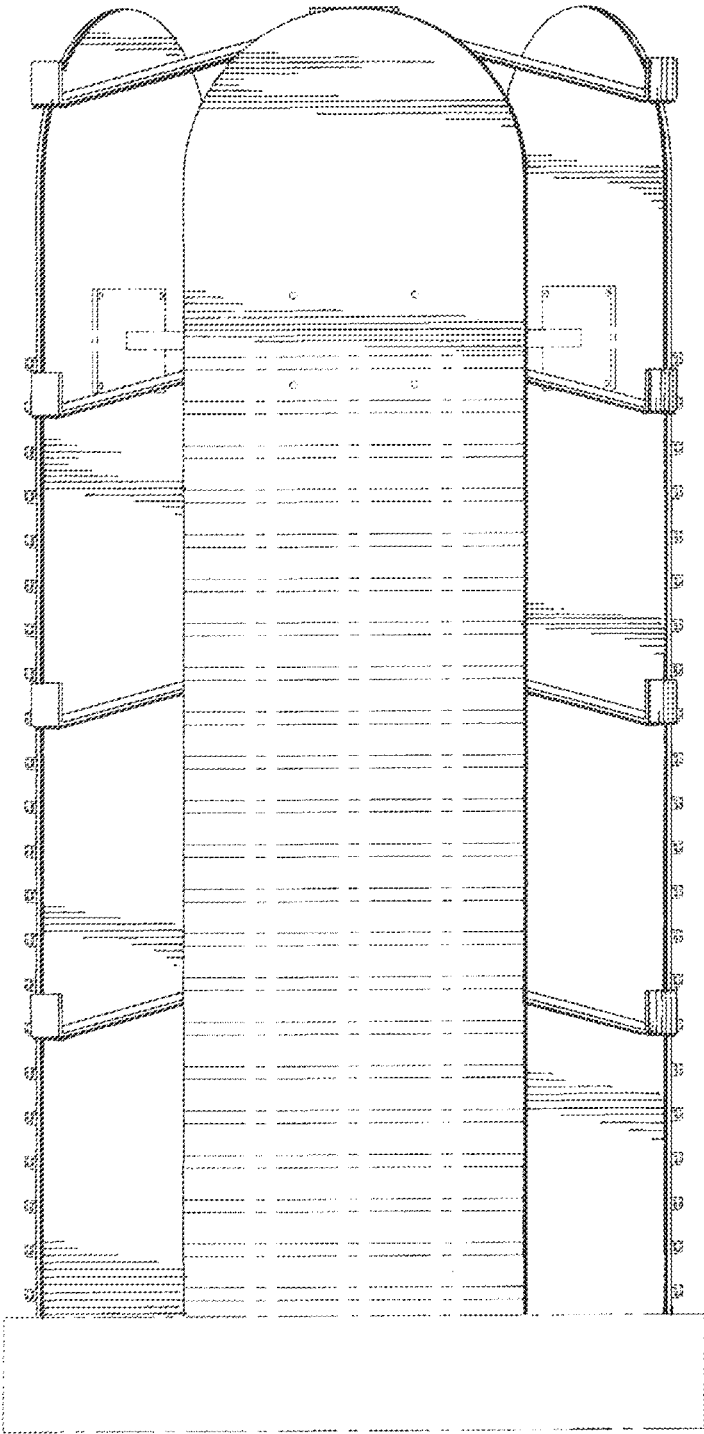

FIG. 6

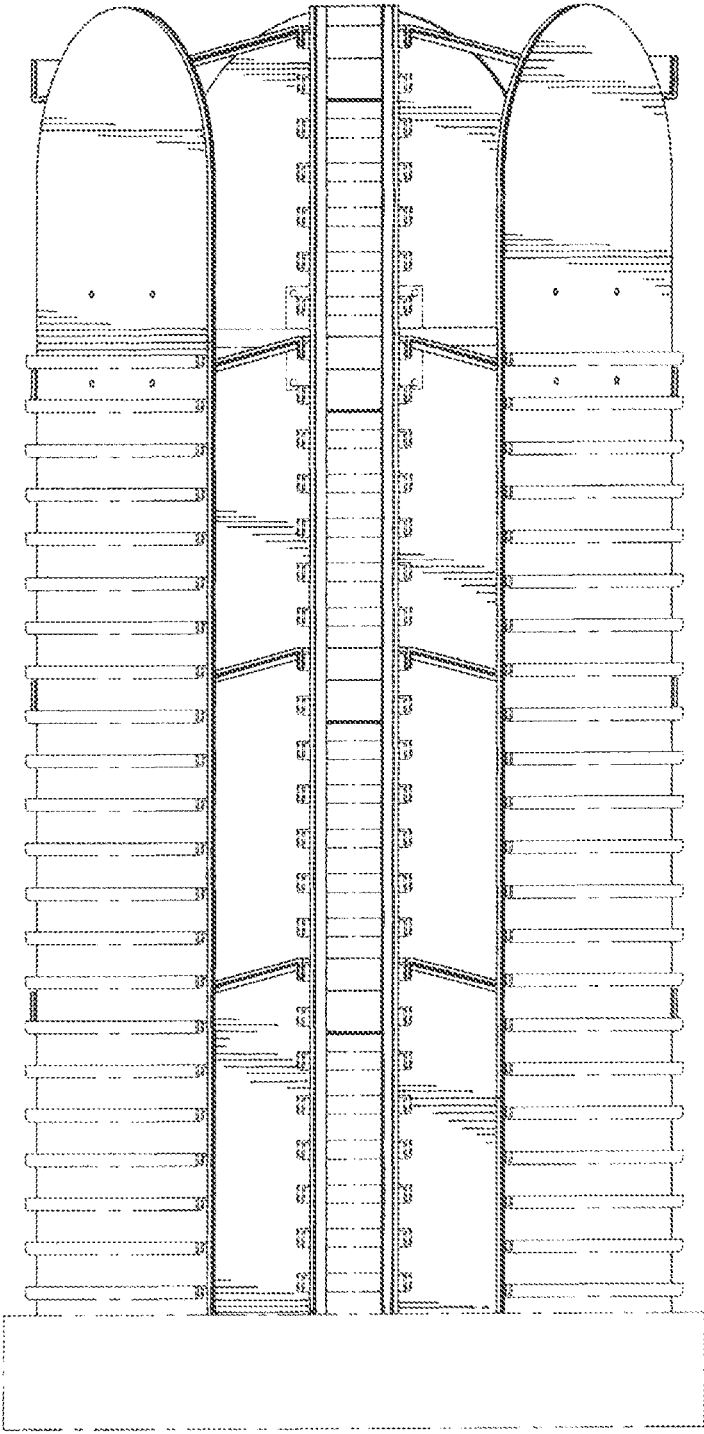

FIG. 7

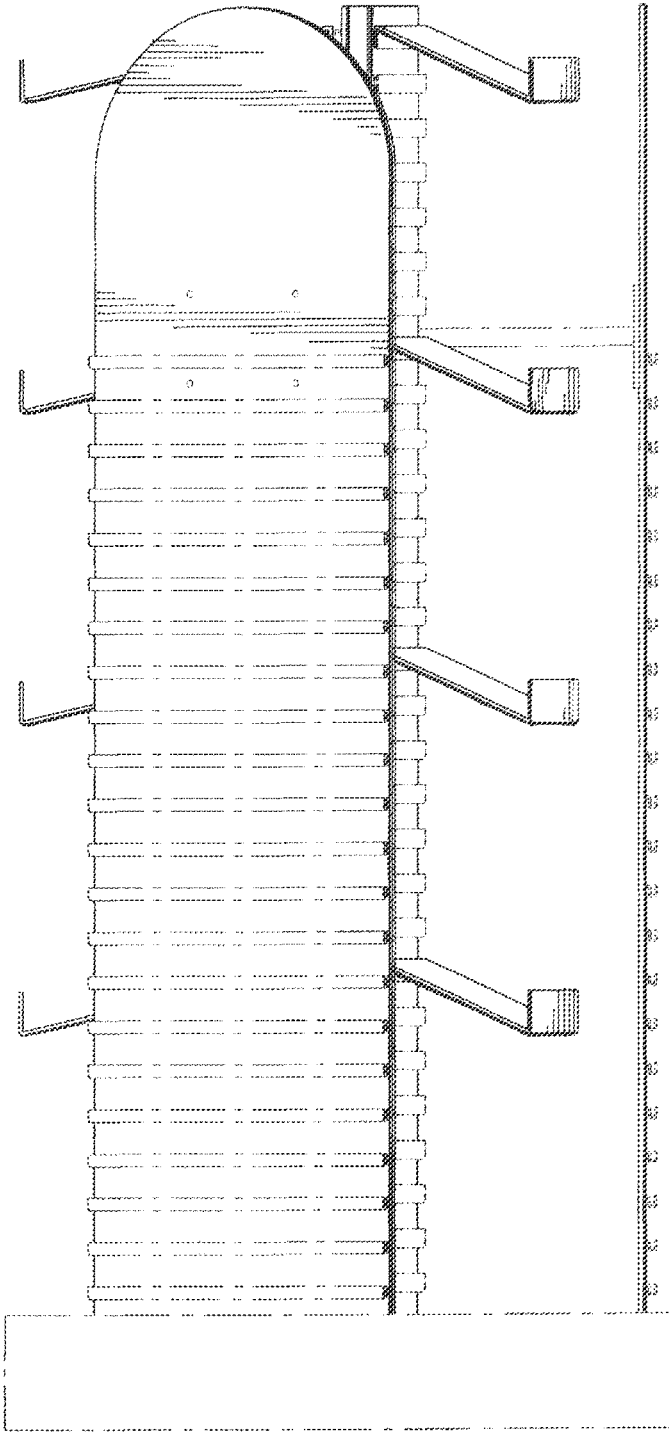

FIG. 8

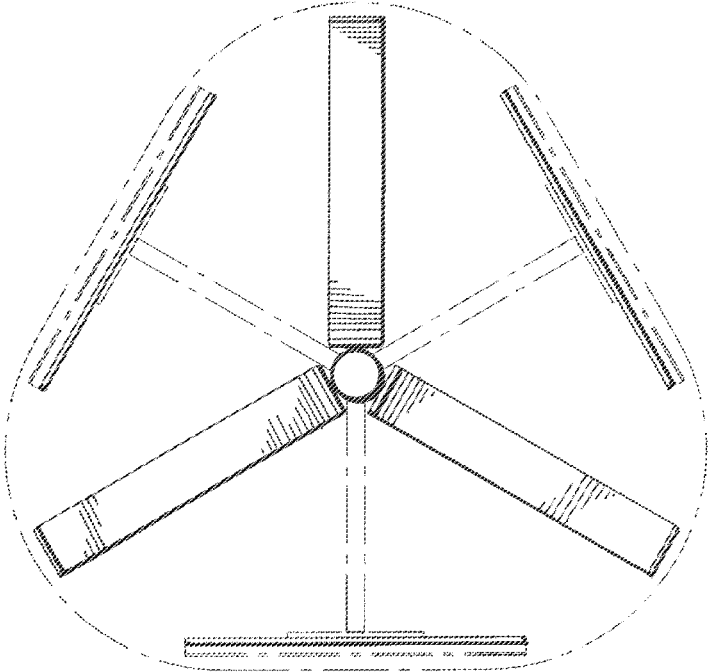

FIG. 9

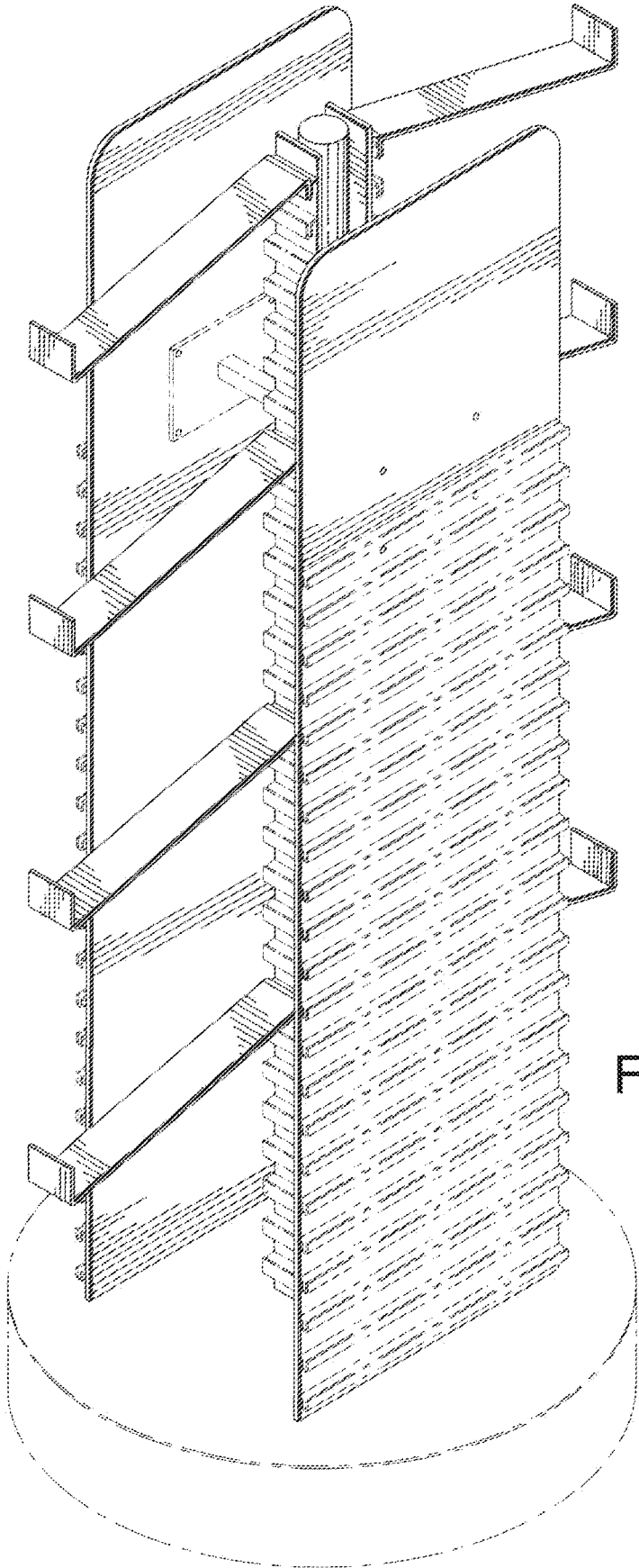

FIG. 10

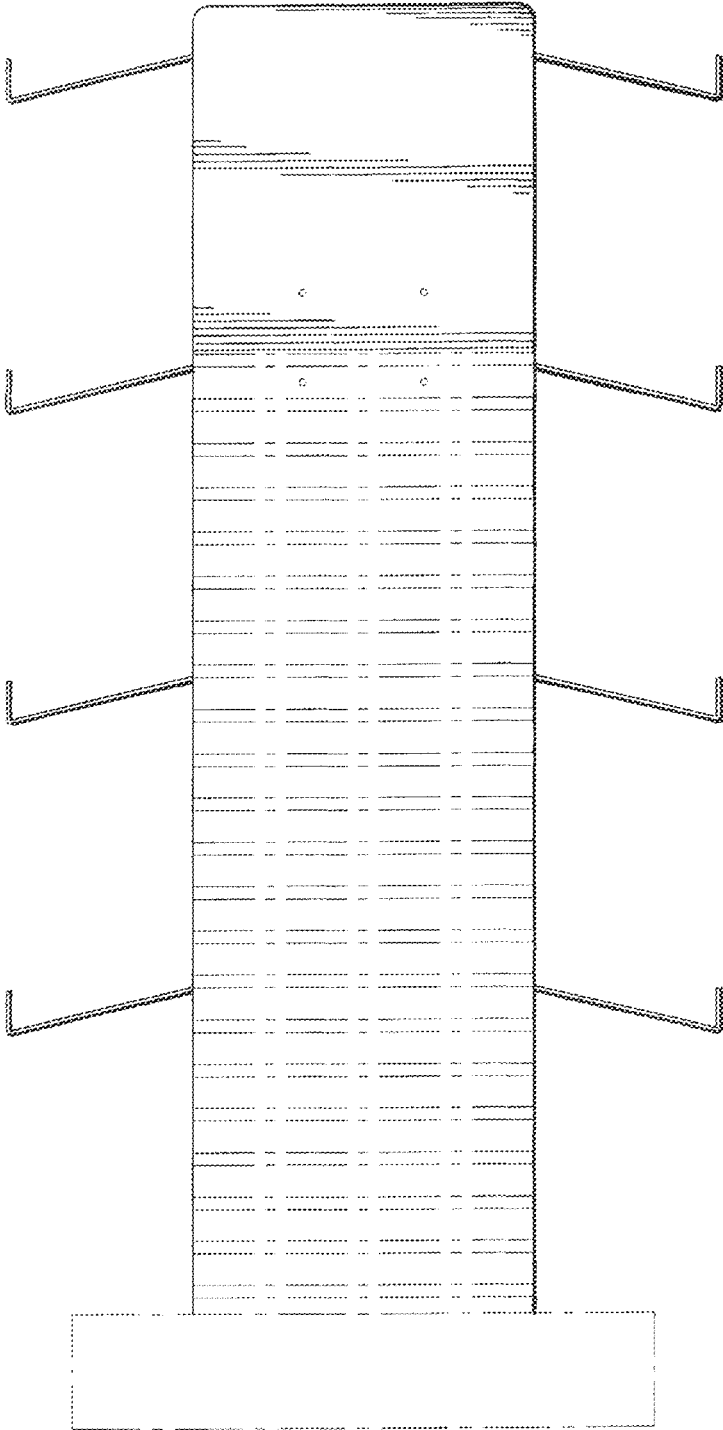

FIG. 11

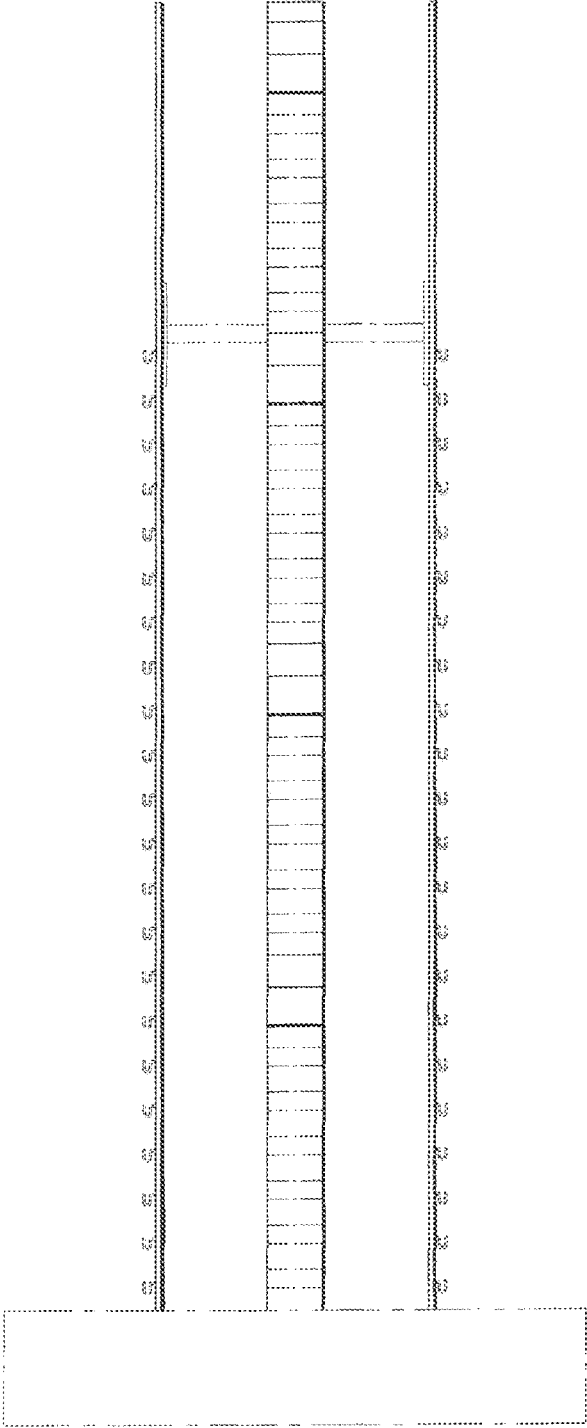

FIG. 12

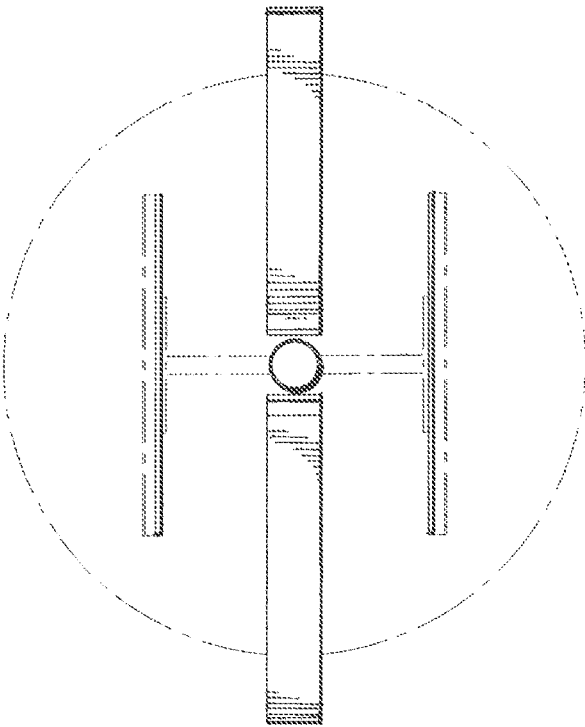

FIG. 13

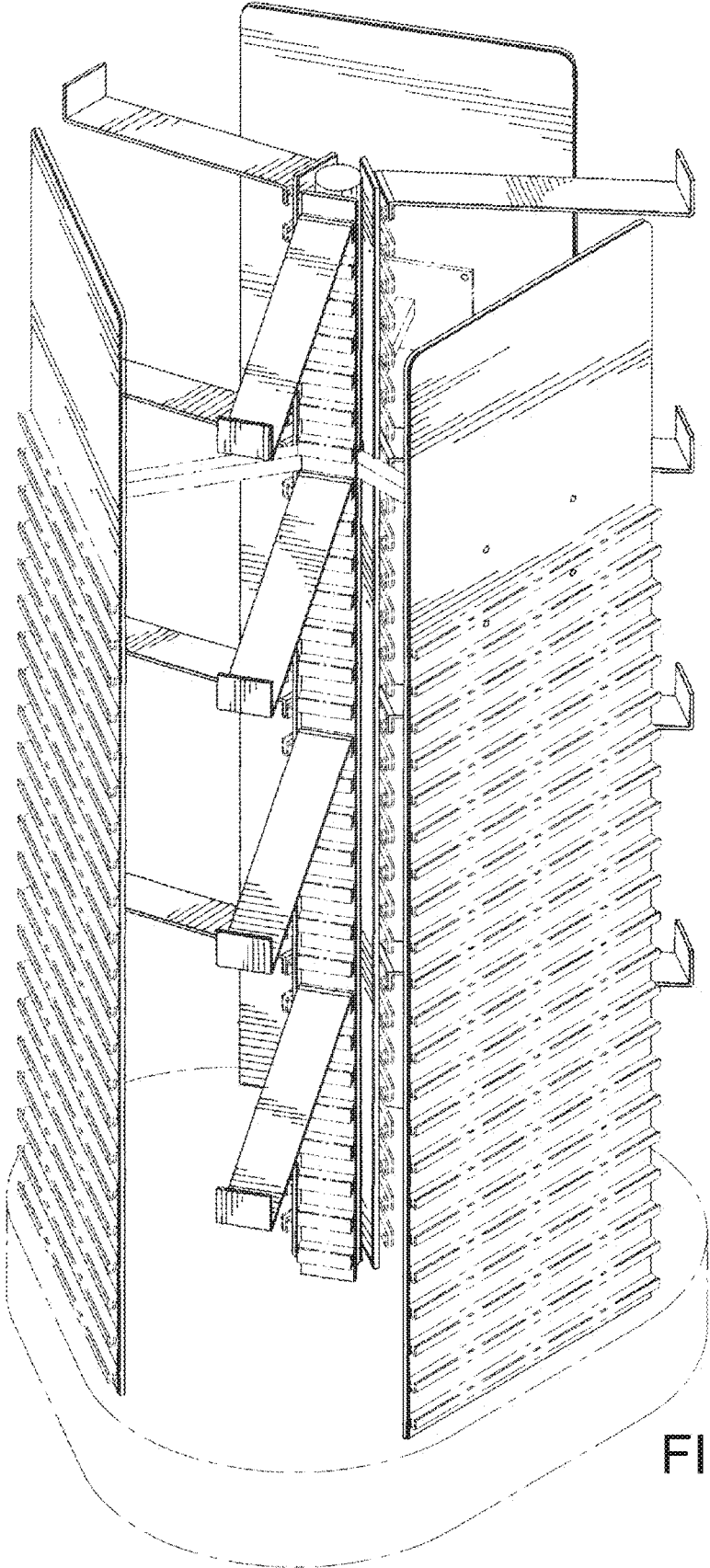

FIG. 14

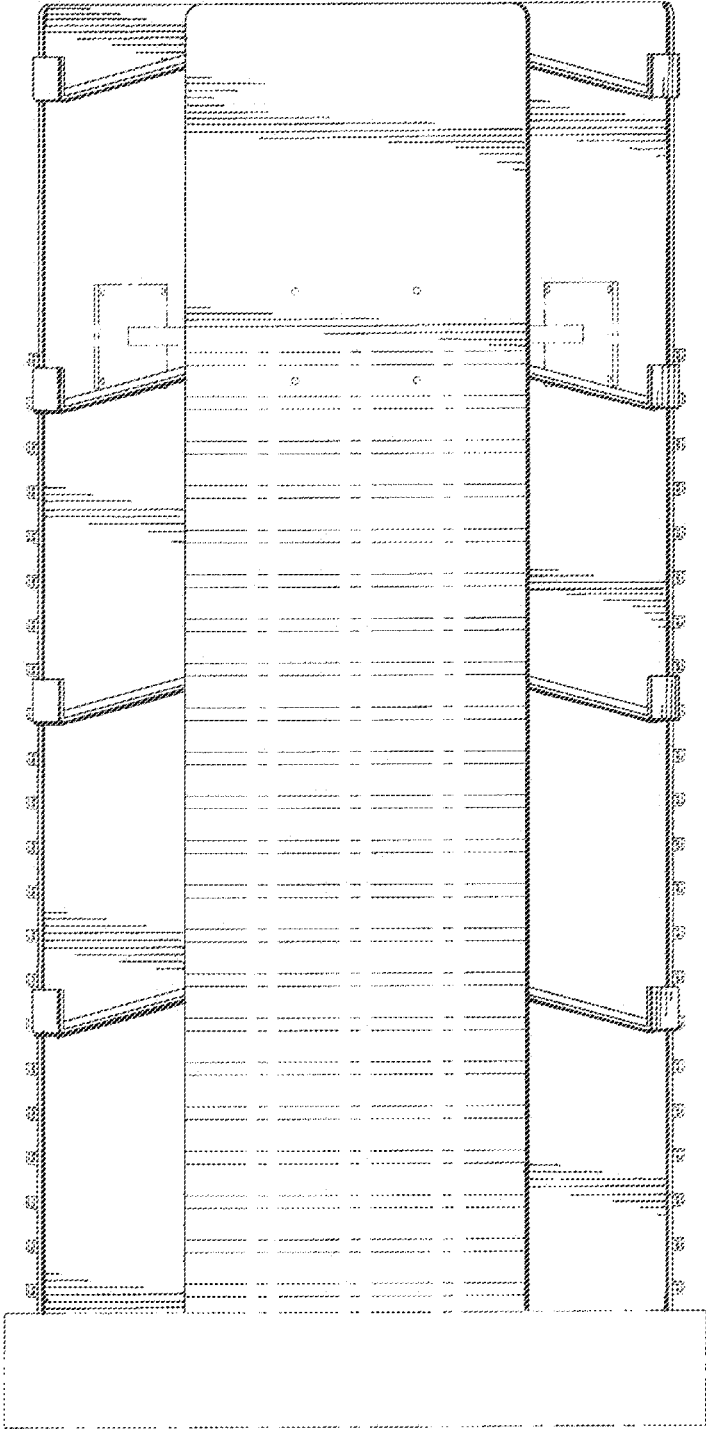

FIG. 15

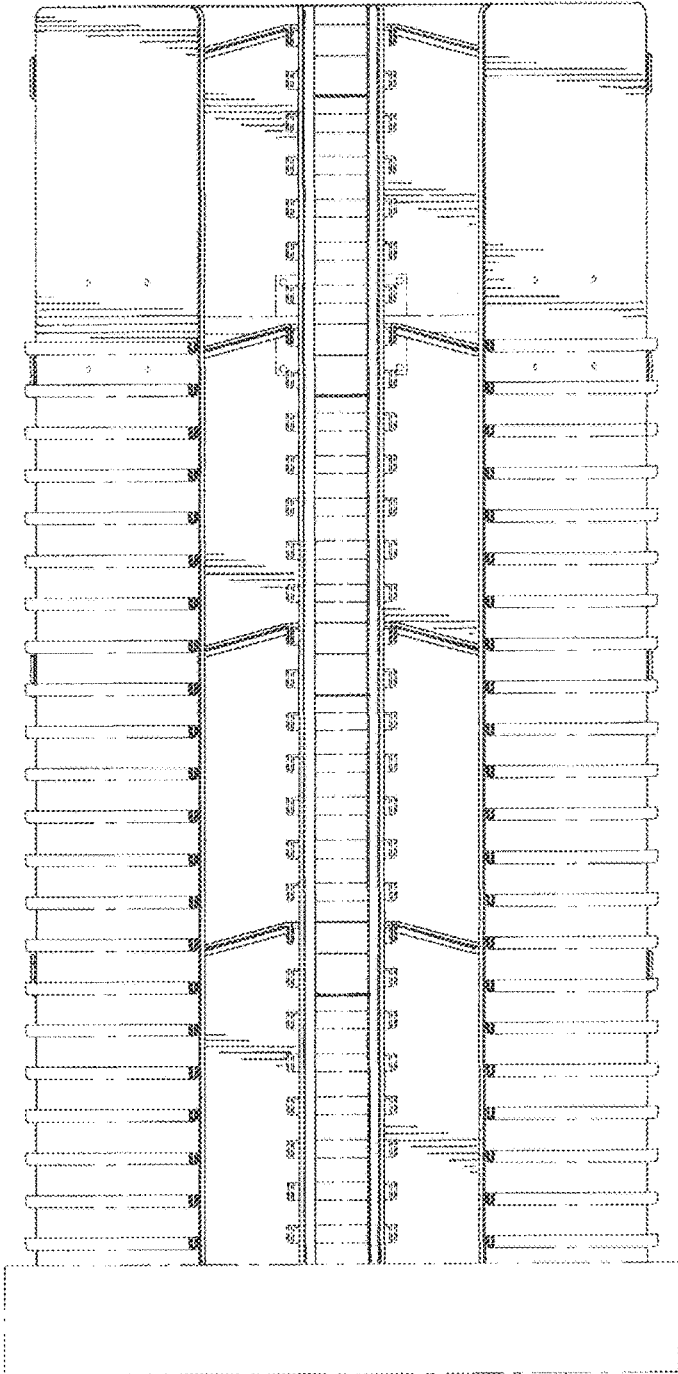

FIG. 16

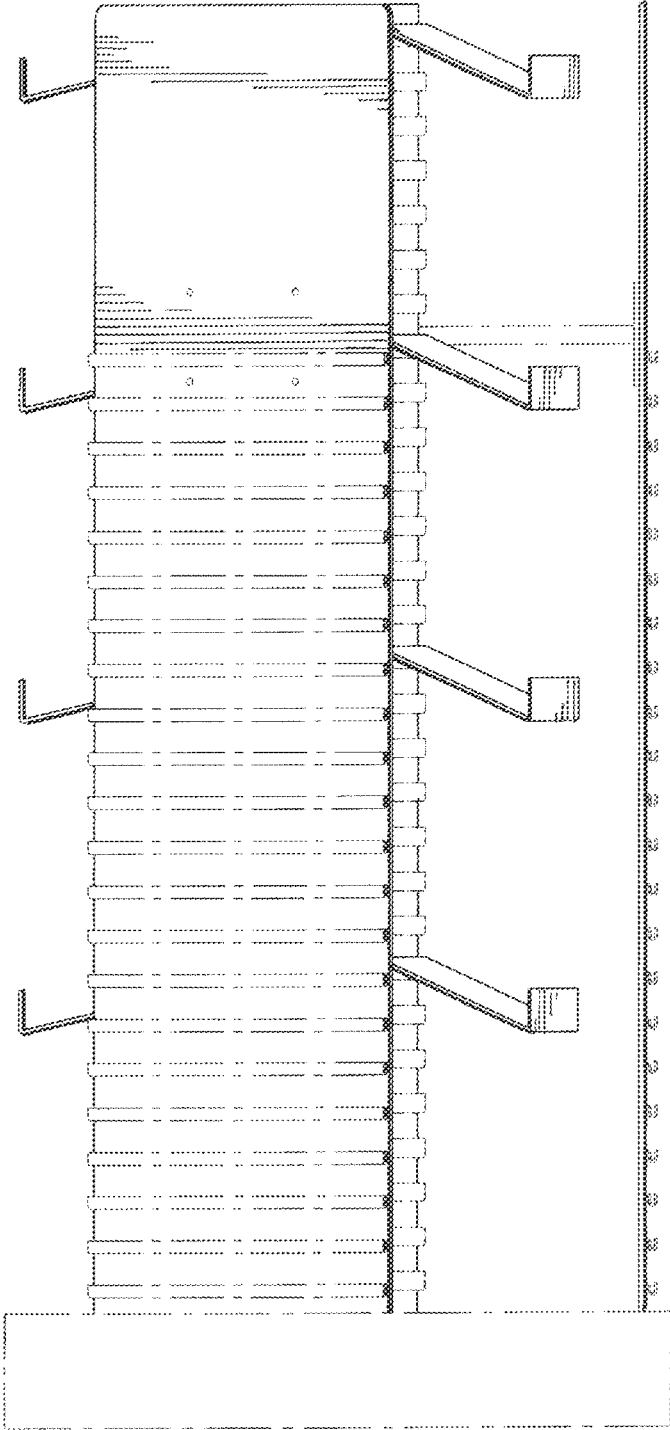

FIG. 17

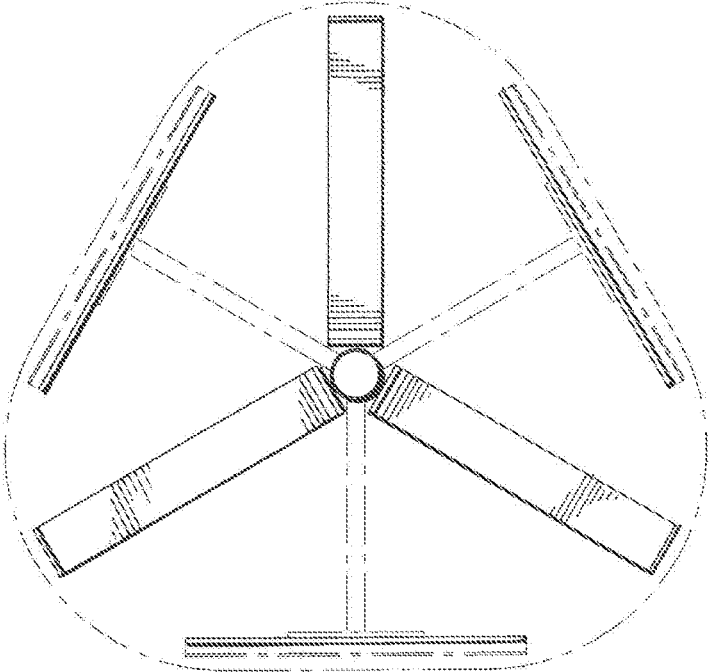

FIG. 18