



US00D922140S

(12) **United States Design Patent**
Taylor et al.

(10) **Patent No.:** **US D922,140 S**
(45) **Date of Patent:** **** Jun. 15, 2021**

- (54) **BOTTLE LID LUG**
- (71) Applicant: **Helen of Troy Limited**, St. Michael (BB)
- (72) Inventors: **Justin Taylor**, Bend, OR (US); **Ryan Diener**, Bend, OR (US); **Jarett Volkoff**, Bend, OR (US)
- (73) Assignee: **Helen of Troy Limited**, St. Michael (BB)
- (**) Term: **15 Years**
- (21) Appl. No.: **29/747,580**
- (22) Filed: **Aug. 24, 2020**

D524,909 S	7/2006	Bakke et al.
D583,626 S	12/2008	Toth et al.
D615,816 S	5/2010	Joy et al.
D622,089 S	8/2010	Daniel et al.
D630,044 S *	1/2011	Lane D7/392.1
D651,847 S	1/2012	Gilbert
D653,499 S	2/2012	Dietterle et al.
D655,796 S	3/2012	DeWitt et al.
D656,820 S	4/2012	Willows et al.
8,215,511 B1	7/2012	Lin

(Continued)

OTHER PUBLICATIONS

“Ibeet: Replacement Flip-Lid for Hydro Flask Wide-Mouth Bottle”. Found online May 4, 2021 at amazon.com. Reference dated Feb. 28, 2019. Retrieved from [https://www.amazon.com/IBEET-Replacement-Thermoflask-Insulated-Bottles/dp/B081JWJH6Z?.](https://www.amazon.com/IBEET-Replacement-Thermoflask-Insulated-Bottles/dp/B081JWJH6Z?)*

(Continued)

Related U.S. Application Data

- (62) Division of application No. 29/672,029, filed on Dec. 2, 2018, now Pat. No. Des. 895,351.
- (51) **LOC (13) Cl.** **07-01**
- (52) **U.S. Cl.** **D7/396.2**
- (58) **Field of Classification Search**
USPC D7/392, 392.1, 396.1, 396.2, 397, 509, D7/510, 533, 619.1, 622; D9/435, 443, D9/516
CPC B65D 23/108; B65D 23/106; B65D 47/2037; B65D 47/066; A47G 19/2272
See application file for complete search history.

Primary Examiner — Kendra Leslie Hamilton
(74) *Attorney, Agent, or Firm* — Rankin, Hill & Clark LLP

(57) **CLAIM**

The ornamental design for a bottle lid lug, as shown and described.

DESCRIPTION

FIG. 1 is a top, front, left perspective view of a bottle lid lug showing our new design;
FIG. 2 is a left side view thereof;
FIG. 3 is a front elevation view thereof;
FIG. 4 is a top plan view thereof;
FIG. 5 is a bottom plan view thereof; and,
FIG. 6 is a top, front, left perspective view of the bottle lid lug of FIG. 1, shown in a condition of use.
The broken lines in FIGS. 1-6 illustrate portions of a bottle lid that form no part of the claimed design. The broken lines in FIG. 6 showing a bottle illustrate environmental subject matter only and form no part of the claimed design.

(56) **References Cited**
U.S. PATENT DOCUMENTS

2,869,938 A *	1/1959	Mills	B61F 15/26 384/190.3
3,412,887 A *	11/1968	Swartwood	B65D 23/108 215/397
D277,825 S	3/1985	Whatley		
D398,193 S	9/1998	Sanchez		

1 Claim, 6 Drawing Sheets

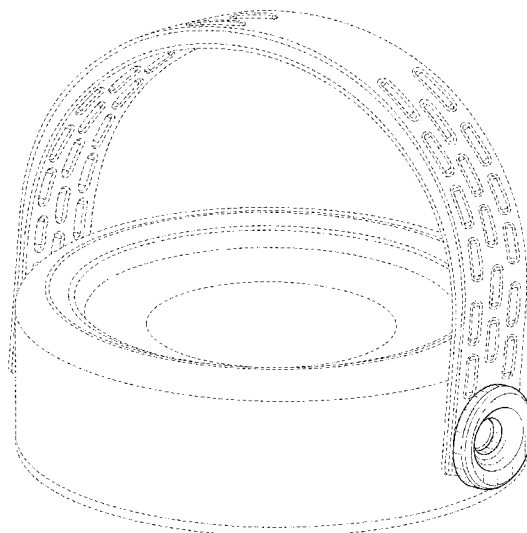

(56)

References Cited

U.S. PATENT DOCUMENTS

D668,148 S 10/2012 Sory
 D668,502 S 10/2012 Sakulsacha
 D689,735 S 9/2013 Redfern
 D690,336 S 9/2013 Gjertsen
 D690,987 S 10/2013 Gallen
 D709,995 S 7/2014 Crabbe et al.
 D721,914 S 2/2015 Hakim
 D742,230 S * 11/2015 Charles D9/449
 D755,561 S 5/2016 Eyal
 D758,859 S 6/2016 Sorensen
 D760,080 S 6/2016 Gorbold
 D781,146 S 3/2017 Seiders et al.
 D806,468 S * 1/2018 Goodwin D7/392.1
 D808,248 S 1/2018 Krombein
 9,950,556 B1 4/2018 Laemle et al.
 D818,310 S 5/2018 Cheng
 D818,360 S 5/2018 Oates, II et al.
 D820,085 S 6/2018 Moore et al.
 D833,281 S * 11/2018 Orcutt D9/455
 D837,685 S 1/2019 Miki
 D841,398 S 2/2019 Gauss et al.
 D849,482 S 5/2019 Diener et al.
 D852,041 S 6/2019 Aviles
 D853,236 S 7/2019 Yao
 D853,238 S 7/2019 Yao
 D857,456 S 8/2019 Bell et al.
 D862,977 S * 10/2019 Bohman D7/392
 D867,880 S 11/2019 Sacchetti
 D872,524 S 1/2020 Bo
 D880,954 S 4/2020 McCutchen
 D885,837 S 6/2020 Bo
 D887,776 S 6/2020 Bo
 D894,672 S * 9/2020 Huang D7/392.1
 D895,351 S * 9/2020 Taylor D7/392.1
 D896,574 S * 9/2020 Wang D7/392.1

D900,538 S * 11/2020 Yao D7/392.1
 D911,771 S * 3/2021 Zhang D7/392.1
 2014/0069917 A1 3/2014 Meyers et al.
 2015/0336720 A1 11/2015 Gorbold
 2016/0318693 A1 11/2016 Hein et al.
 2016/0324350 A1 11/2016 Rogers et al.
 2019/0135506 A1* 5/2019 Merrigan B65D 41/04

OTHER PUBLICATIONS

“Loopilops: 15 mm Rubber Button”. Found online Nov. 22, 2016 at amazon.com. Reference dated Aug. 25, 2014. Retrieved from https://www.amazon.com/Rubber-Button-Repair-Replacement-Cross/dp/B00N18BOOE/ref=cm_cr_ar_p_d_product_top?ie=UTF8.
 “Avex: Freestyle Kids Autospout Water Bottle”. Found online Oct. 24, 2017 at amazon.com. Reference dated Jul. 15, 2014. Retrieved from https://www.amazon.com/Freestyle-Autospout-Bottle-Orange-Superhero/dp/B00X0YTDCO/ref=sr_1_4?ie=UTF8&qid=1508879300&sr=8-4&keywords=avex.
 “Hydro Flask Water Bottle, Wide Mouth with Free Flex Cap”, Found online Jun. 7, 2017 at amazon.com. Page dated May 10, 2016. Retrieved from https://www.amazon.com/KOLD-Sports-Water-Bottles-Insulated-Stainless/dp/B01ACAX702/ref=cm_cr_ar_p_d_product_top?ie=UTF8.
 “KOLD Sports Water Bottle, Wide Mouth, with Caribiner Handle Lid”. Found online Feb. 7, 2020 at amazon.com. Page dated Nov. 17, 2009. Retrieved from https://www.amazon.com/Klean-Kanteen-Stainless-D-Ring-Bottle/dp/B0093IKZGY/ref=cm_cr_ar_p_d_product_top?ie=UTF8.
 “Klean Kanteen Pint Lid.” Found online Feb. 7, 2020 at amazon.com. Page dated Nov. 17, 2009. Retrieved from https://www.amazon.com/Klean-Kanteen-Stainless-D-Ring-Bottle/dp/B0093IKZGY/ref=cm_cr_ar_p_d_product_top?ie=UTF8.

* cited by examiner

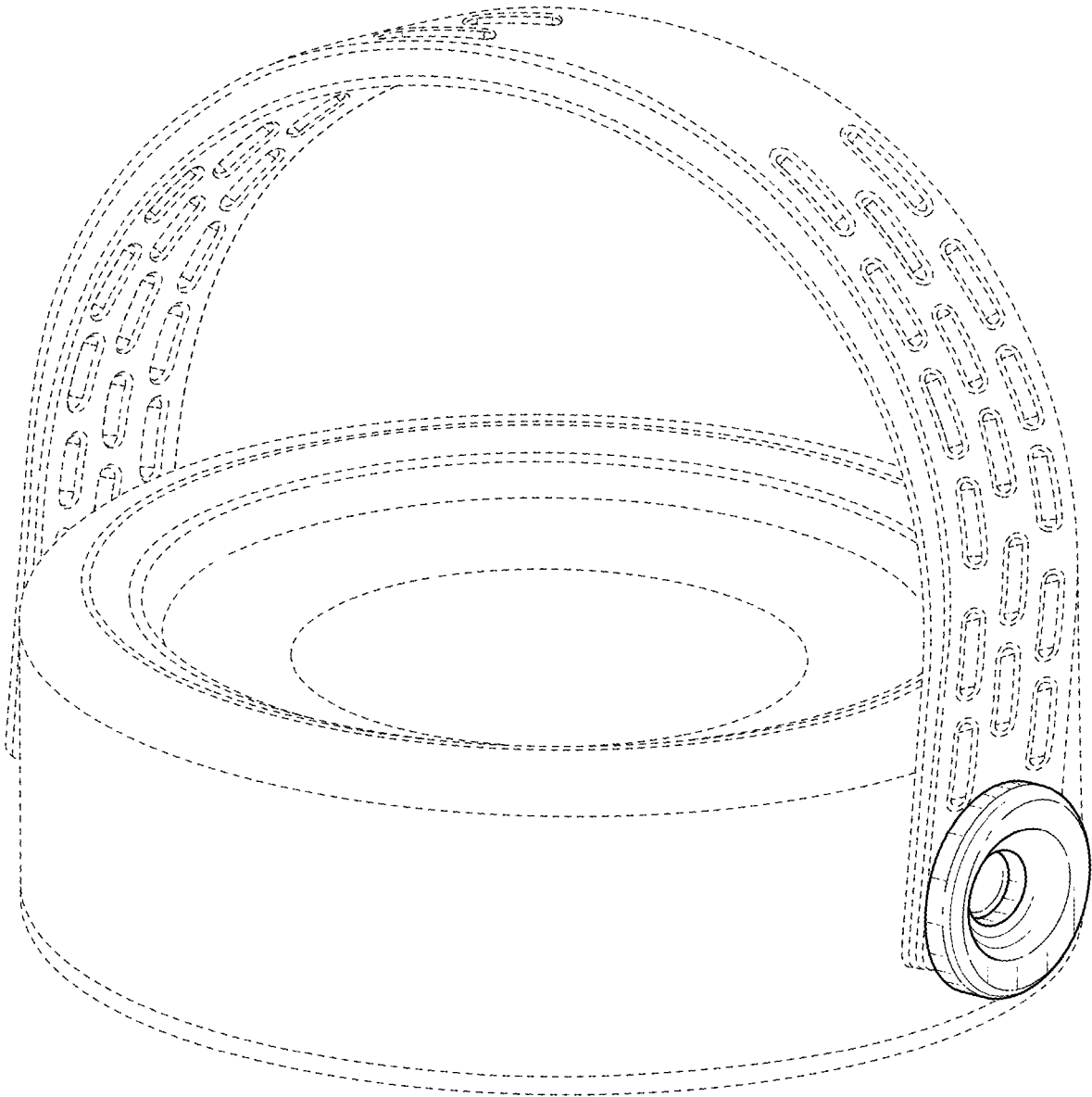

FIG. 1

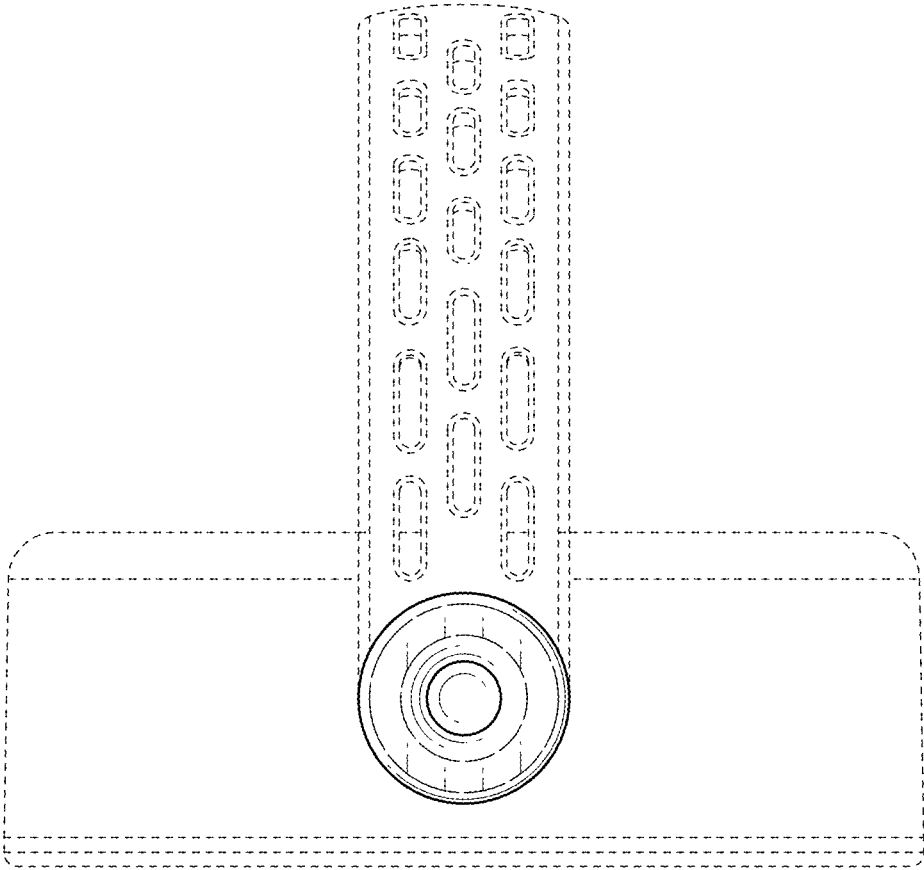

FIG. 2

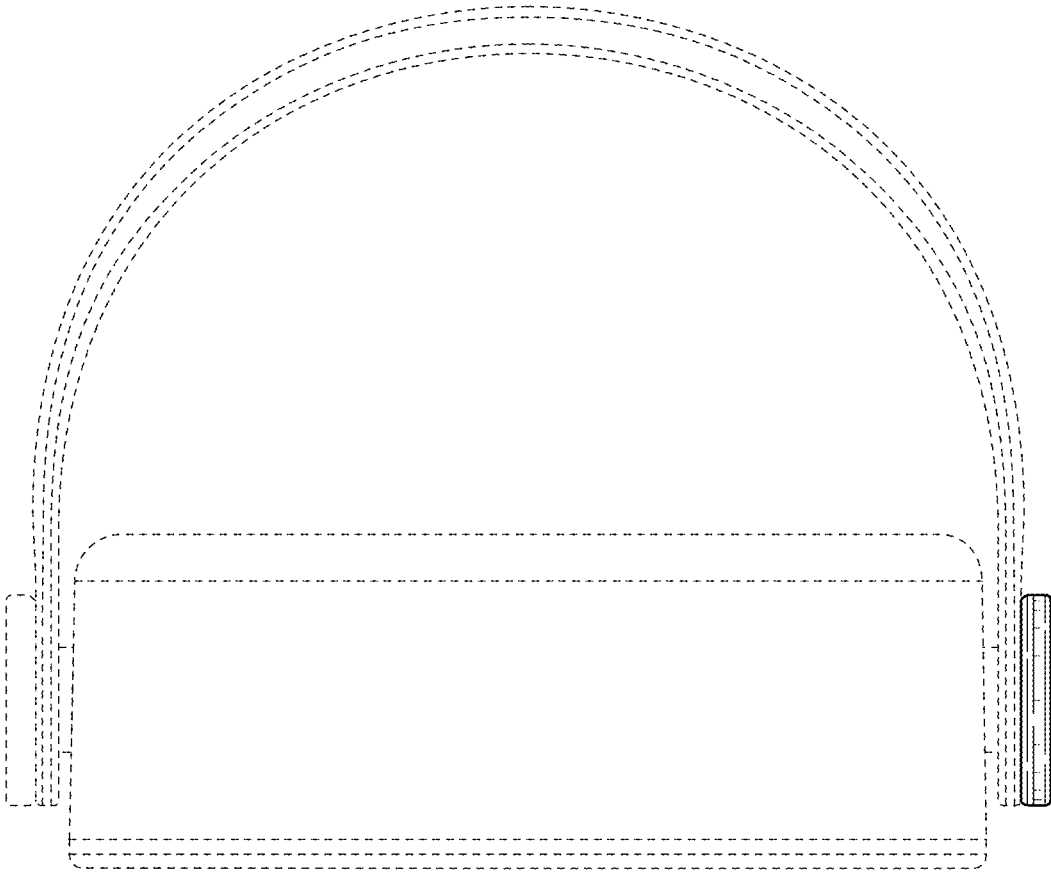

FIG. 3

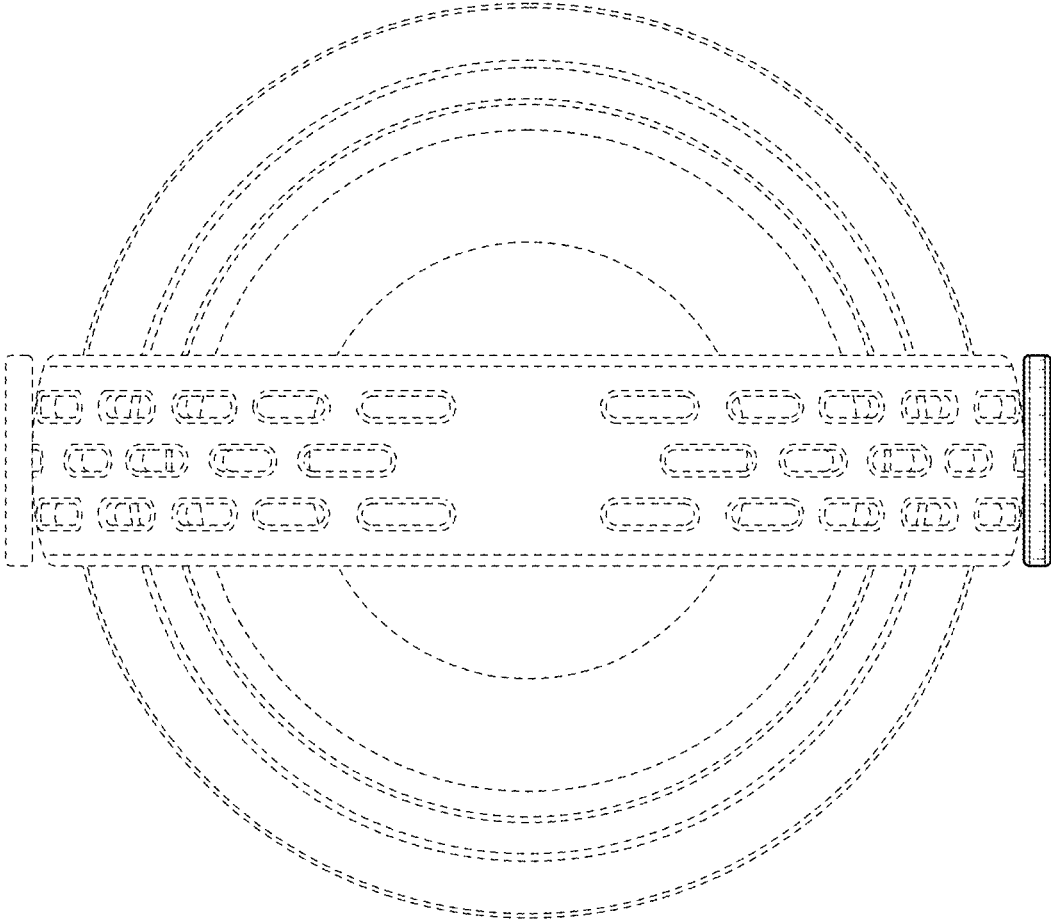

FIG. 4

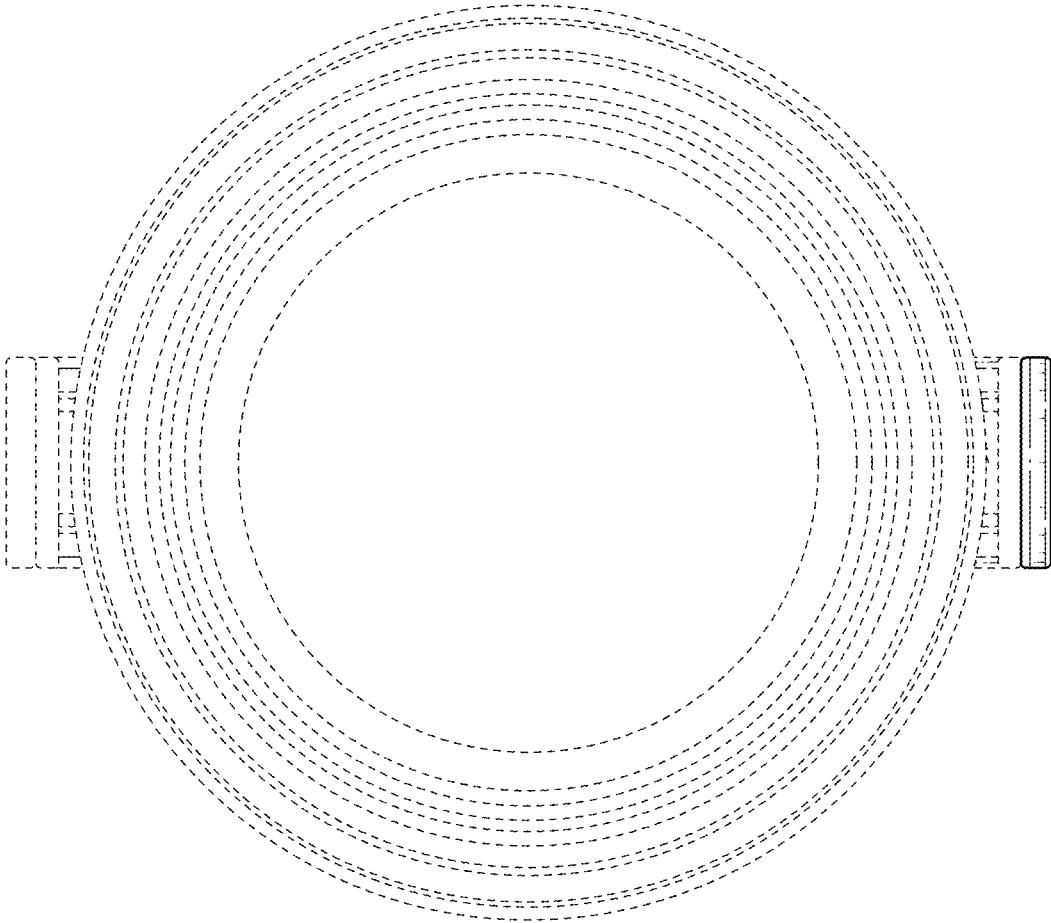

FIG. 5

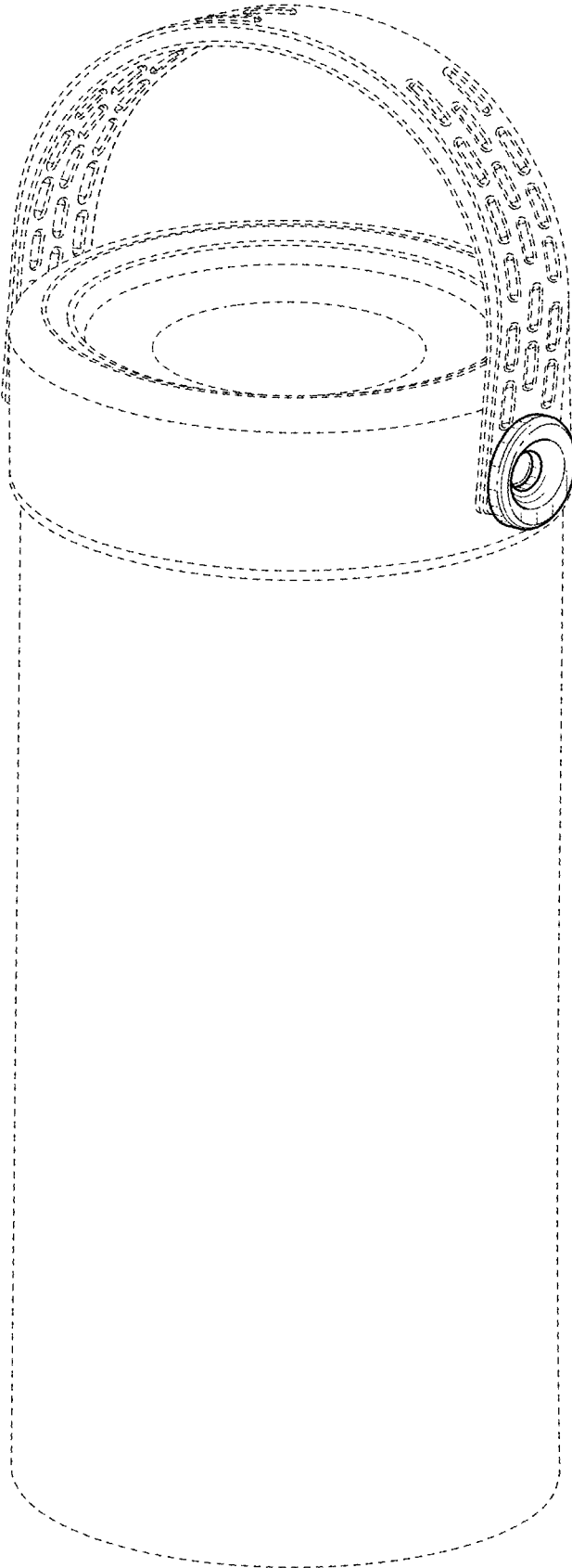

FIG. 6