



US00D883751S

(12) **United States Design Patent** (10) **Patent No.:** **US D883,751 S**
Omura et al. (45) **Date of Patent:** **** May 12, 2020**

(54) **CONTAINER**

(71) Applicant: **Nisshin Foods Inc.**, Tokyo (JP)

(72) Inventors: **Masato Omura**, Tokyo (JP); **Shuhei Yamazaki**, Tokyo (JP); **Michihiro Sakakibara**, Tokyo (JP)

(73) Assignee: **NISSHIN FOODS INC.**, Chiyoda-Ku, Tokyo (JP)

(**) Term: **15 Years**

(21) Appl. No.: **29/608,535**

(22) Filed: **Jun. 22, 2017**

(30) **Foreign Application Priority Data**

Dec. 22, 2016 (JP) 2016-027941
Dec. 22, 2016 (JP) 2016-027942

(51) **LOC (12) Cl.** **07-01**

(52) **U.S. Cl.** **D7/591**
USPC **D7/591**

(58) **Field of Classification Search**
USPC D7/602, 605-609, 619.1, 629-630;
D9/449, 500-501, 503-504, 529-530,
(Continued)

(56) **References Cited**

U.S. PATENT DOCUMENTS

D278,602 S * 4/1985 Rosenstein D9/449
4,693,399 A * 9/1987 Hickman B65D 47/0847
215/235

(Continued)

FOREIGN PATENT DOCUMENTS

EM 003844125-0001 * 5/2017
EM 003844125-0002 * 5/2017

(Continued)

OTHER PUBLICATIONS

Instant Coffee Container, Folgers, cleverlyinspired.com, posted by blogger Tracie on May 31, 2016 per wayback machine © 2019

Cleverly Inspired, online, site visited Jun. 26, 2019. Available from Internet, URL: <https://cleverlyinspired.com/2016/05/low-cal-coffee-shake-recipe-teacher-appreciation/> (Year: 2016).*

(Continued)

Primary Examiner — Marissa J Cash
Assistant Examiner — Altaira J Swangin

(74) *Attorney, Agent, or Firm* — Muncy, Geissler, Olds & Lowe, P.C.

(57) **CLAIM**

The ornamental design for a container, as shown and described.

DESCRIPTION

FIG. 1 is a top front right perspective view of a container showing our new design,
FIG. 2 is a front elevational view thereof,
FIG. 3 is a rear elevational view thereof,
FIG. 4 is a top plan view thereof,
FIG. 5 is a bottom plan view thereof,
FIG. 6 is a left side view thereof,
FIG. 7 is a right side view thereof,
FIG. 8 is a front elevational view of the container of FIGS. 1-7 in a second alternate configuration with a larger lid member open,
FIG. 9 is a top plan view thereof, with the larger lid member open,
FIG. 10 is a right side view thereof, with the larger lid member open,
FIG. 11 is a front elevational view of the container of FIGS. 1-7 in a third alternate configuration, with a smaller lid member open,
FIG. 12 is a top plan view thereof, with the smaller lid member open,
FIG. 13 is a left side view thereof, with the smaller lid member open,
FIG. 14 is a cross-sectional view taken along line 14-14 of FIG. 2; and,
FIG. 15 is a cross-sectional view taken along line 15-15 of FIG. 4.

1 Claim, 8 Drawing Sheets

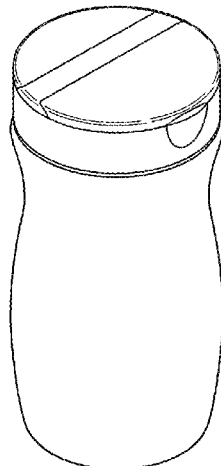

(58) **Field of Classification Search**

USPC D9/763, 772, 776; 206/139-140,
206/216-217, 528-529, 533, 540
CPC B65D 7/04; A47J 31/005; A47J 31/46
See application file for complete search history.

(56) **References Cited**

U.S. PATENT DOCUMENTS

D305,206 S * 12/1989 Hickman D9/449
4,898,292 A * 2/1990 VerWeyst B65D 47/0847
215/237
4,936,494 A * 6/1990 Weidman B65D 47/0847
215/235
4,955,513 A * 9/1990 Bennett B65D 47/0847
215/235
5,048,730 A * 9/1991 Forsyth B65D 47/0847
215/235
5,219,100 A * 6/1993 Beck B65D 47/0876
215/235
D340,187 S * 10/1993 Forsyth D9/449
5,330,082 A * 7/1994 Forsyth B65D 47/0847
222/480
D408,689 S * 4/1999 Kato D7/511
5,971,231 A * 10/1999 Samz B65D 21/0219
222/480
D445,337 S * 7/2001 Croft D9/450
D447,693 S * 9/2001 Warner D9/450
RE37,634 E * 4/2002 Hickman B65D 47/0847
215/235
6,460,718 B1 * 10/2002 Vogel B65D 21/0219
206/508
6,464,113 B1 * 10/2002 Vogel B65D 21/0219
222/480
6,575,323 B1 * 6/2003 Martin B65D 47/0852
220/254.2
D480,267 S * 10/2003 Freed D7/510
D525,129 S * 7/2006 Hutter D9/502
D532,691 S * 11/2006 Vogel D9/435
D533,064 S * 12/2006 Glynn D9/500
D582,273 S * 12/2008 Vogel D9/449
D584,107 S * 1/2009 George D7/510
7,501,933 B2 * 3/2009 Rousso A47G 19/2227
206/217
D603,702 S * 11/2009 Daggett D9/449
D603,703 S * 11/2009 Daggett B65D 43/161
D9/449
7,931,464 B2 * 4/2011 Thierjung B29C 49/62
425/525
8,141,741 B2 * 3/2012 Metzger B65D 7/04
220/672
D658,007 S * 4/2012 George D7/509

D668,509 S * 10/2012 Beugelsdijk D7/400
8,365,941 B2 * 2/2013 Mayer A45F 3/18
206/217
D690,161 S * 9/2013 Garner D7/510
D717,608 S * 11/2014 Lin D7/608
D717,609 S * 11/2014 Lin D7/608
D717,610 S * 11/2014 Lin D7/608
D768,494 S * 10/2016 Li D9/504
9,801,492 B1 * 10/2017 Lin A47J 31/20
D809,387 S * 2/2018 Tran D9/449
D809,388 S * 2/2018 Tran D9/449
D828,755 S * 9/2018 Jacobs D9/449
D850,912 S * 6/2019 Wilson D9/449
D851,456 S * 6/2019 Shen D7/510
D859,155 S * 9/2019 Reiley D9/449
10,478,007 B2 * 11/2019 He A47J 31/30
2003/0111495 A1 * 6/2003 Parve B65D 47/0847
222/556
2004/0089678 A1 * 5/2004 Martin B65D 47/0852
222/556
2004/0118846 A1 * 6/2004 Merolla B65D 47/08
220/254.2
2005/0029154 A1 * 2/2005 Kahn A61J 7/0076
206/540
2007/0145082 A1 * 6/2007 Parve B65D 47/0857
222/480
2008/0257918 A1 * 10/2008 Vogel B65D 47/0895
222/480
2011/0215116 A1 * 9/2011 Fuller A47G 19/24
222/226
2016/0360917 A1 * 12/2016 Richardson A47J 31/0576
2018/0168385 A1 * 6/2018 Boone A47J 31/52
2018/0263403 A1 * 9/2018 Richardson A47J 31/057
2019/0106253 A1 * 4/2019 Ludewig B65D 51/18
2019/0373927 A1 * 12/2019 Ohmura A23P 20/12

FOREIGN PATENT DOCUMENTS

EM 003844125-0003 * 5/2017
EM 004035343-0001 * 6/2017
EM 004035343-0002 * 6/2017
EM 004035343-0003 * 6/2017

OTHER PUBLICATIONS

Coffee-mate Container, Nestle, yesterdayontuesday.com, posted by blogger Malia on Aug. 10, 2015 per wayback machine © 2019, online, site visited Jun. 26, 2019. Available from Internet, URL: <http://yesterdayontuesday.com/2015/08/smart-and-simple-coffee-station/> (Year: 2015).*

* cited by examiner

FIG. 1

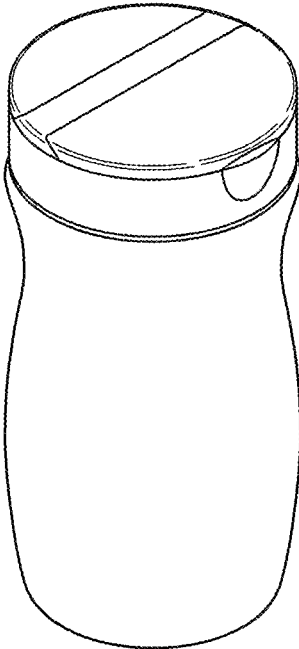

FIG. 2

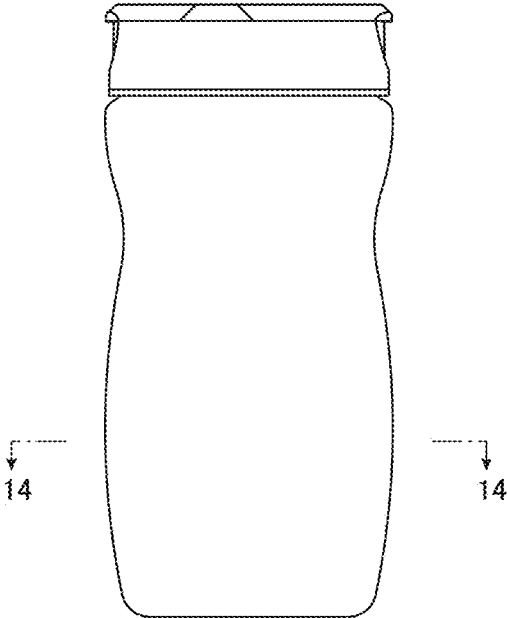

FIG. 3

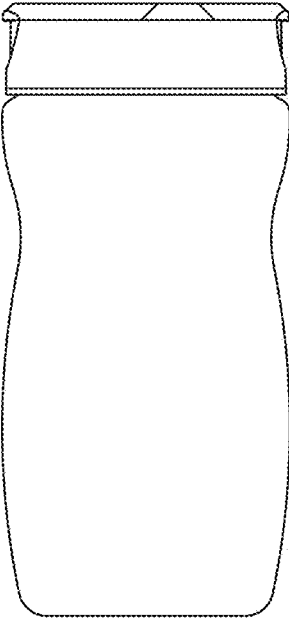

FIG. 4

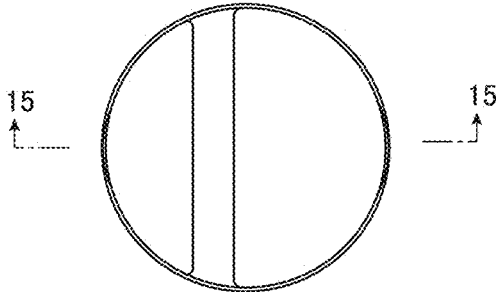

FIG. 5

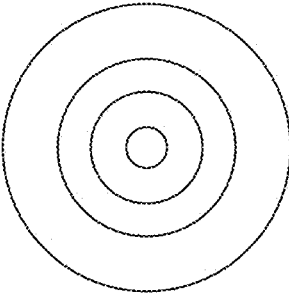

FIG. 6

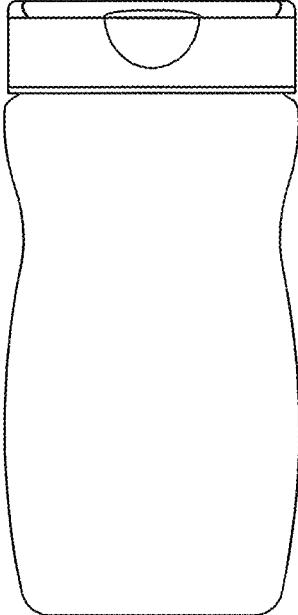

FIG. 7

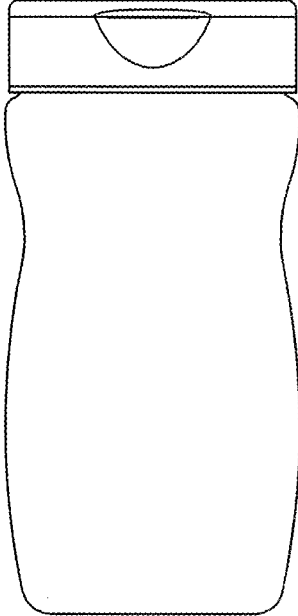

FIG. 8

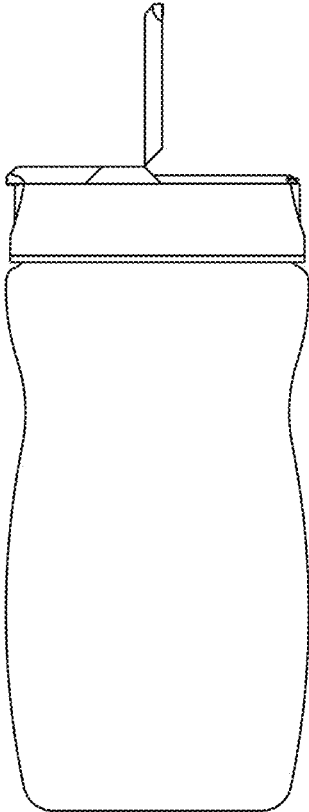

FIG. 9

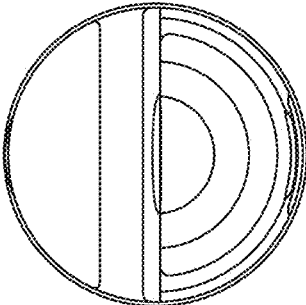

FIG. 10

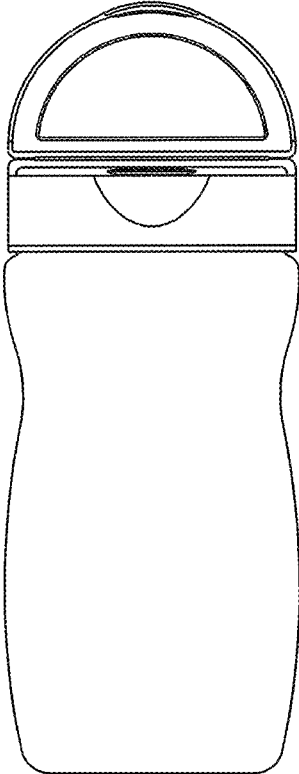

FIG. 11

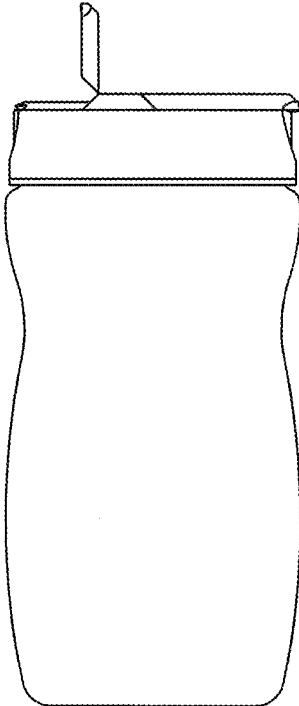

FIG. 12

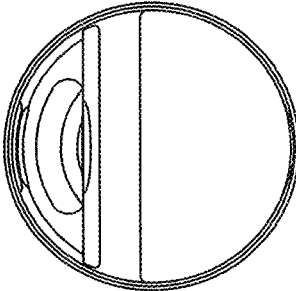

FIG. 13

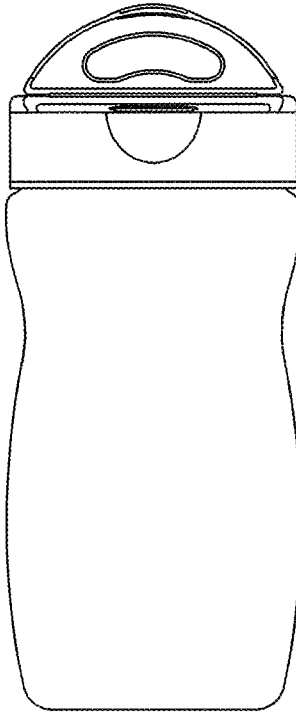

FIG. 14

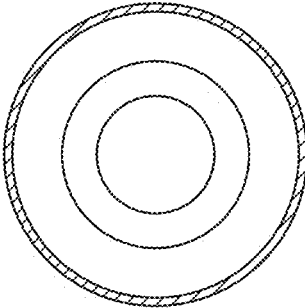

FIG. 15

