



US00D659413S

(12) **United States Design Patent**  
**Arko et al.**

(10) **Patent No.:** **US D659,413 S**

(45) **Date of Patent:** **\*\* May 15, 2012**

(54) **SEAT**

(75) Inventors: **Robert Peter Arko**, San Francisco, CA (US); **John R. Hamilton**, Grand Rapids, MI (US); **Matthew Hollingsworth**, San Francisco, CA (US)

(73) Assignee: **Steelcase Inc.**, Grand Rapids, MI (US)

(\*\*) Term: **14 Years**

(21) Appl. No.: **29/390,350**

(22) Filed: **Apr. 22, 2011**

(51) **LOC (9) Cl.** ..... **06-01**

(52) **U.S. Cl.** ..... **D6/334**

(58) **Field of Classification Search** ..... D6/334,  
D6/335, 337, 374, 379, 380, 381, 491, 492,  
D6/495, 500-502, 341; 297/118, 300.1,  
297/302.1, 311, 313, 353, 354.1, 445.1, 446.1,  
297/446.2, 447.4, 464, 465, 900, DIG. 2,  
297/DIG. 7; 5/12.1, 12.2

See application file for complete search history.

(56) **References Cited**

**U.S. PATENT DOCUMENTS**

2,217,426	A *	10/1940	Zareko	297/117
D169,911	S	6/1953	Netzer	
D170,088	S	7/1953	Hoffman	
D170,122	S	8/1953	Jorgensen	
D175,877	S	10/1955	Bartolucci	
D179,829	S	3/1957	Wilson	
2,793,685	A *	5/1957	Spitz	297/411.27
D186,308	S	10/1959	Knoll	
2,965,160	A	12/1960	Knoll	
2,979,122	A	4/1961	Knoll	
2,985,892	A	5/1961	Garrigus, Sr. et al.	
2,997,724	A	8/1961	Heumann	
3,328,810	A	7/1967	Berman	
3,380,777	A	4/1968	Bennett	
3,695,690	A *	10/1972	Carson	297/218.3

3,857,120	A *	12/1974	Acker	5/12.1
D234,331	S *	2/1975	Rocchis	D6/369
D244,069	S *	4/1977	Summer	D6/371
4,188,066	A *	2/1980	Terenzoni	297/440.23
D272,968	S	3/1984	Fairaizen	
4,621,381	A	11/1986	Schramek	
D329,543	S *	9/1992	Shields	D6/334
D360,310	S	7/1995	Stamberg et al.	
D373,257	S *	9/1996	Hutton	D6/381
D379,269	S *	5/1997	Hutton	D6/334
D384,827	S	10/1997	Hutton	
D385,122	S	10/1997	Hutton	
D410,800	S *	6/1999	Gomez	D6/369
D422,422	S *	4/2000	Black	D6/369
D429,082	S	8/2000	Desombre	

(Continued)

**OTHER PUBLICATIONS**

Metropolitan Furniture Corporation. "Contract Bench". Interiors catalog. Copyright Apr. 1961.

(Continued)

*Primary Examiner* — Sandra Snapp

(74) *Attorney, Agent, or Firm* — Quarles & Brady LLP

(57) **CLAIM**

The ornamental design for a seat, as shown and described.

**DESCRIPTION**

FIG. 1 is a left, top, front perspective view of a seat according to our new design, the bottom thereof is unseen in use;  
FIG. 2 is a top, rear perspective view from the right side thereof;  
FIG. 3 is a front elevational view thereof;  
FIG. 4 is a rear elevational view thereof;  
FIG. 5 is a right side elevational view thereof, the left side elevational view thereof being a mirror image of the right side shown; and,  
FIG. 6 is a top plan view thereof.

**1 Claim, 3 Drawing Sheets**

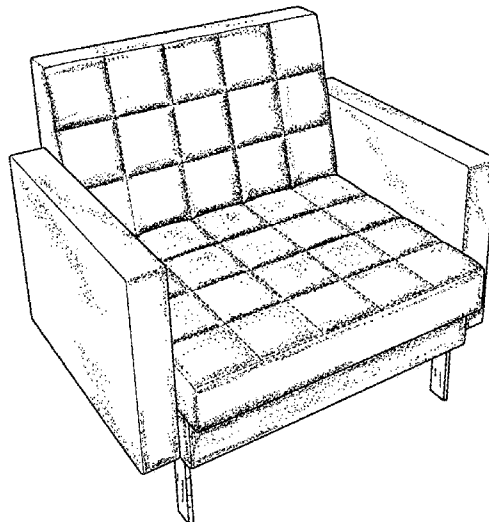

U.S. PATENT DOCUMENTS

D433,824 S 11/2000 King  
 D443,989 S 6/2001 Gomez  
 D444,305 S 7/2001 Mourgue  
 D455,281 S 4/2002 Andersen et al.  
 D455,282 S 4/2002 Andersen et al.  
 D473,723 S 4/2003 Pesso  
 D477,152 S 7/2003 Levy  
 D484,327 S 12/2003 Ricci  
 D485,086 S 1/2004 Gomez  
 D486,311 S \* 2/2004 Boydak ..... D6/335  
 D486,652 S \* 2/2004 Nemeth ..... D6/334  
 D489,188 S 5/2004 Ricci  
 D490,630 S 6/2004 Pesso  
 D495,153 S 8/2004 Ricci  
 D495,514 S 9/2004 Ricci  
 D495,892 S \* 9/2004 Ricci ..... D6/381  
 D495,893 S 9/2004 Ricci  
 D498,064 S 11/2004 Gomez  
 D498,075 S 11/2004 Mourgue  
 D498,941 S 11/2004 Ricci  
 6,824,220 B1 \* 11/2004 Davison ..... 297/440.14  
 D499,261 S 12/2004 Ricci  
 D501,330 S 2/2005 Gomez  
 D505,276 S 5/2005 Cronk et al.  
 D511,415 S 11/2005 Pesso  
 D515,334 S 2/2006 Natuzzi  
 D518,654 S 4/2006 Pesso  
 D527,541 S 9/2006 Natuzzi  
 D533,365 S \* 12/2006 Martin ..... D6/334  
 D538,054 S 3/2007 Lissoni  
 D539,561 S 4/2007 Martin  
 D542,560 S 5/2007 Ricci  
 D545,070 S 6/2007 Hutton  
 D549,470 S 8/2007 Hutton  
 D552,864 S \* 10/2007 Natuzzi ..... D6/381  
 D552,867 S \* 10/2007 Natuzzi ..... D6/381  
 D569,111 S 5/2008 Swanson  
 D569,112 S 5/2008 Swanson  
 D569,113 S 5/2008 Lewis  
 D571,574 S \* 6/2008 Natuzzi ..... D6/381  
 D572,916 S 7/2008 Galardo et al.  
 D573,358 S 7/2008 Gharabegian  
 D577,211 S 9/2008 Natuzzi  
 D577,222 S 9/2008 Natuzzi  
 D577,506 S 9/2008 Natuzzi  
 D580,670 S 11/2008 Weiss  
 D583,585 S \* 12/2008 Weiss ..... D6/381  
 D586,131 S 2/2009 Cramer et al.  
 D586,156 S 2/2009 Schweikarth et al.  
 D590,171 S 4/2009 Natuzzi  
 D590,623 S 4/2009 Natuzzi  
 D591,970 S 5/2009 Weiss  
 D592,416 S 5/2009 Weiss  
 D600,037 S 9/2009 Natuzzi  
 D601,825 S 10/2009 Starck  
 D603,617 S \* 11/2009 Weiss ..... D6/381  
 D603,618 S 11/2009 Weiss  
 D603,619 S 11/2009 Weiss

D604,957 S 12/2009 Weiss  
 D607,227 S 1/2010 Massaud  
 D613,960 S \* 4/2010 Griepentrog et al. .... D6/381  
 D614,419 S 4/2010 Andersen  
 D614,884 S 5/2010 Metcalf et al.  
 D615,315 S 5/2010 Andersen  
 D615,766 S 5/2010 Andersen  
 D615,767 S \* 5/2010 Griepentrog et al. .... D6/381  
 D618,007 S 6/2010 Andersen  
 D623,869 S 9/2010 Andersen  
 D628,403 S 12/2010 Starck  
 D630,029 S 1/2011 Delbridge  
 D650,605 S \* 12/2011 Haimoff et al. .... D6/369  
 2002/0000741 A1 \* 1/2002 Clay et al. .... 297/118

OTHER PUBLICATIONS

Metropolitan Furniture Corporation. "Contract B". Interiors catalog. Copyright Apr. 1961.  
 Metropolitan Furniture Corporation. "Contract C". Interior Design catalog. Copyright Aug. 1962.  
 Metropolitan Furniture Corporation. "506JVision". Palto alto Times, Copyright Nov. 19, 1957.  
 NLBAA Sofa, First Proof Journal Oregon Journal of CA 2-5511, Sunday, Oct. 11. No. 6226 Journal.  
 NLBAA Sofa, Sunset Magazine, Mar. 1961.  
 Metropolitan Furniture Company. "Sofa". Retailing Daily, Aug. 19, 1954, p. 10.  
 Metropolitan Furniture Company. "Chairs". Pennisula Living, Sep. 14-15, 1957, p. 25.  
 Metropolitan Furniture Company. "Sofa". Nat'l Furniture Review Aug. 15, 1961.  
 Metropolitan Furniture Company. Pierce Sofa, Nat'l Furniture Review, Aug. 15, 1961.  
 Metropolitan Furniture Company. Elegance/NLBAA Contract B Series, Contract Magazine, Feb. 1961.  
 Metropolitan Furniture Company. "Contract H". Metropolitan Furniture Sales Brochure 1961.  
 Metropolitan Furniture Company. "Contract B sofa, table and chair" National Furniture Review, Apr. 20, 1962.  
 Metropolitan Furniture Company. "Myriad collection", Printed publication published on or around Jun. 1961.  
 Metropolitan Furniture Company. "Contract B Table". Metropolitan Brochure.  
 Advertisement from Sloane's (San Francisco). San Francisciana.  
 Metropolitan Furniture Company. Advertisement/Brochure.  
 Metropolitan Furniture Company. "Elegance at a Price". In-house Metropolitan ad/brochure.  
 Metropolitan Furniture Company. "Sofa". Advertisement.  
 Sloane's (San Francisco) Sofas and Chairs. Advertisement.  
 Metropolitan Furniture Company. "Metropolitan's high-back chair".  
 Metropolitan Furniture Company. "Sofa". Fraser's /Berkeley Telegraph and Channing advertisement.  
 Metropolitan Furniture Company. "The Weekender Sofa/Bed". Furniture Forum catalog, section 1, p. 32.

\* cited by examiner

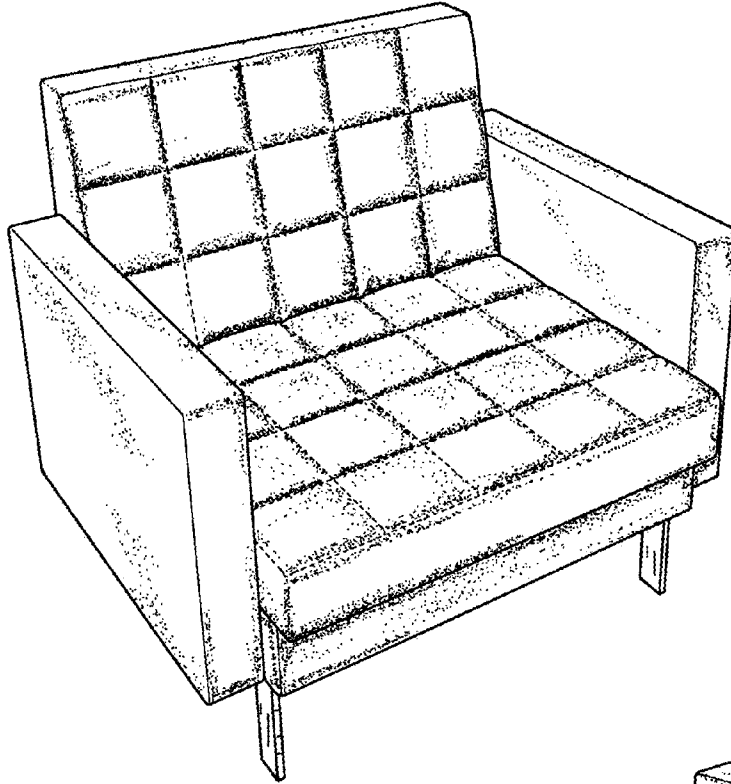

FIG. 1

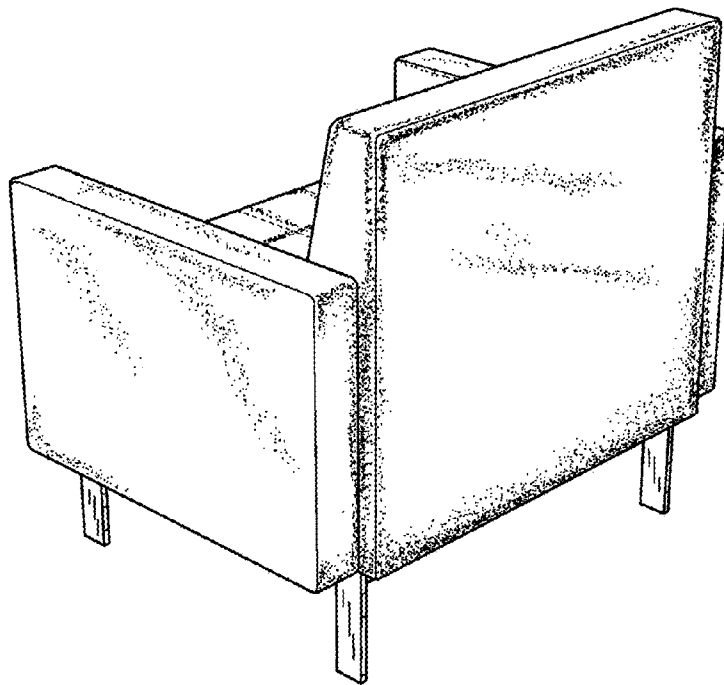

FIG. 2

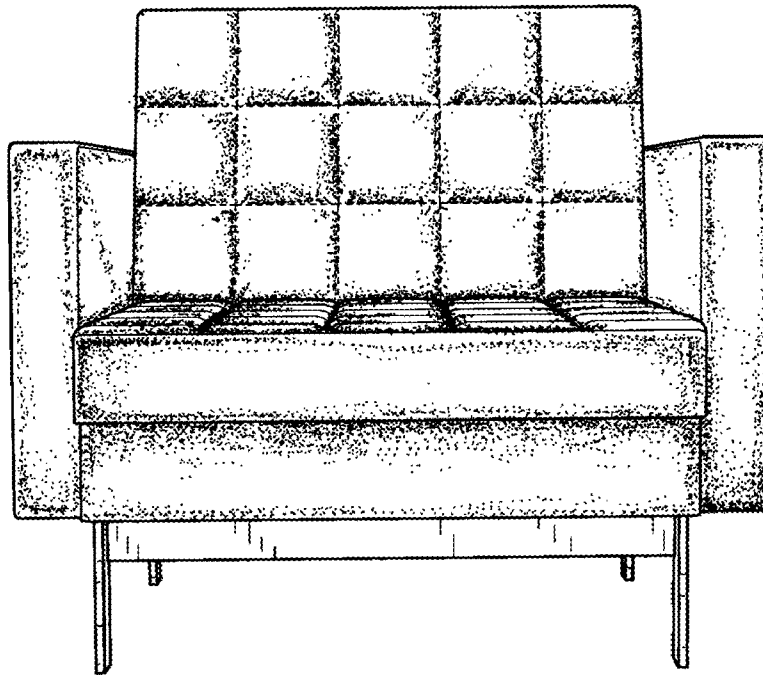

FIG. 3

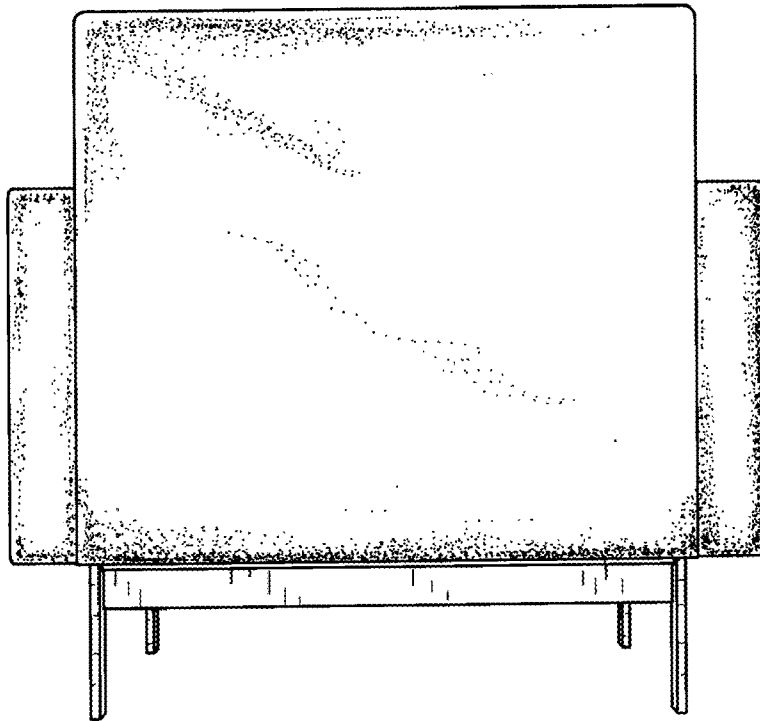

FIG. 4

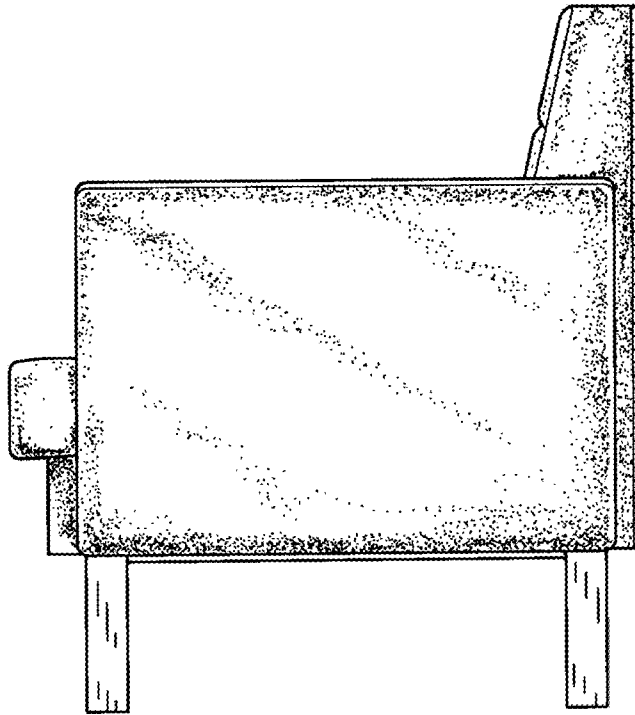

FIG. 5

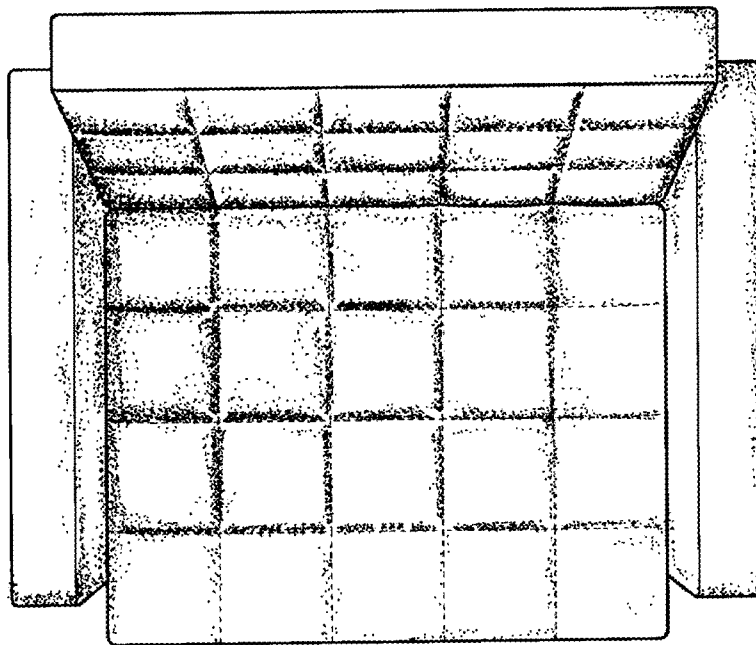

FIG. 6