



US00D512743S

(12) **United States Design Patent** (10) **Patent No.:** **US D512,743 S**  
**Killinger et al.** (45) **Date of Patent:** **\*\* \*Dec. 13, 2005**

- (54) **HOLDER**
- (75) Inventors: **Timothy D. Killinger**, Plainfield, IL (US); **Matthew G. Lerch**, Chicago, IL (US); **Aaron W. Smith**, Plainfield, IL (US); **Giberto Cavada, Jr.**, Melrose Park, IL (US); **Melanie Lyn Conklin**, Chicago, IL (US)
- (73) Assignee: **Rubbermaid Incorporated**, Fairlaw, OH (US)
- (\* ) Notice: This patent is subject to a terminal disclaimer.
- (\*\* ) Term: **14 Years**

4,320,837 A	3/1982	Carroll et al.	206/505
D310,925 S	10/1990	Mervar et al.	D6/567
D314,215 S	1/1991	Hawes, Jr. et al.	D19/90
5,036,988 A *	8/1991	Rouire	211/42
D335,996 S	6/1993	Evenson	D6/553
D381,691 S *	7/1997	Miyake	D19/90
D385,921 S *	11/1997	Tisbo	D19/90
D390,606 S *	2/1998	Cheris et al.	D19/90
D393,005 S	3/1998	Devito	D19/92
D400,926 S	11/1998	Stravitz	D19/90
D420,051 S	2/2000	Conley et al.	D19/90
D444,816 S	7/2001	Stravitz	D19/90
6,352,162 B1 *	3/2002	Yang et al.	211/43
D468,352 S *	1/2003	Chen	D19/34.1
D498,263 S *	11/2004	Goodman et al.	D19/90

\* cited by examiner

- (21) Appl. No.: **29/212,026**
- (22) Filed: **Aug. 25, 2004**

*Primary Examiner*—Jeffrey Asch  
*Assistant Examiner*—Elizabeth Albert  
 (74) *Attorney, Agent, or Firm*—Marshall, Gerstein & Borun LLP

**Related U.S. Application Data**

- (63) Continuation of application No. 29/202,743, filed on Apr. 2, 2004, now Pat. No. Des. 504,467.
- (51) **LOC (6) Cl.** ..... **19-02**
- (52) **U.S. Cl.** ..... **D19/90**
- (58) **Field of Search** ..... D19/65, 75, 78, D19/86, 90, 91, 95, 99, 100; D6/475; 211/10, 11, 13.1, 50, 113, 184; 229/178–182, 191, 198, 198.3; 206/425; 312/348.1; D9/432, 433

(57) **CLAIM**

The ornamental design for a “holder,” as shown and described.

**DESCRIPTION**

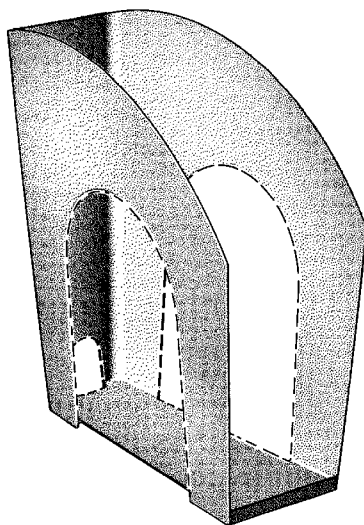
FIG. 1 is a perspective view of a holder showing our new design;  
 FIG. 2 is a front elevational view of the holder of FIG. 1;  
 FIG. 3 is a top plan view of the holder of FIG. 1;  
 FIG. 4 is a left side elevational view of the holder of FIG. 1, the right side elevational view being a mirror image thereof;  
 FIG. 5 is a bottom plan view of the holder of FIG. 1;  
 FIG. 6 is a rear elevational view of the holder of FIG. 1; and  
 FIG. 7 is another perspective view showing our new design.  
 The dashed lines are for illustrative purposes only and form no part of the claimed design.

(56) **References Cited**

**U.S. PATENT DOCUMENTS**

1,396,910 A *	11/1921	Annable	211/42
1,598,467 A *	8/1926	Weeks	211/43
D231,137 S *	4/1974	Juhlin	D19/90
3,934,724 A	1/1976	Johnson	206/507
4,102,453 A	7/1978	Carroll et al.	206/507
4,238,032 A	12/1980	Thurman	206/507

**1 Claim, 3 Drawing Sheets**



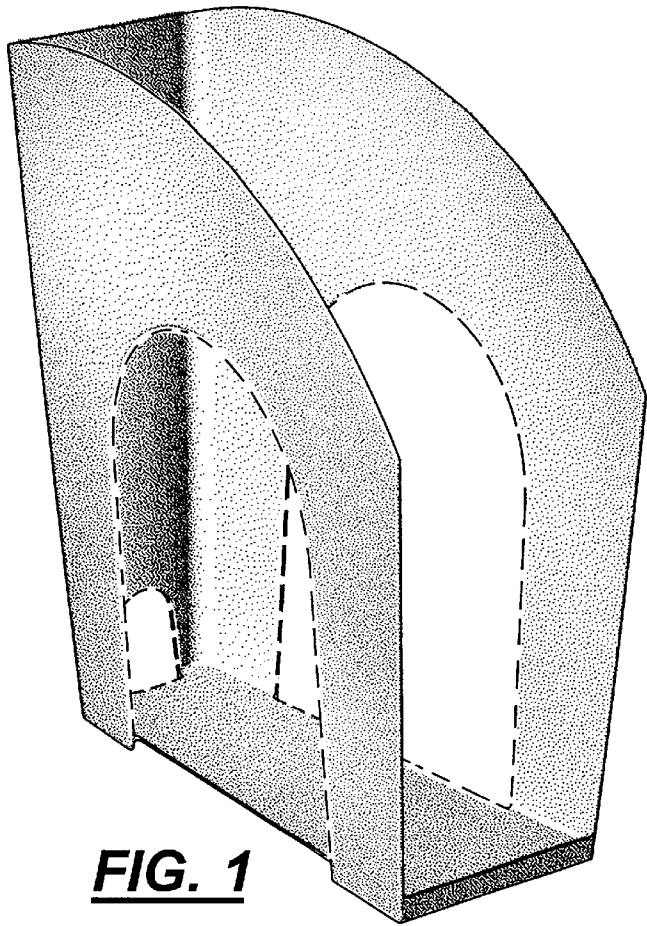


FIG. 2

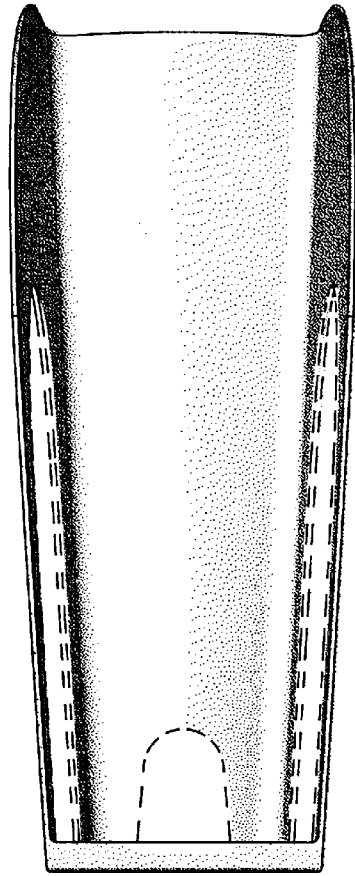
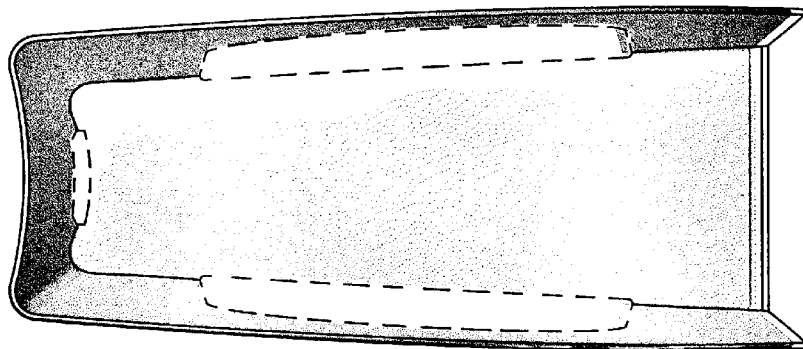
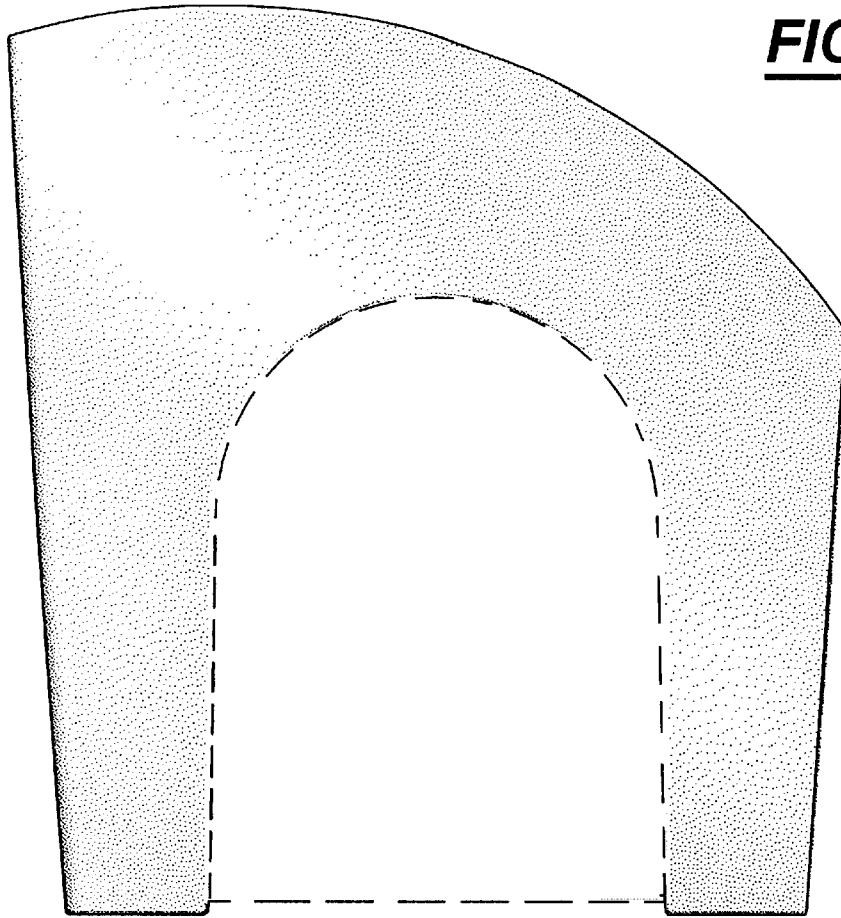


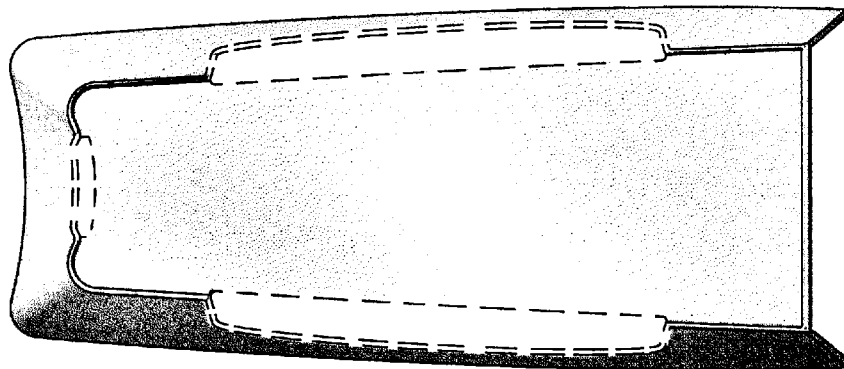
FIG. 3

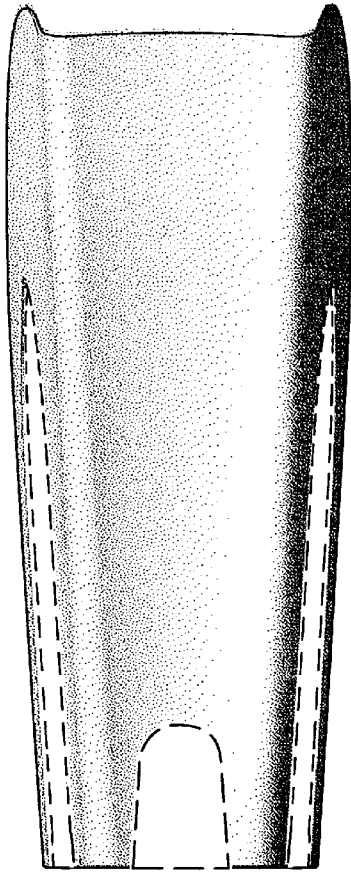




**FIG. 4**

**FIG. 5**





**FIG. 6**

**FIG. 7**

