



US00D890178S

(12) **United States Design Patent**
Xu

(10) **Patent No.:** **US D890,178 S**

(45) **Date of Patent:** **** Jul. 14, 2020**

(54) **MOUSE**

(71) Applicant: **SHENZHEN QIANHAI PATUOXUN NETWORK AND TECHNOLOGY CO., LTD**, Shenzhen (CN)

(72) Inventor: **Weiwei Xu**, Shenzhen (CN)

(73) Assignee: **SHENZHEN QIANHAI PATUOXUN NETWORK AND TECHNOLOGY CO., LTD**, Shenzhen (CN)

(**) Term: **15 Years**

(21) Appl. No.: **29/729,882**

(22) Filed: **Mar. 31, 2020**

(51) **LOC (12) Cl.** **14-02**

(52) **U.S. Cl.**
USPC **D14/408**

(58) **Field of Classification Search**
USPC D14/402-411, 356, 388, 389, 383-385, D14/417, 426; 345/156-167; 463/36-38; 358/471, 473; 273/148 B
CPC G06F 3/03543; G06F 2203/0333; G06F 3/039; G06F 3/038; G06F 2203/0384
See application file for complete search history.

(56) **References Cited**

U.S. PATENT DOCUMENTS

D479,843 S 9/2003 Mori
D481,391 S 10/2003 Lee et al.

D483,765 S *	12/2003	Ma	D14/408
D513,258 S *	12/2005	Huang	D14/408
D621,838 S *	8/2010	Hoehn	D14/408
D629,804 S *	12/2010	Hoehn	D14/408
D725,111 S *	3/2015	Jeong	D14/408
D737,274 S *	8/2015	Kuo	D14/408
D738,884 S *	9/2015	Zheng	D14/408
D863,302 S *	10/2019	Cheung	D14/408
D872,088 S *	1/2020	Turksu	D14/408
D872,089 S *	1/2020	Park	D14/408
D881,885 S *	4/2020	Zhan	D14/408
D882,574 S *	4/2020	Zhan	D14/408

* cited by examiner

Primary Examiner — Austin Murphy

(57) **CLAIM**

The ornamental design for a mouse, as shown and described.

DESCRIPTION

FIG. 1 is a perspective view of a mouse showing my new design;
FIG. 2 is another perspective view thereof;
FIG. 3 is a front elevational view thereof;
FIG. 4 is a rear elevational view thereof;
FIG. 5 is a left side elevational view thereof;
FIG. 6 is a right side elevational view thereof;
FIG. 7 is a top plan view thereof; and,
FIG. 8 is a bottom plan view thereof.
The broken lines in the drawings depict boundaries of the mouse that form no part of the claimed design.

1 Claim, 8 Drawing Sheets

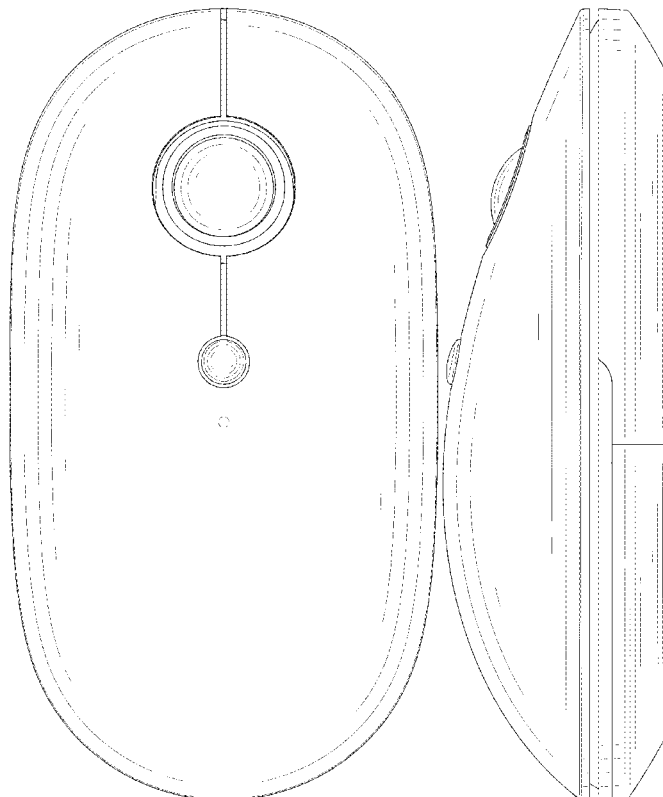

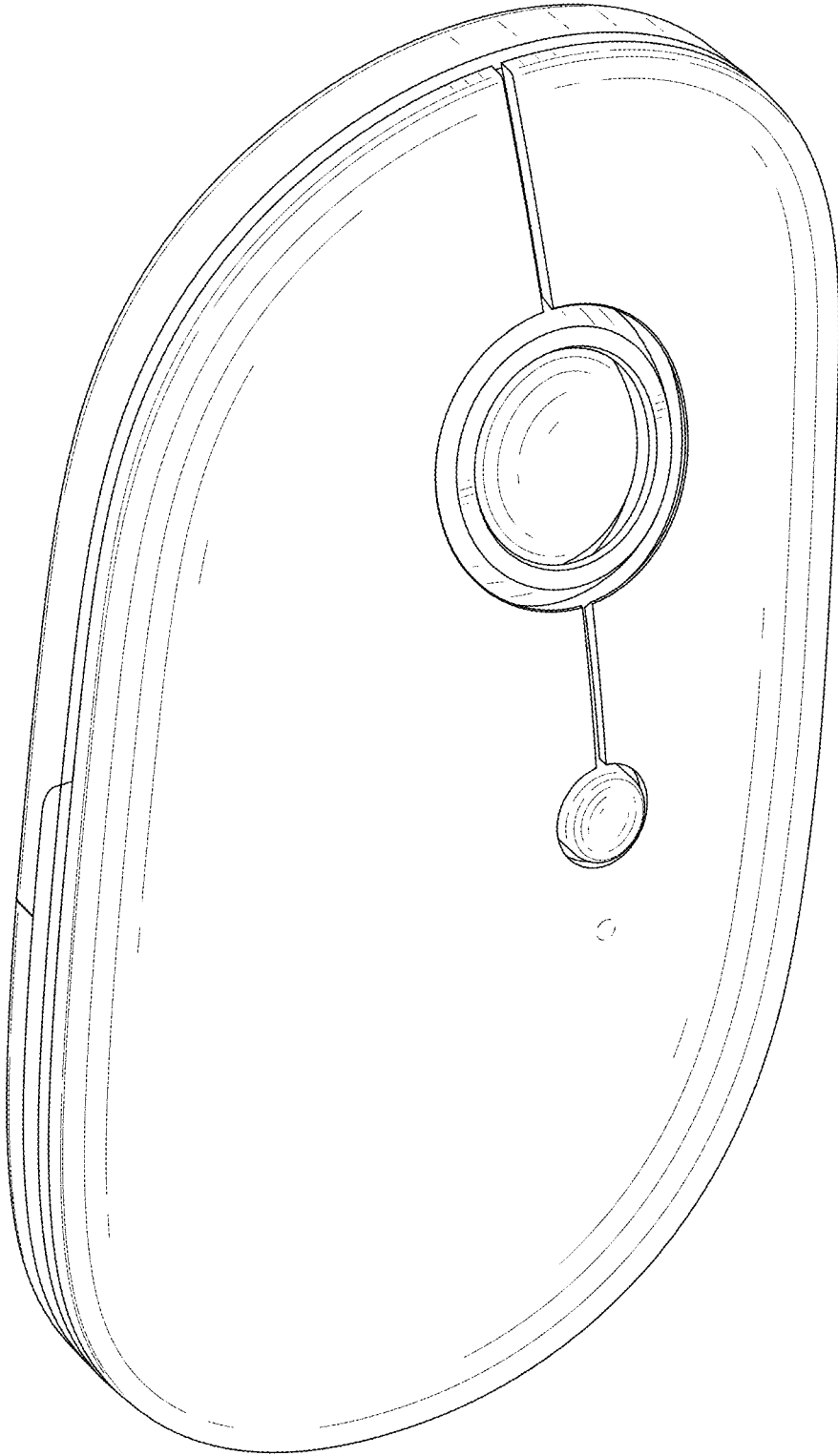

FIG. 1

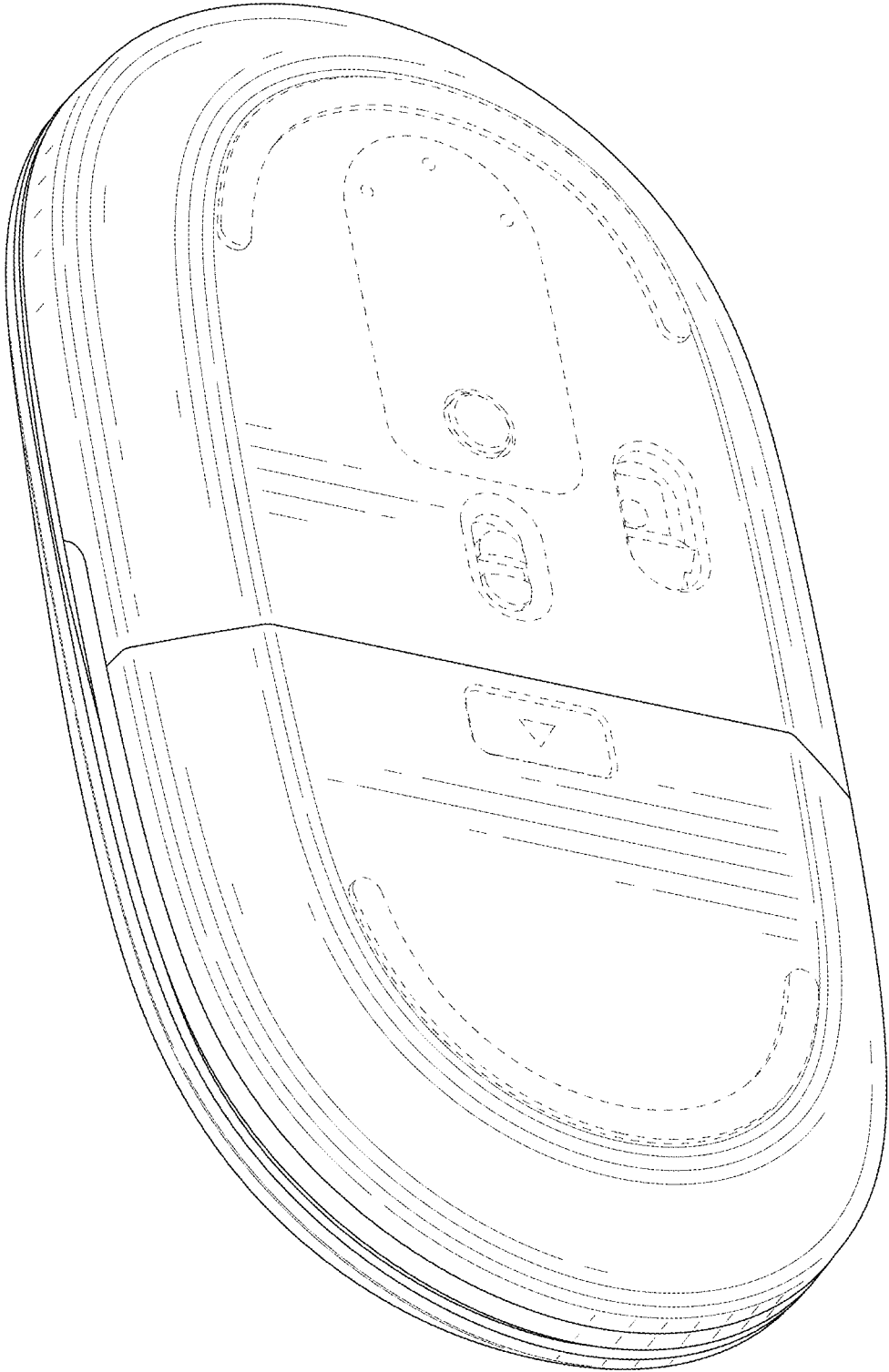

FIG. 2

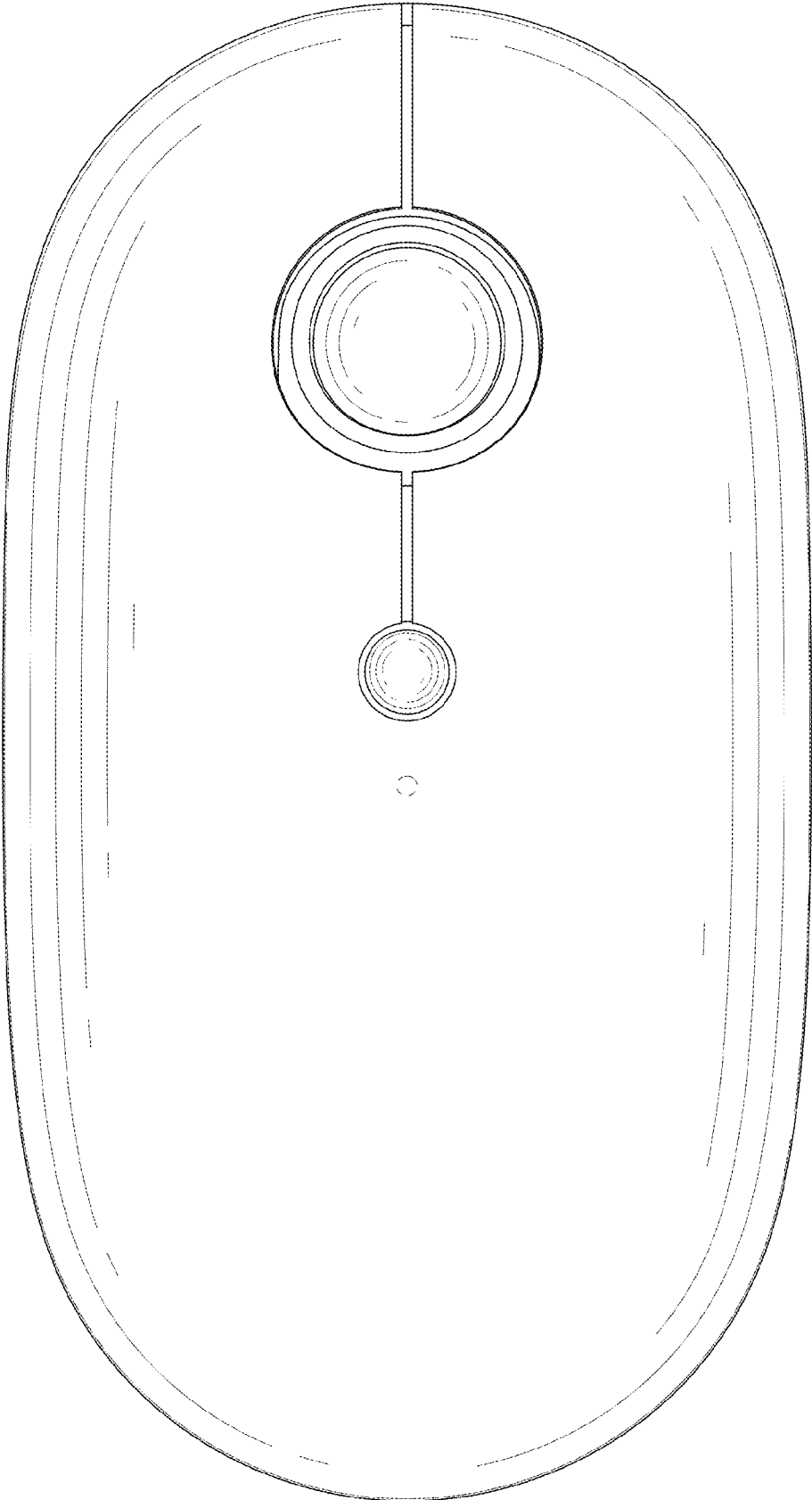

FIG. 3

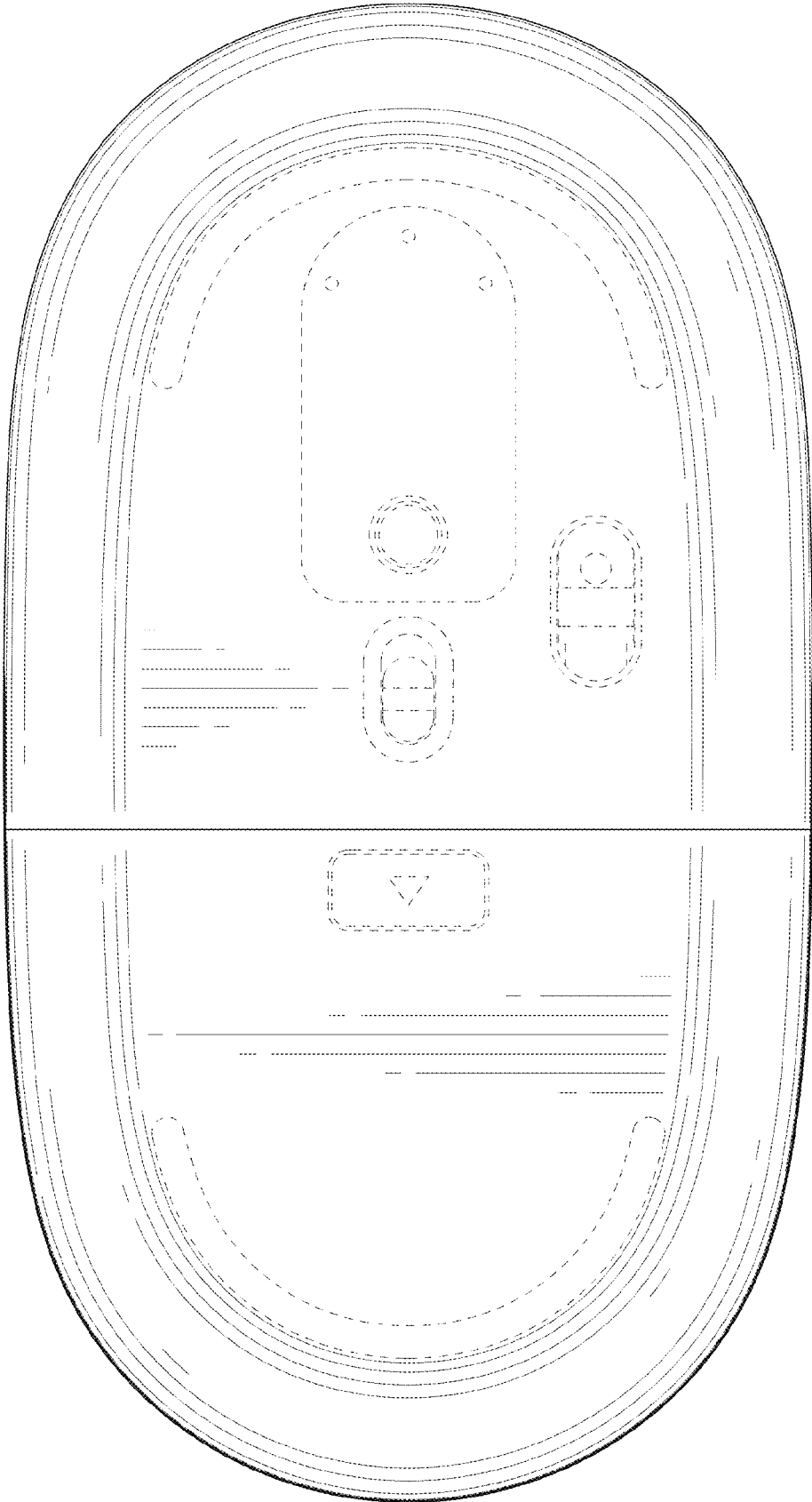

FIG. 4

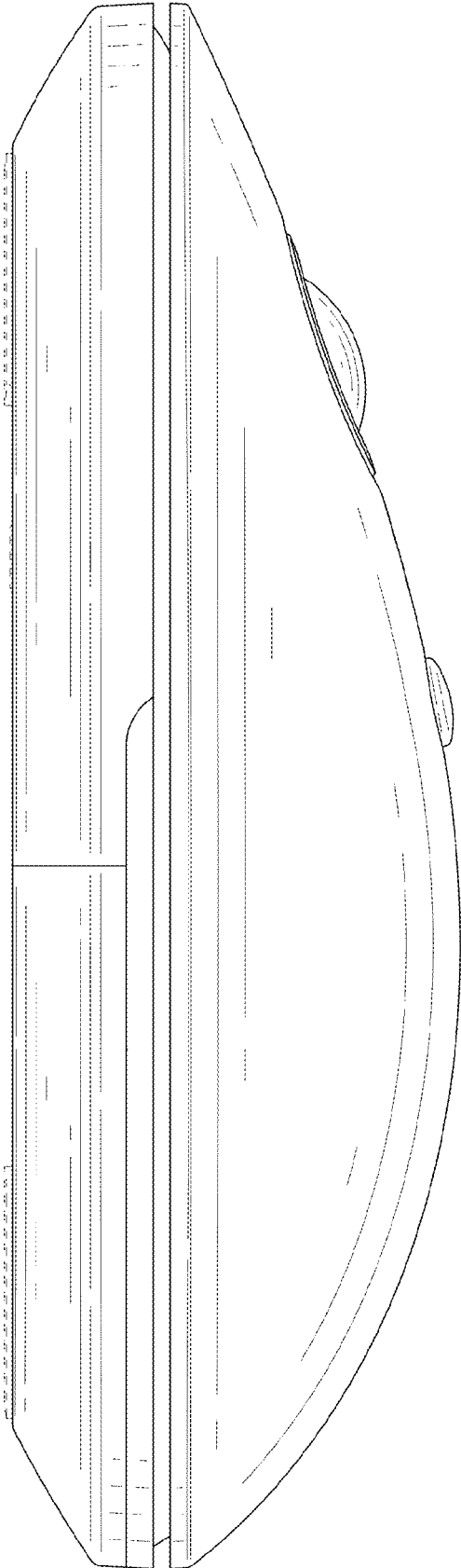

FIG. 5

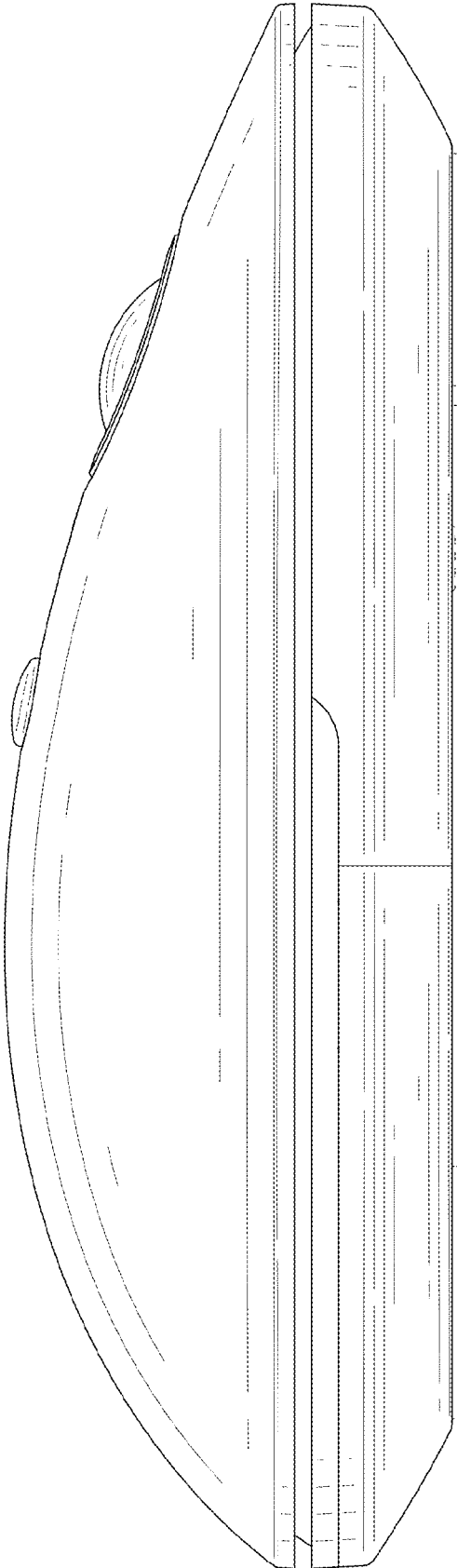

FIG. 6

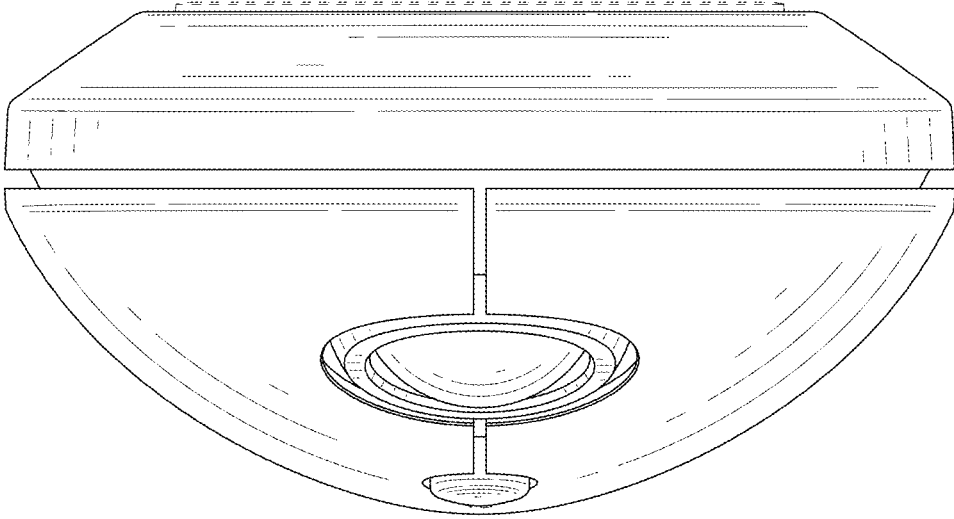

FIG. 7

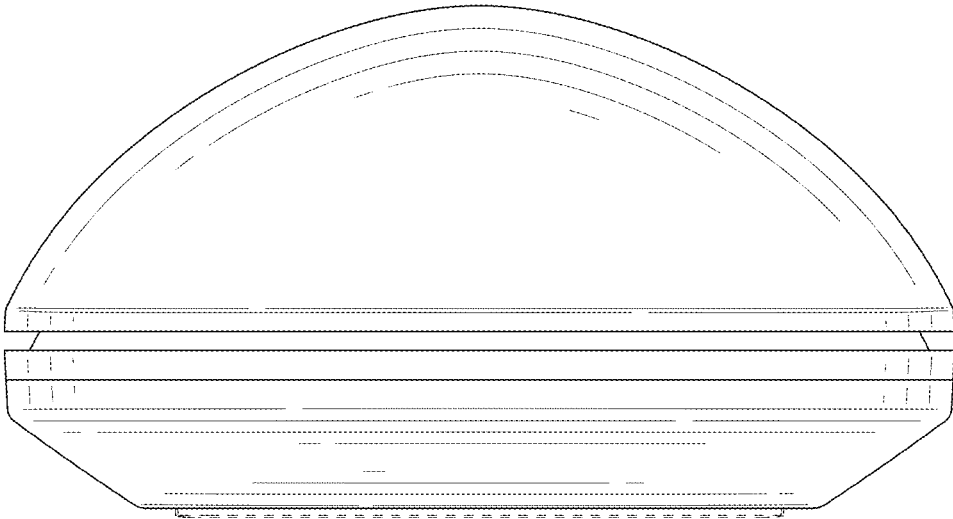

FIG. 8