



US00D778044S

(12) **United States Design Patent**
Lee et al.

(10) **Patent No.:** **US D778,044 S**
(45) **Date of Patent:** **** Feb. 7, 2017**

(54) BLUETOOTH EARSET CASE	8,498,679 B2 *	7/2013 Yu	H04M 1/0258
			379/430
(71) Applicant: LG ELECTRONICS INC. , Seoul (KR)	D724,453 S *	3/2015 Ogihara	D10/70
	D736,652 S *	8/2015 Isaacs	D10/32
	D747,714 S *	1/2016 Erbeus	D10/32
(72) Inventors: Sungcho Lee , Seoul (KR); Joonhyung Kim , Seoul (KR); Kyubong Choi , Seoul (KR)	9,347,749 B2 *	5/2016 Olah	F41H 9/10
	D759,516 S *	6/2016 Ling	D10/30
	2007/0042821 A1 *	2/2007 Lee	H04M 1/6066
			455/575.6

(73) Assignee: **LG Electronics Inc.**, Seoul (KR)

* cited by examiner

(**) Term: **15 Years**

Primary Examiner — Catheri Oliver-Garcia

(21) Appl. No.: **29/534,847**

(74) *Attorney, Agent, or Firm* — Birch, Stewart, Kolasch & Birch, LLP

(22) Filed: **Jul. 31, 2015**

(30) **Foreign Application Priority Data**

Feb. 2, 2015 (KR) 30-2015-0005715

(51) **LOC (10) Cl.** **03-01**

(52) **U.S. Cl.**
USPC **D3/218**

(58) **Field of Classification Search**

USPC . D3/218, 215; D10/30-33, 65, 70; 379/430;
381/182, 370, 381, 384, 388; 455/550.1,
455/569.1, 575.1, 575.2, 575.6;
D14/204-205, 240, 344

CPC A44C 5/00-5/16; G04B 37/00-37/228;
H04R 1/10; H04R 1/1041; H04R 2420/07;
H04M 1/0258; H04M 1/6066; H04M
2250/22; F41H 9/10

See application file for complete search history.

(56) **References Cited**

U.S. PATENT DOCUMENTS

D637,918 S * 5/2011 Cobbett D10/31
D655,497 S * 3/2012 Stanley D3/218

(57) **CLAIM**

The ornamental design for a Bluetooth earset case, as shown and described.

DESCRIPTION

FIG. 1 is a perspective view of a Bluetooth earset case showing our new design;
FIG. 2 is a front view thereof;
FIG. 3 is a rear view thereof;
FIG. 4 is a left side view thereof;
FIG. 5 is a right side view thereof;
FIG. 6 is a top plan view thereof;
FIG. 7 is a bottom plan view thereof;
FIG. 8 is an exploded perspective view thereof; and,
FIG. 9 is a reference view thereof showing an example of the usage of the subject design in which time is indicated on the display part.

The broken lines depict portions of the Bluetooth earset case that form no part of the claimed design,

1 Claim, 8 Drawing Sheets

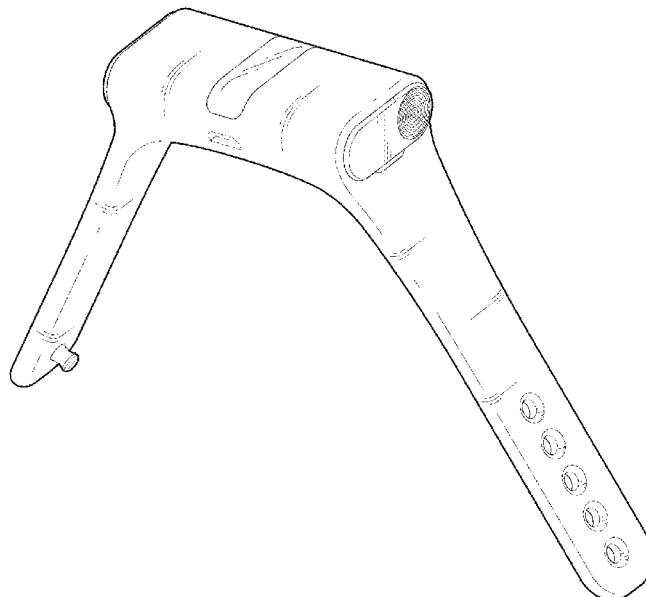

FIG. 1

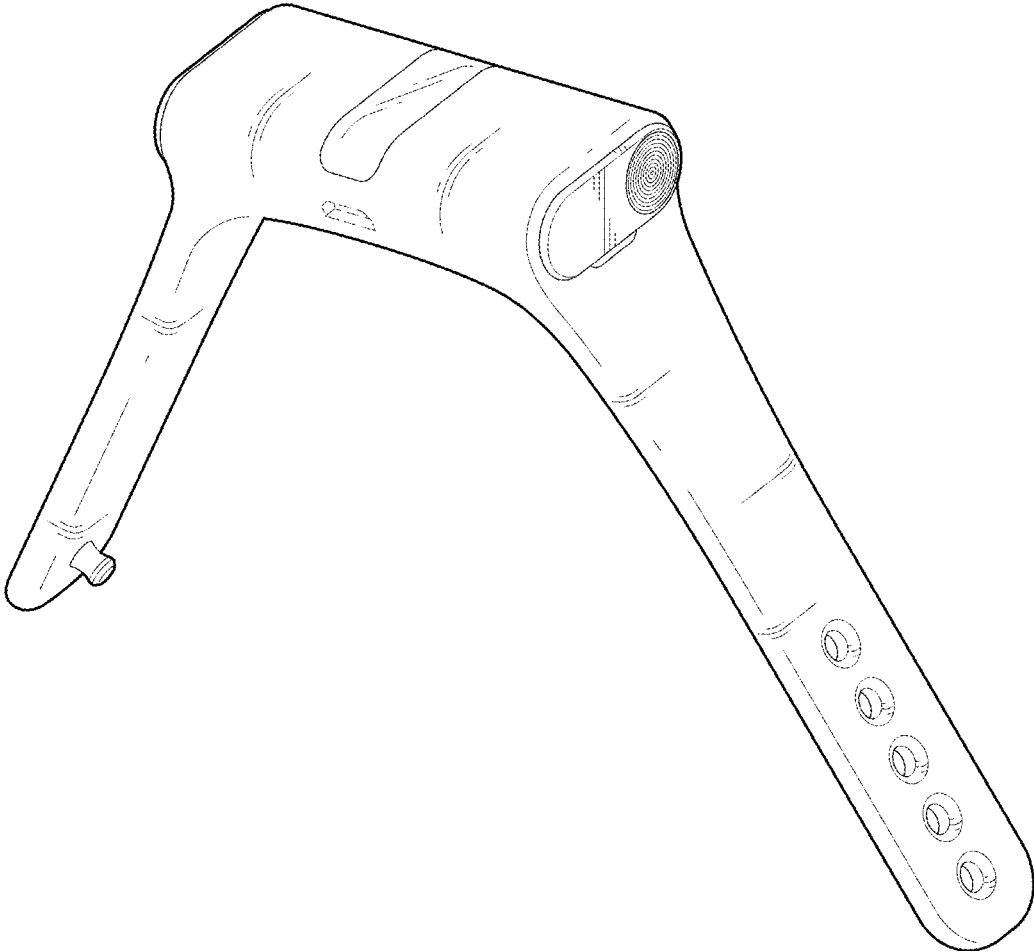

FIG. 2

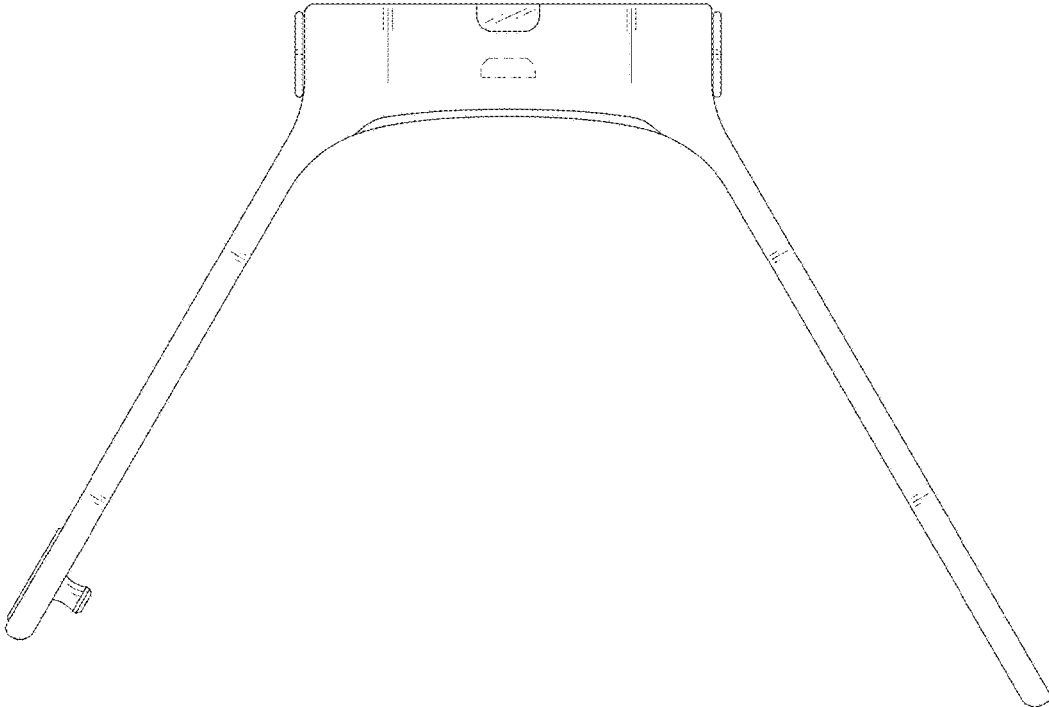

FIG. 3

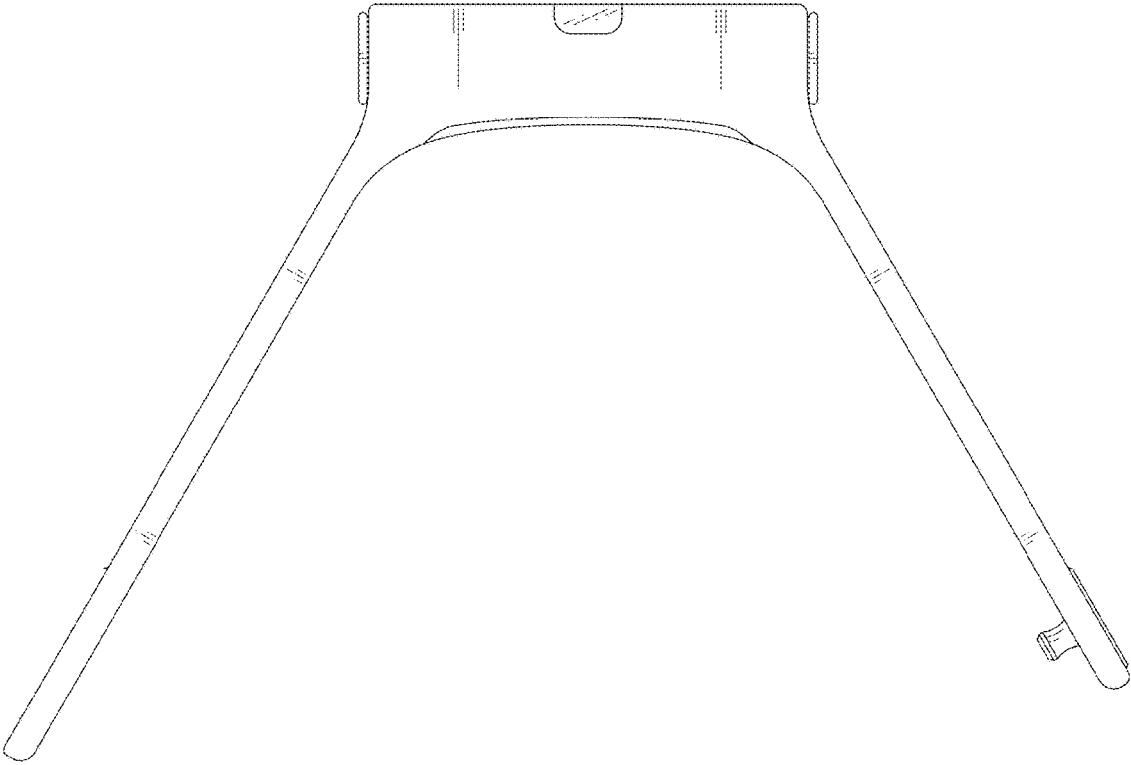

FIG. 4

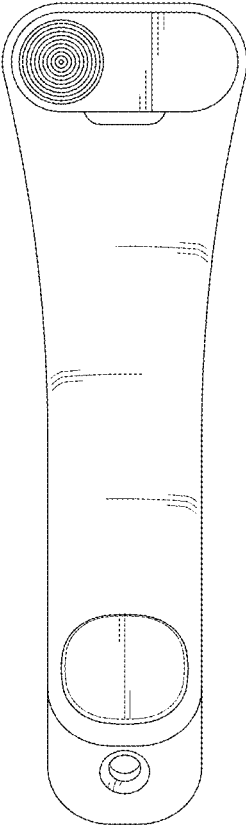

FIG. 5

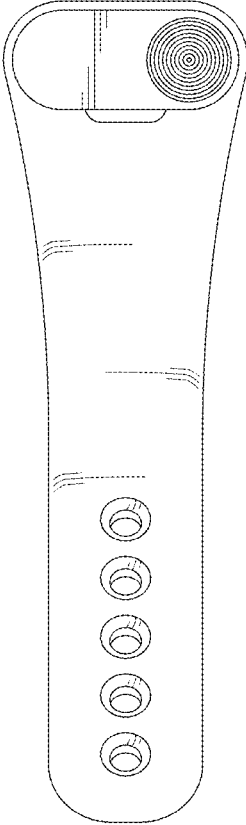

FIG. 6

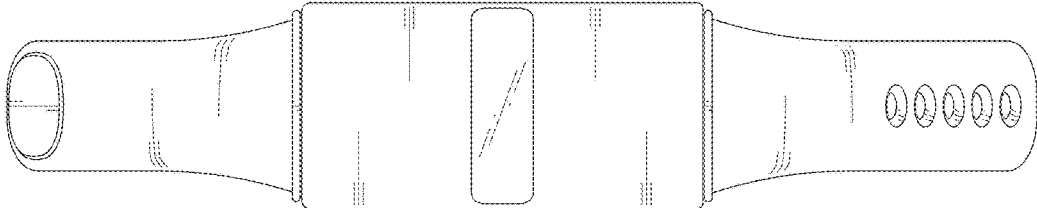

FIG. 7

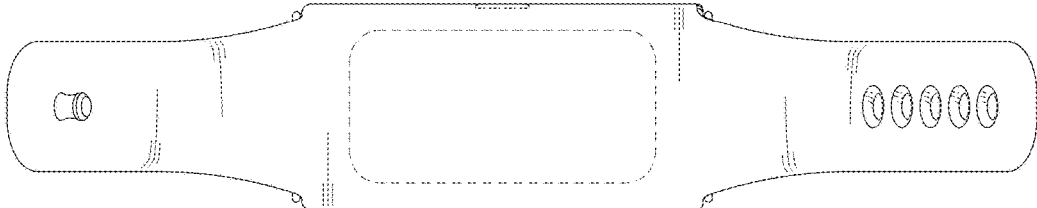

FIG. 8

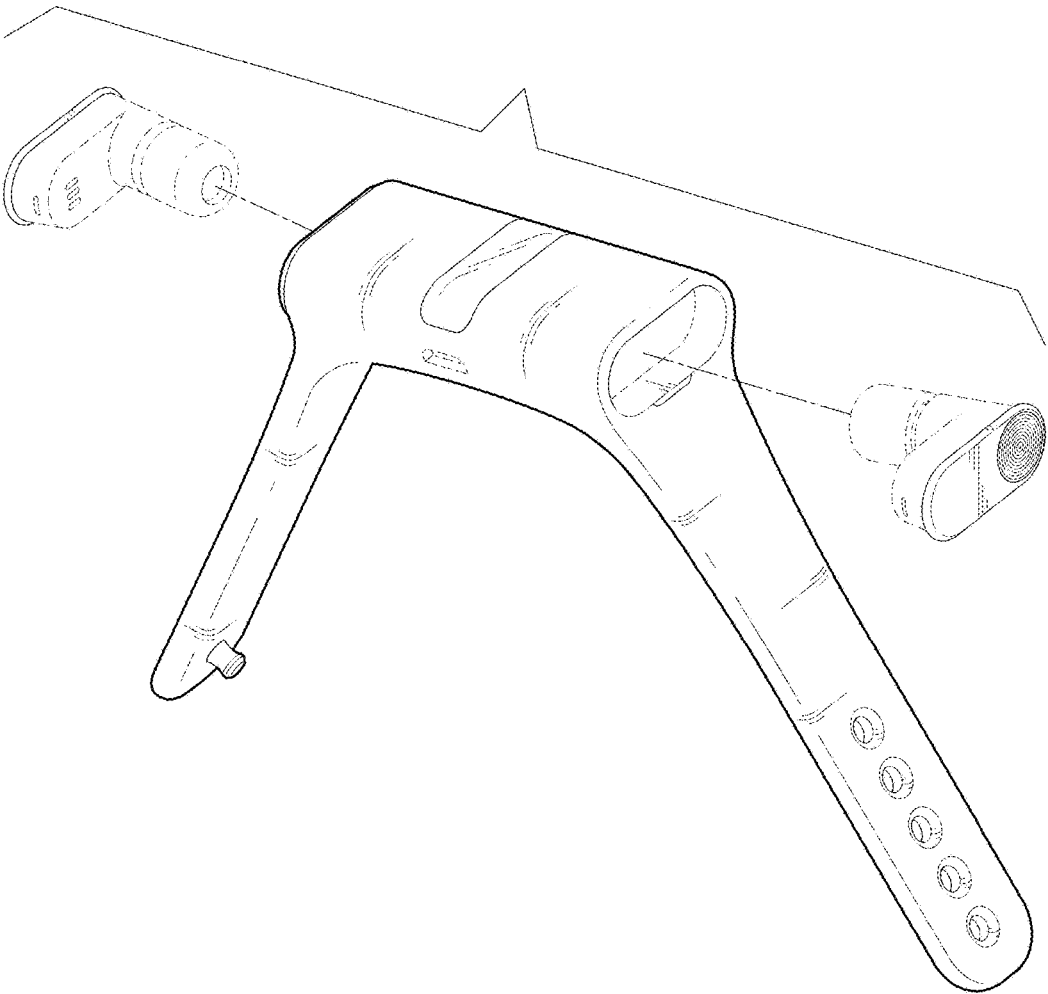

FIG. 9

