



US00D781492S

(12) **United States Design Patent**
Reynolds

(10) **Patent No.:** **US D781,492 S**

(45) **Date of Patent:** **** Mar. 14, 2017**

(54) **HORTICULTURE GROW LIGHT**

- (71) Applicant: **IP Holdings, LLC**, Vancouver, WA (US)
- (72) Inventor: **Christopher Reynolds**, Vancouver, WA (US)
- (73) Assignee: **IP Holdings, LLC**, Vancouver, WA (US)
- (**) Term: **15 Years**
- (21) Appl. No.: **29/572,282**
- (22) Filed: **Jul. 26, 2016**

Related U.S. Application Data

- (63) Continuation of application No. 29/531,242, filed on Jun. 24, 2015.
- (51) **LOC (10) Cl.** **29-99**
- (52) **U.S. Cl.**
USPC **D26/118**
- (58) **Field of Classification Search**
USPC ... D26/9, 10, 12, 13, 15, 16, 24, 51, 61, 72, D26/76, 80, 81, 85, 86, 88, 90, 113, 118,
(Continued)

(56) **References Cited**

U.S. PATENT DOCUMENTS

- 32,722 A 7/1861 Schmidlin
 - D46,253 S 8/1914 Kopp
- (Continued)

FOREIGN PATENT DOCUMENTS

- CA 2034710 A1 8/1991
 - CA 1314529 C 3/1993
- (Continued)

OTHER PUBLICATIONS

Sun System 630 Ceramic Metal Halide 120v Specifications, GrowersHouse.com, update on Sep. 9, 2014, Online. Site visited Feb. 3, 2015. http://growershouse.com/aitdownloadablefiles/download/aitfile/aitfile_id/583/.

(Continued)

Primary Examiner — Brian N Vinson

(74) *Attorney, Agent, or Firm* — J. Douglas Wells

(57) **CLAIM**

The ornamental design for a horticulture grow light, as shown and described.

DESCRIPTION

FIG. 1 is a perspective view of a horticulture grow light, as viewed from below, showing my new design;
 FIG. 2 is a perspective view of the light shown in FIG. 1, as viewed from above;
 FIG. 3 is a left side view of the light shown in FIG. 1;
 FIG. 4 is a right side view of the light shown in FIG. 1;
 FIG. 5 is a front elevation view of the light shown in FIG. 1;
 FIG. 6 is a rear elevation view of the light shown in FIG. 1;
 FIG. 7 is a bottom plan view of the light shown in FIG. 1; and,
 FIG. 8 is a top plan view of the light shown in FIG. 1.
 The broken-line disclosure shown in the views is understood to represent portions of the article in which the claimed design is embodied, but which form no part of the claimed design.

1 Claim, 6 Drawing Sheets

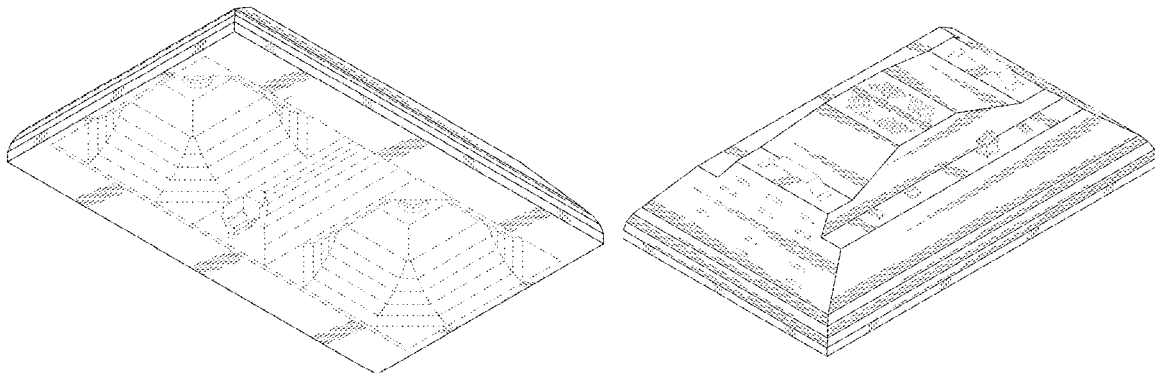

(58) **Field of Classification Search**
 USPC D26/119, 120, 122, 128, 129, 138, 143,
 D26/144
 CPC B60Q 1/04; B60Q 1/26; F21S 8/026; F21S
 8/04; F21V 21/02; F21V 29/004; F21V
 21/04; F21V 29/2212; F21V 7/22; F21V
 29/83; F21V 37/002; F21V 7/00; F21L
 19/00; F23D 11/443; F21Y 2101/02;
 A61L 9/037
 See application file for complete search history.

(56) **References Cited**
 U.S. PATENT DOCUMENTS

1,410,945	A	3/1922	Mayfield	4,939,629	A	7/1990	Glanton
1,547,026	A	7/1925	Canney	D311,597	S	10/1990	Poot
1,798,567	A	3/1931	Wagenhorst	4,970,428	A	11/1990	Hayakawa
D85,049	S	9/1931	Kopp	4,980,809	A	12/1990	Baldwin
D85,382	S	10/1931	Guth	D316,301	S	4/1991	Michael
1,848,734	A	3/1932	Luce	5,065,294	A	11/1991	Poot
1,873,310	A	8/1932	Doane	5,072,349	A	12/1991	Waniga
1,930,070	A	10/1933	Zecher	D323,897	S	2/1992	Compton
1,987,705	A	1/1935	Pedersen	5,192,129	A	3/1993	Figuroa
D106,614	S	10/1937	Waterbury	5,199,784	A	4/1993	Hempleman
2,194,841	A	3/1940	Welch	5,253,152	A	10/1993	Yang
D119,800	S	4/1940	Carter	5,353,746	A	10/1994	Del Rosario
D123,768	S	12/1940	Scribner	D352,126	S	11/1994	Ruud
D125,559	S	3/1941	Biller	5,440,470	A	8/1995	Ly
2,242,590	A	5/1941	Marcel	5,457,450	A	10/1995	Deese
D128,049	S	7/1941	Kurtz	5,461,554	A	10/1995	Leonetti
D135,375	S	3/1943	Biller	D365,159	S	12/1995	Tinen
2,339,100	A	1/1944	Netting	5,486,737	A	1/1996	Hrubowchak
2,348,617	A	5/1944	Furedy	5,510,676	A	4/1996	Cottaar
D156,014	S	11/1949	Lazerson	D373,000	S	8/1996	Brady
2,492,946	A	1/1950	Barber	5,555,162	A	9/1996	Shemitz
D174,221	S	3/1955	Hatch	5,568,680	A	10/1996	Parker
2,740,883	A	4/1956	Kruger	5,570,947	A	11/1996	Felland
2,741,694	A	4/1956	Wiig	D376,437	S	12/1996	Karlo
2,998,511	A	8/1961	Chan	D377,993	S	2/1997	Herst
3,025,391	A	3/1962	Golko	5,621,267	A	4/1997	Shaffner
D193,802	S	10/1962	Thomson	D383,243	S	9/1997	Fry
D195,012	S	4/1963	Hoyle	5,698,947	A	12/1997	Choi
3,125,301	A	3/1964	Stotter	5,702,179	A	12/1997	Sidwell
3,263,071	A	7/1966	Fabbri	D391,632	S	3/1998	Thomas
3,272,978	A	9/1966	Jackson	D396,319	S	7/1998	Sutton
3,322,946	A	5/1967	Cooper	D397,481	S	8/1998	Schafer
3,420,995	A	1/1969	Dunckel	D399,328	S	10/1998	Compton
D213,391	S	2/1969	Bruno	D399,329	S	10/1998	Compton
3,433,941	A	3/1969	Hall	D399,587	S	10/1998	Compton
3,675,008	A	7/1972	Hill	D400,289	S	10/1998	Wardenburg
3,701,898	A	10/1972	McNamara, Jr.	5,816,694	A	10/1998	Ideker
3,755,667	A	8/1973	Price	D401,006	S	11/1998	Edwards
3,829,677	A	8/1974	DeLlano	D405,976	S	2/1999	Beall
3,902,059	A	8/1975	McNamara, Jr.	5,896,004	A	4/1999	Feldman
3,911,265	A	10/1975	Landrum	5,924,789	A	7/1999	Thornton
4,028,542	A	6/1977	McReynolds, Jr.	5,932,955	A	8/1999	Berger
D245,016	S	7/1977	Barr	5,938,317	A	8/1999	Thornton
4,037,096	A	7/1977	Brengord	D415,304	S	10/1999	Brown
4,078,169	A	3/1978	Armstrong	5,983,564	A	11/1999	Stragnola
4,175,360	A	11/1979	Mulvey	5,987,697	A	11/1999	Song
4,229,782	A	10/1980	Ruud	5,999,943	A	12/1999	Nori
D259,738	S	6/1981	Boschetti	D418,626	S	1/2000	Herst
4,308,573	A	12/1981	McNamara, Jr.	D419,248	S	1/2000	Lyons
D262,659	S	1/1982	Lalita	6,024,468	A	2/2000	Kassay
D266,578	S	10/1982	Moshier	6,042,250	A	3/2000	Stragnola
D268,287	S	3/1983	Boschetti	6,051,927	A	4/2000	Graser
D270,577	S	9/1983	DeVos	6,053,624	A	4/2000	Cronk
4,446,506	A	5/1984	Larson	D425,237	S	5/2000	Scott
4,531,180	A	7/1985	Hernandez	D425,652	S	5/2000	Brok
4,616,293	A	10/1986	Baliozian	D426,010	S	5/2000	Compton
4,669,033	A	5/1987	Lee	6,061,690	A	5/2000	Nori
D290,662	S	7/1987	Basil	6,065,849	A	5/2000	Chen
D300,877	S	4/1989	Cyr	6,070,173	A	5/2000	Huber
4,855,884	A	8/1989	Richardson	6,076,944	A	6/2000	Maranon
4,893,221	A	1/1990	Friedman	6,079,851	A	6/2000	Altman
4,933,821	A	6/1990	Anderson	D428,516	S	7/2000	Reo D26/118
				6,094,919	A	8/2000	Bhatia
				6,111,739	A	8/2000	Wu
				6,152,579	A	11/2000	Reed et al.
				D439,008	S	3/2001	Kim
				6,230,497	B1	5/2001	Morris
				D443,949	S	6/2001	DiMonte
				6,247,830	B1	6/2001	Winnett
				D445,943	S	7/2001	Littman
				6,257,735	B1	7/2001	Baar
				6,267,483	B1	7/2001	Hembery
				D447,272	S	8/2001	Smith D26/118
				6,279,012	B1	8/2001	Sexton
				6,299,327	B1	10/2001	Camarota
				D452,559	S	12/2001	Schonberger
				6,343,984	B1	2/2002	Langdon
				6,371,630	B1	4/2002	Unger
				D456,927	S	5/2002	Russello

(56)

References Cited

U.S. PATENT DOCUMENTS

D456,928 S	5/2002	Russello		D633,640 S	3/2011	Wauters	
D456,938 S *	5/2002	Wardenburg	D26/118	D634,060 S *	3/2011	Wardenburg	D26/118
D459,825 S	7/2002	Field		D634,240 S	3/2011	Junkeer	
6,488,387 B2	12/2002	Wardenburg		D634,468 S	3/2011	Hargreaves	
D469,564 S	1/2003	Brok		D634,469 S *	3/2011	Hargreaves	D26/118
6,527,422 B1	3/2003	Hutchison		D637,162 S	5/2011	Bridgman	
6,548,948 B1	4/2003	Muessli		D637,341 S	5/2011	Wardenburg	
6,595,662 B2	7/2003	Wardenburg		D637,752 S	5/2011	Mekhtarian	
6,601,972 B2	8/2003	Sei		D640,404 S	6/2011	Chipperfield	
6,658,652 B1	12/2003	Alexander		7,959,331 B2	6/2011	Ho	
6,679,619 B2	1/2004	Saieva		7,972,044 B2	7/2011	Burkhauser	
D486,593 S	2/2004	Griffin		D644,185 S	8/2011	Hargreaves	
6,688,759 B1	2/2004	Hadjimichael		7,987,632 B2	8/2011	May	
6,709,131 B1	3/2004	Herst		8,018,630 B2	9/2011	Herloski	
6,729,383 B1	5/2004	Cannell		8,038,318 B2	10/2011	Plunk	
6,783,263 B1	8/2004	Cronk		D648,652 S	11/2011	Hawkins	
D496,121 S	9/2004	Santoro		D649,685 S	11/2011	Trzesniowski	
D499,505 S	12/2004	Benensohn		D650,515 S	12/2011	Bradley	
D504,343 S	4/2005	Ek		D650,935 S	12/2011	Beghelli	
6,885,134 B2	4/2005	Kurashima		8,113,696 B2	2/2012	Striebel	
6,908,212 B2	6/2005	Schultz		D655,403 S	3/2012	Zakula	
7,011,424 B1	3/2006	Poulson		D657,748 S	4/2012	Hargreaves	
7,083,309 B2	8/2006	Chan		D660,252 S	5/2012	Hargreaves	
7,131,753 B1	11/2006	Edwards, Jr.		D661,833 S	6/2012	Imajo	
7,156,539 B2	1/2007	Cronk		8,209,912 B2	7/2012	Hargreaves et al.	
7,175,309 B2	2/2007	Craw		8,215,799 B2	7/2012	Vanden Eynden	
D542,460 S	5/2007	Hargreaves		D667,584 S	9/2012	Beghelli	
D543,652 S *	5/2007	Hargreaves	D26/118	D668,370 S	10/2012	Guercio	
D543,654 S	5/2007	Hargreaves		D671,259 S	11/2012	Chen	
D543,655 S	5/2007	Hargreaves		D672,908 S	12/2012	Wilcox	
7,213,948 B2	5/2007	Hein		D673,324 S	12/2012	Mayfield	
D544,136 S	6/2007	Hargreaves		8,334,640 B2	12/2012	Reed	
D544,138 S	6/2007	Hargreaves		D675,369 S *	1/2013	Michaud	D26/118
D544,139 S	6/2007	Hargreaves		8,348,481 B2	1/2013	Chang	
D544,626 S	6/2007	Hargreaves		D675,772 S	2/2013	Tran	
D544,980 S	6/2007	Hargreaves		8,371,726 B2	2/2013	Collins	
D544,981 S	6/2007	Hargreaves		D678,597 S	3/2013	Lehman	
D544,982 S	6/2007	Hargreaves		D678,599 S	3/2013	Boyer et al.	
D544,983 S	6/2007	Hargreaves		D679,848 S	4/2013	Pickard	
D544,984 S	6/2007	Hargreaves		D683,064 S	5/2013	Tuck	
D544,985 S	6/2007	Hargreaves		8,505,224 B2	8/2013	Huang	
D544,987 S	6/2007	Hargreaves		D689,238 S	9/2013	Halsey	
D544,994 S	6/2007	Hargreaves		D690,875 S	10/2013	McKenzie	
D544,995 S *	6/2007	Hargreaves	D26/118	D693,959 S *	11/2013	Boyer	D26/118
D545,460 S	6/2007	Mason, II		D697,663 S	1/2014	Speier	
D545,484 S *	6/2007	Hargreaves	D26/118	D698,074 S	1/2014	Hargreaves	
D545,485 S *	6/2007	Hargreaves	D26/118	D698,075 S	1/2014	Klus	
D545,990 S	7/2007	Hargreaves		D698,986 S *	2/2014	Reynolds	D26/118
D545,994 S	7/2007	Hargreaves		D698,987 S	2/2014	Stanley	
D545,996 S	7/2007	Hargreaves		D699,386 S	2/2014	Park	
D549,869 S	8/2007	Ward		D702,827 S	4/2014	Mase	
7,296,914 B1	11/2007	Russello		8,702,283 B2	4/2014	Bradley, Jr.	
7,360,927 B2	4/2008	Oka		D705,474 S	5/2014	Philips	
D569,024 S	5/2008	Redfern		D705,974 S	5/2014	Blessitt	
D572,858 S	7/2008	Santoro		8,723,086 B2	5/2014	McMahan	
7,445,363 B2	11/2008	Vanden Eynden		D707,385 S	6/2014	Wardenburg	
7,524,090 B2	4/2009	Hargreaves		D708,390 S	7/2014	Roos	
7,534,011 B2	5/2009	Townesley		D710,528 S	8/2014	Wardenburg	
D595,894 S	7/2009	Verfuert		8,801,235 B2	8/2014	Yurich	
D602,625 S	10/2009	Santoro		D713,953 S	9/2014	Jepson	
D603,087 S	10/2009	Mo et al.		D714,988 S	10/2014	Park	
7,617,057 B2	11/2009	May		D715,994 S	10/2014	Klus	
D605,342 S	12/2009	Chung		D717,487 S	11/2014	Guzzini	
D608,490 S	1/2010	Chung		D717,636 S	11/2014	Stanley	
7,641,367 B2	1/2010	Hargreaves et al.		D720,488 S	12/2014	Toyohisa	
7,654,702 B1	2/2010	Ding		D720,505 S	12/2014	Kersten	
D613,900 S	4/2010	Hargreaves		8,905,575 B2 *	12/2014	Durkee	F21V 7/0008 362/218
D614,801 S *	4/2010	Collins	D26/118	D720,876 S	1/2015	Haverfield	
7,722,228 B2	5/2010	Broer		D721,844 S	1/2015	Lay	
D617,028 S	6/2010	Verfuert		D722,654 S	2/2015	Martone	
D620,190 S	7/2010	Chung		D725,819 S	3/2015	Reynolds	
7,771,086 B2	8/2010	Goverde		D725,820 S	3/2015	Hargreaves	
D628,335 S	11/2010	Hyland		8,967,821 B2	3/2015	Pickard	
7,854,534 B2	12/2010	Liu		D726,359 S	4/2015	Grigore	
D632,419 S	2/2011	Ng		8,998,473 B1	4/2015	Anderson	
				9,016,892 B1	4/2015	Scribante	
				9,016,907 B2	4/2015	Stanley	
				D728,848 S	5/2015	Reyes	

(56)

References Cited

U.S. PATENT DOCUMENTS

D729,435 S 5/2015 Arndt
D730,556 S 5/2015 Toyohisa
D731,103 S 6/2015 Wilke
D731,701 S * 6/2015 Hargreaves D26/118
D732,233 S 6/2015 Reynolds
D732,234 S 6/2015 Rashidi Doust
D732,235 S * 6/2015 Reynolds D26/118
D732,236 S * 6/2015 Reynolds D26/118
D733,347 S 6/2015 Dungan
D733,952 S 7/2015 Lay
D733,960 S 7/2015 Howe
D734,534 S 7/2015 Howe
D735,391 S 7/2015 Blessitt
D735,401 S 7/2015 Clements
D736,450 S * 8/2015 Reynolds D26/118
D737,498 S 8/2015 Stanley
9,110,209 B2 8/2015 Blessitt
D738,031 S 9/2015 Martins
D739,595 S 9/2015 Reynolds
9,127,826 B2 9/2015 Boyer
D740,486 S * 10/2015 Stanley D26/118
D740,996 S 10/2015 Tragatschnig
D745,993 S 12/2015 Reynolds
D747,029 S * 1/2016 Reynolds D26/118
D747,538 S 1/2016 Hargreaves
D747,825 S 1/2016 Reynolds
D748,849 S * 2/2016 Stanley D26/118
D749,773 S 2/2016 Waible
D750,312 S 2/2016 Reynolds
D750,313 S 2/2016 Reynolds
D750,316 S * 2/2016 Reynolds D26/118
9,255,690 B2 2/2016 Dimitriadis
D750,831 S 3/2016 Clements
D751,244 S * 3/2016 Reynolds D26/118
D751,245 S 3/2016 Stanley
D751,247 S * 3/2016 Reynolds D26/118
D756,016 S 5/2016 Hargreaves
D756,023 S 5/2016 Hoffer
D756,026 S 5/2016 Reynolds
D757,323 S 5/2016 Reynolds
D757,326 S 5/2016 Reynolds
D757,346 S 5/2016 Stanley
9,335,038 B2 5/2016 Stanley
9,366,947 B2 6/2016 Miyata
2002/0073285 A1 6/2002 Butterworth
2002/0141195 A1 10/2002 Peter
2003/0031011 A1 2/2003 Miller
2003/0191783 A1 10/2003 Wolczko
2004/0240214 A1 12/2004 Whitlow
2005/0117333 A1 6/2005 Yoshida
2005/0160481 A1 7/2005 Todd
2005/0233691 A1 10/2005 Horton
2006/0231081 A1 10/2006 Kirakosyan
2006/0232984 A1 10/2006 Schuknecht
2006/0282457 A1 12/2006 Williams
2007/0051321 A1 3/2007 Chang
2007/0070633 A1 3/2007 Eynden
2007/0228993 A1 10/2007 Stuer
2007/0246631 A1 10/2007 Brown
2007/0282806 A1 12/2007 Hoffman
2008/0059799 A1 3/2008 Scarlata
2008/0117617 A1 5/2008 Hargreaves
2008/0205030 A1 8/2008 Hargreaves
2008/0205071 A1 8/2008 Townsley
2008/0212326 A1 9/2008 Chon
2008/0278950 A1 11/2008 Pickard et al.
2008/0278957 A1 11/2008 Pickard
2009/0116250 A1 5/2009 Hargreaves
2009/0231840 A1 9/2009 Boehme
2009/0262540 A1 10/2009 Hargreaves et al.
2009/0276478 A1 11/2009 Soman
2009/0310373 A1 12/2009 Burkhauser
2009/0316404 A1 12/2009 Mo
2009/0323335 A1 12/2009 Yang
2010/0214789 A1 8/2010 Hawkes

2010/0238661 A1 9/2010 Pfund
2010/0277908 A1 11/2010 Hu
2010/0277929 A1 11/2010 Hargreaves
2010/0302768 A1 12/2010 Collins
2011/0169412 A1 7/2011 Yurich
2011/0203096 A1 8/2011 Hargreaves
2011/0259665 A1 10/2011 Morgan
2012/0092859 A1 4/2012 Gregoris
2012/0212883 A1 8/2012 Hargreaves
2012/0230035 A1 9/2012 Bradley, Jr.
2013/0083539 A1 4/2013 Dimitriadis
2013/0155685 A1 6/2013 Stanley
2013/0242573 A1 9/2013 Petrsoiki
2013/0250567 A1 9/2013 Edmond
2014/0378283 A1 12/2014 Qiu
2015/0023022 A1 1/2015 Stanley
2015/0098215 A1 4/2015 Torabifard
2015/0252992 A1 9/2015 Stanley
2015/0252993 A1 9/2015 Stanley
2015/0252994 A1 9/2015 Stanley

FOREIGN PATENT DOCUMENTS

EP 0325003 A1 7/1989
EP 0440274 A1 8/1991
WO 02063210 A2 8/2002
WO 2008018000 A1 2/2008
WO 2009096775 A2 8/2009
WO 2011119451 A1 9/2011
WO 2015009333 1/2015

OTHER PUBLICATIONS

Apollo Horticulture GLRCTAC 6" Air Cool Tube Grow Light Deluxe Glass Cylinder with Hood Reflector, image post date Oct. 15, 2010, site visited Oct. 3, 2014, (online), <http://www.amazon.com/apollo-horticulture-glrectac-cylinder-reflector/dp/b003qkvv04/ref=pd_sbs_lg_5?ie=utf8&refrid=1y9v9qhh4n5vncjtmftr>.
Apollo Horticulture GLRLS24 6" Air Cooled Hydroponic Grow Light Glass Reflector Hood, image post date Oct. 15, 2010, site visited Oct. 3, 2014, (online), <http://www.amazon.com/apollo-horticulture-GLRLS24-hydroponic-reflector/dp/B00BMVK8HG/ref=cm_cd_ql_qh_dp_i>.
Adjustable Reflector, image post date Apr. 23, 2012, site visited Sep. 23, 2015, http://web.archive.org/web/2012043260757/http://hydroponics-products.en.alibaba.com/product/519225678-213056444/adjustable_reflector_grow_light_hydroponics_greenhouse_horticulture_reflector_hood.html.
Agrotech Magnum Reflector, image post date Feb. 5, 2012, site visited Oct. 31, 2014, www.hydroponics.net/136580.
Cree CR22, image post date Apr. 28, 2011, site visited Nov. 15, 2014, <http://ledsmagazine.com/content/dam/leds/migrated/objects/news/8/4/19/cree204272011.jpg>.
ZR series High Efficacy Troffer, image post date Apr. 13, 2012, site visited Oct. 31, 2014, www.cree.com/lighting/products.
Grow Lights Home Depot: Find many types of grow lights for your plant, published Dec. 22, 2012, online. Site visited Jun. 25, 2014. <http://besthomedecor.com/gardening-dcor/grow-lights-home-depot-few-things-to-consider-when-buying-grow-lighting-plants-online.html>.
LED Grow Light Comparison Test Review, Youtube.com, published Jun. 29, 2012, online. Site visited Jun. 25, 2014. www.youtube.com/watch?v=f-8oy0qbgrs.
Illuminator Pro-Series Hybrid 350W, wordpress.com, published Dec. 22, 2010, online, site visited Jun. 25, 2014. <http://growsetup.wordpress.com/category/grow-lights/>.
California Lightworks New SolarStorm 440W LED Grow Light with UVB, hydrobuilder.com online. Site visited Jun. 25, 2014. http://hydrobuilder.com/solarstorm-440w-led-grow-light-with-uvb.html?dzid=strands_CLW-SS-440.
2013 Sunlight Supply Cataog, Issuu.com, published Aug. 1, 2013, online. Site visited Feb. 2, 2015. http://issuu.com/sunlightsupply/docs/2013_sunlightproductcatalog/49.

(56)

References Cited

OTHER PUBLICATIONS

Pages 29 and 54 from 2014-2015 dealer catalog showing and describing Super Sun DE reflector published by Sunlight Supply, Inc. 2014.

Dominator XXXL Non AC Reflector pack of 3 Spec Sheet, GreenTreesHydroponics.com, date available Mar. 12, 2014, online. Site visited Feb. 3, 2015, <https://www.hydroponics.net/i/141477>.

Low Rider Air-Cooled Reflector—TinEye, image post date Oct. 11, 2012, site visited Oct. 1, 2015, www.tineye.com/search/1b0e187c5ed9e4e9cfb55d0472271385a2c0e88/?pluginver.

OG Air Cooled Parabolic Reflector Only—Make the Most of Your Grow Light, GroWell Hydroponics, <http://www.growell.co.uk/og-air-cooled-parabolic-reflector-only.html>, pp. 1-2, accessed Aug. 26, 2014.

Air Resistance: Distinguishing Between Laminar and Turbulent Flow, www.docstoc.com, Dec. 29, 2010, p. 1-6.

Sun Systems LEC 630 Light Emitting Ceramic Fixture, Spec Sheet for 906217—Sun System LEC 630 120 Volt w/ 3100 K Lamps, www.sunlightsupply.com/shop/bycategory/led-lighting/sun-system-lec-630-light-emitting-ceramic-fixture, online, updated Feb. 9, 2015. Site visited Mar. 30, 2015, p. 1.

Mohri, Mineko, International Preliminary Report on Patentability for PCT/US2014/014959, Jan. 19, 2016.

A3V Reflector, Titaness Light Shop, www.titanesslightshop.com/products-page/reflectors/a3v-reflector, online. Site visited Jan. 14, 2015.

G2V Grow Light Reflector, Titaness Light Shop, www.titanesslightshop.com/products-page/reflectors/g2v-grow-light-reflector, online. Site visited Jan. 14, 2015.

1000 Watt Galaxy Grow Amp Double Ended Grow Light Packages, image post date Jan. 30, 2014, site visited Jan. 8, 2016, <<http://www.ehydroponics.com/100-watt-galaxy-grow-amp-double-ended-grow-light-package.html>>.

2009-10-watt-light-set—TinEye, image post date May 23, 2012, site visited Jul. 8, 2016, <<https://www.tineye.com/search/2de39cf51f7a031139a80ce555e2f30d0abd5216/>>.

Square 10 Watt LED Grow Light, image post date Aug. 1, 2011, site visited Jul. 8, 2016, <<http://www.dhgate.com/store/product/hydroponic-vegetable-10-watt-led-grow-light/216755031.html>>.

Sun System 630 Ceramic Metal Halide 120v Specifications, GrowersHouse.com, update on Sep. 9, 2014, Online. Site visited Feb. 3, 2015. <http://growershouse.com/aitdownloadablefiles/download/aitfile/aitfile_id/583/>.

Growlite HDE 600W-1000W Double Ended Lamp Concealed Vacuum Airflow Technology, Indoor Grow Science, site visited Aug. 3, 2016, <<http://www.indoorgrowscience.net/downloads/specs/hde.pdf>>.

* cited by examiner

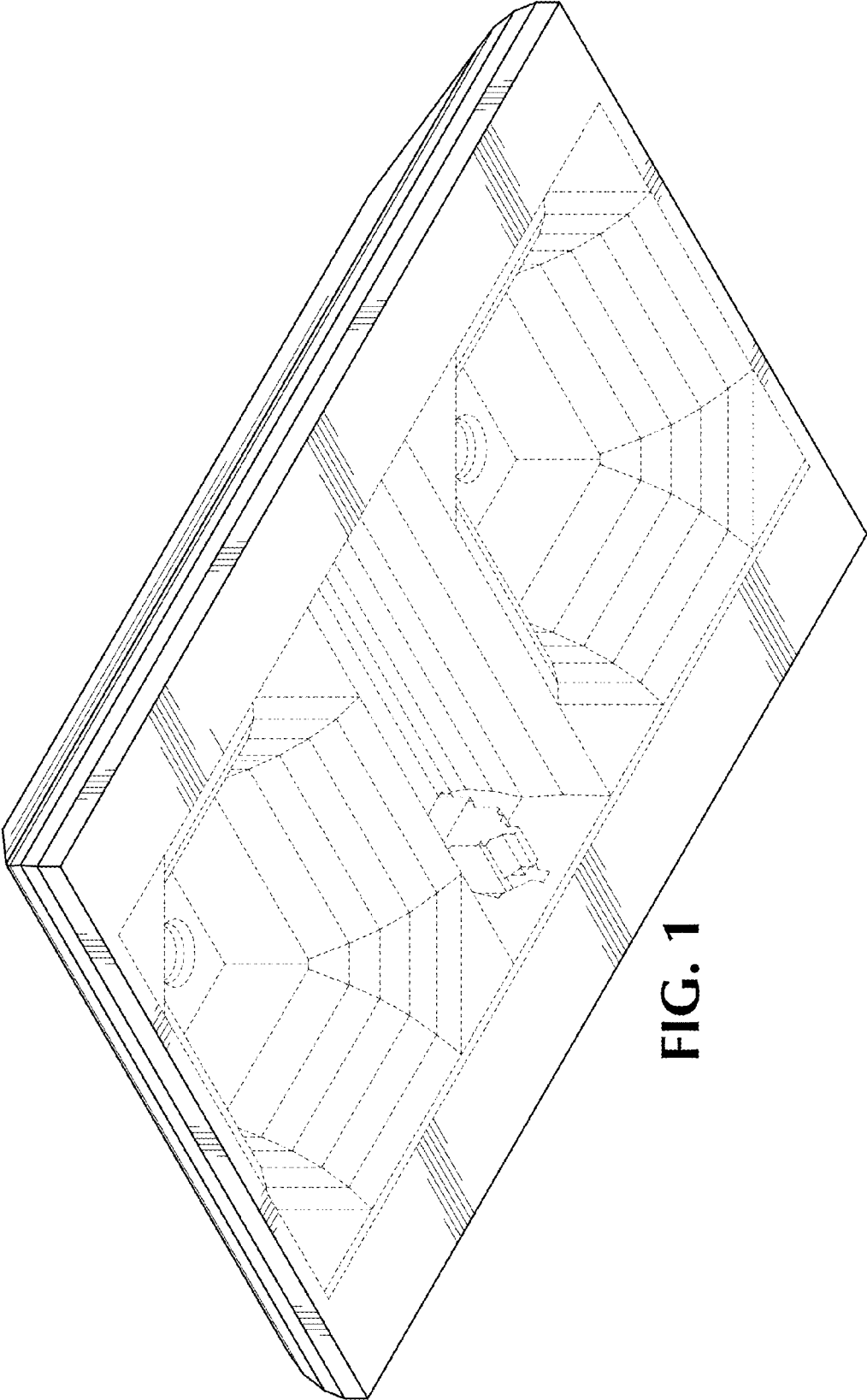

FIG. 1

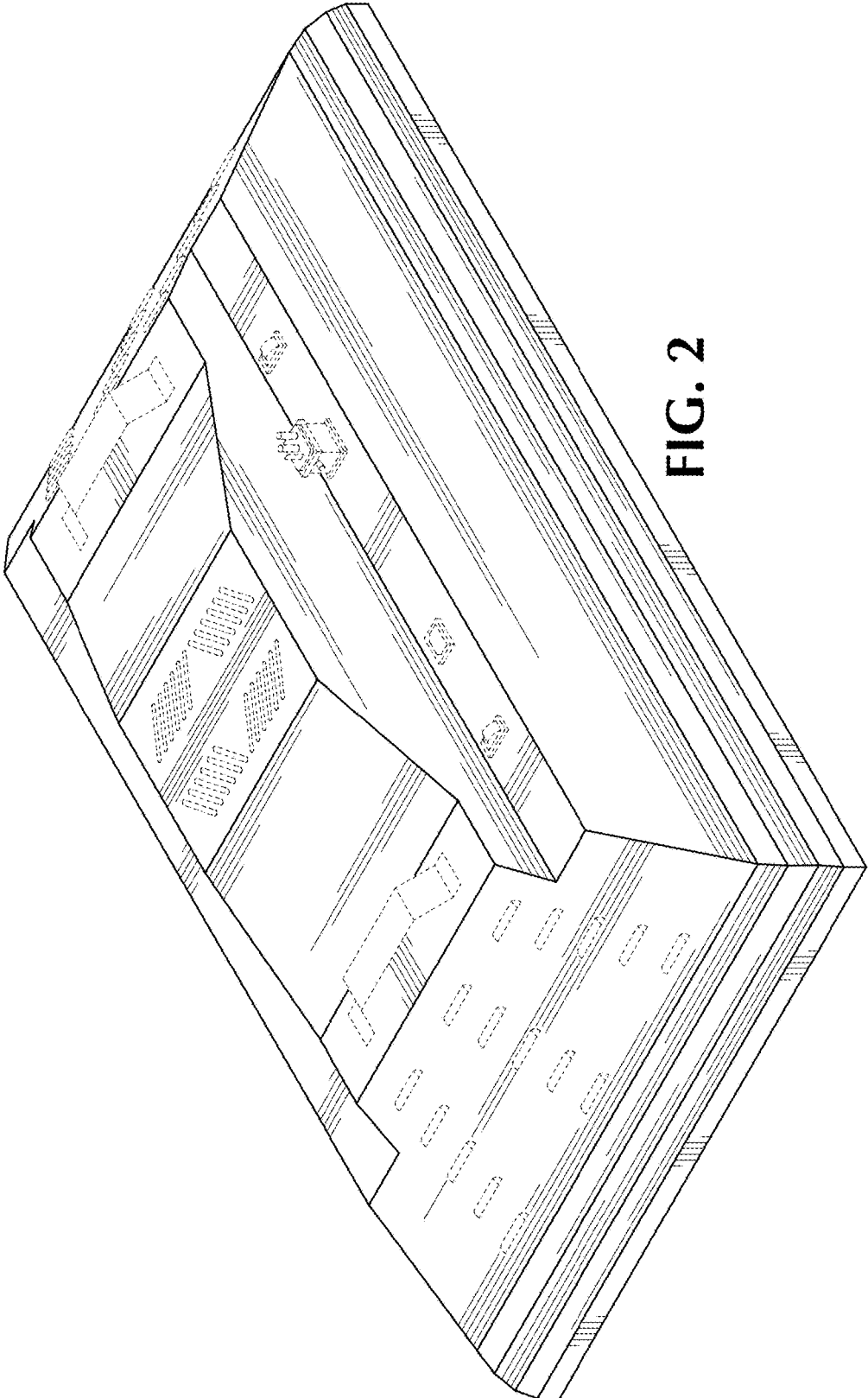

FIG. 2

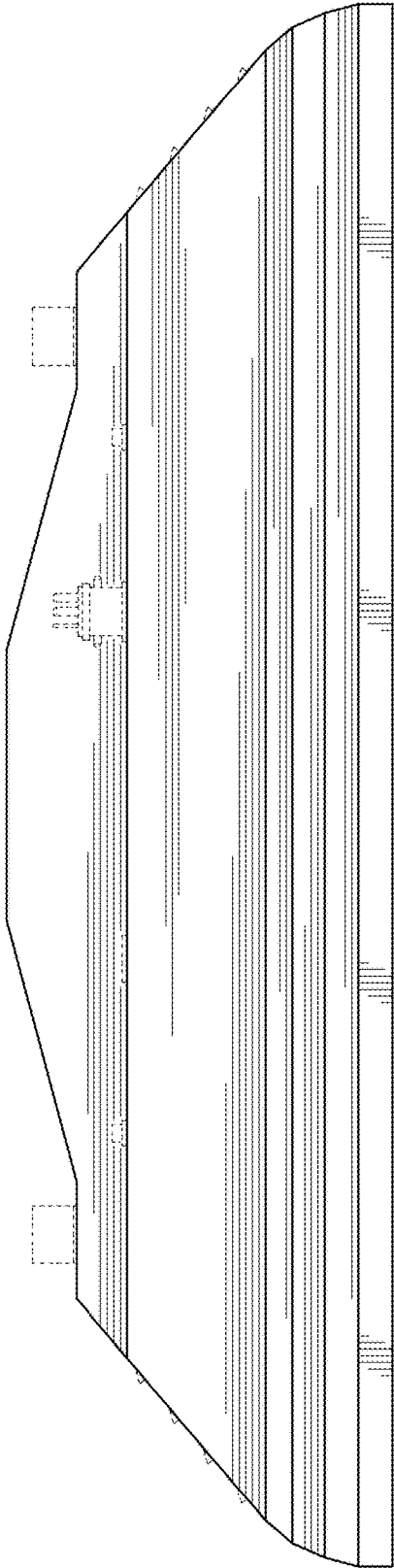

FIG. 3

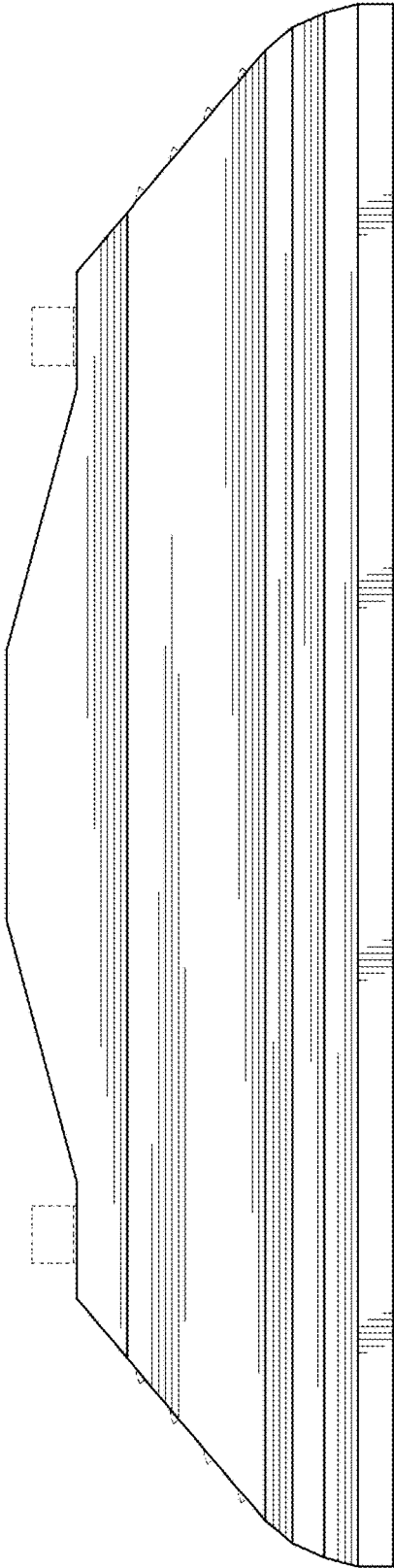

FIG. 4

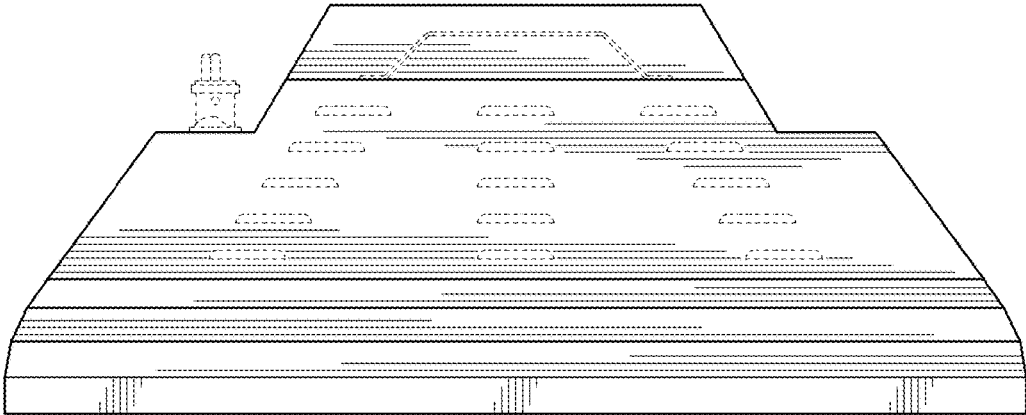

FIG. 5

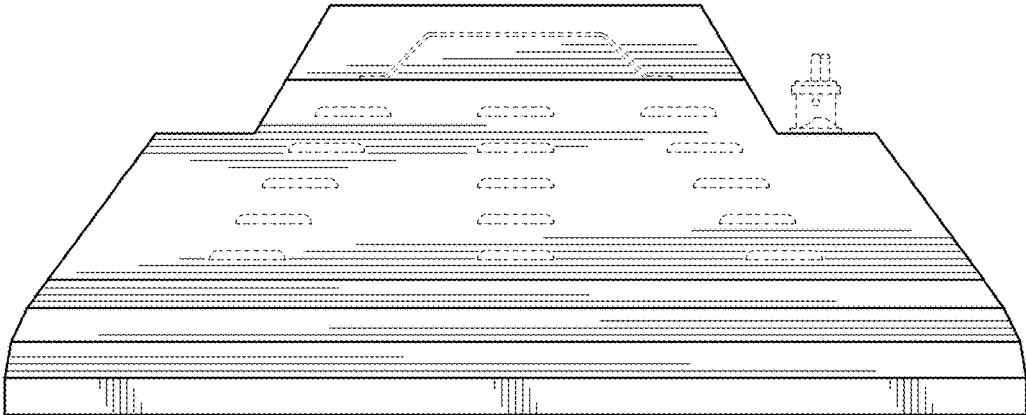

FIG. 6

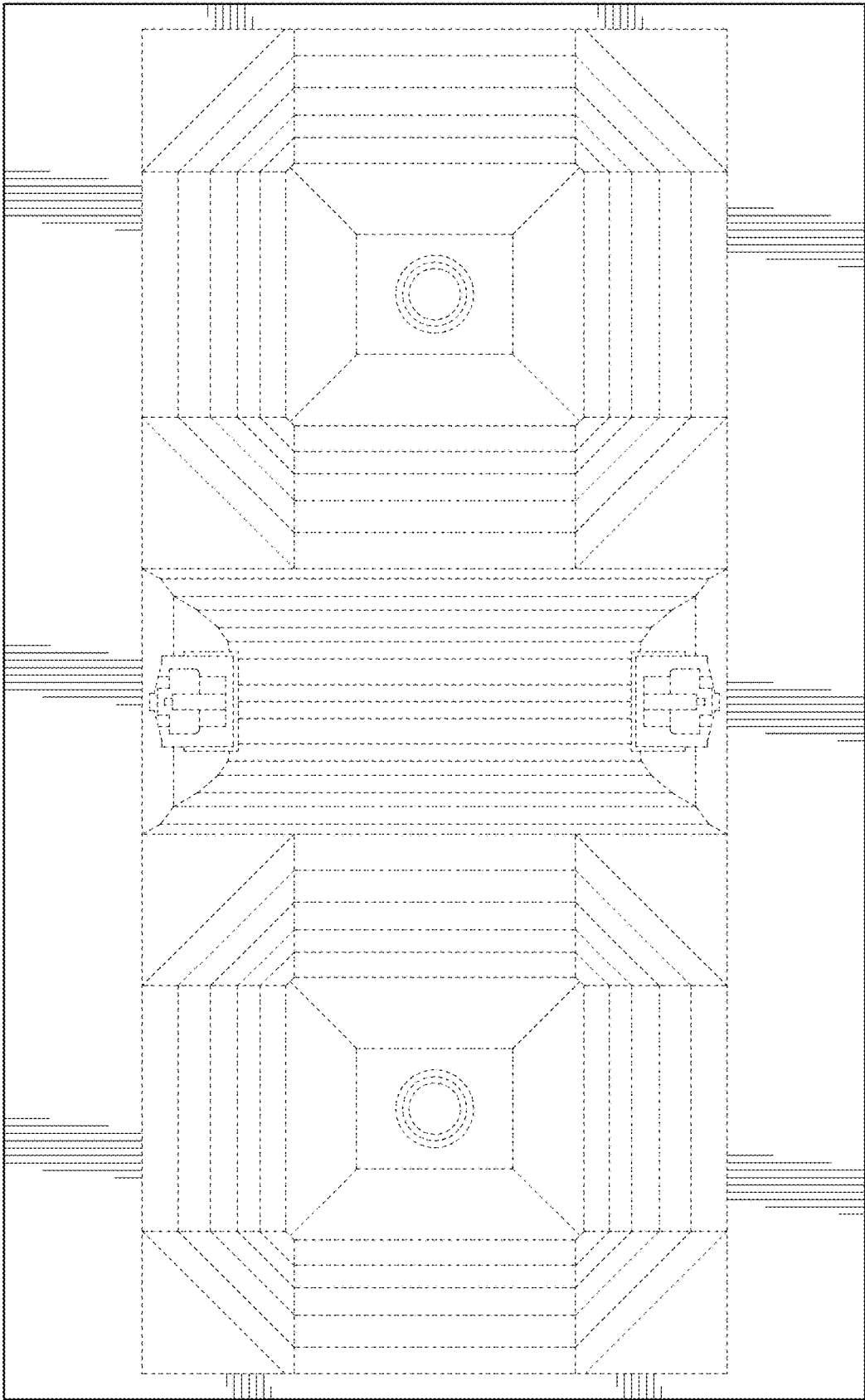

FIG. 7

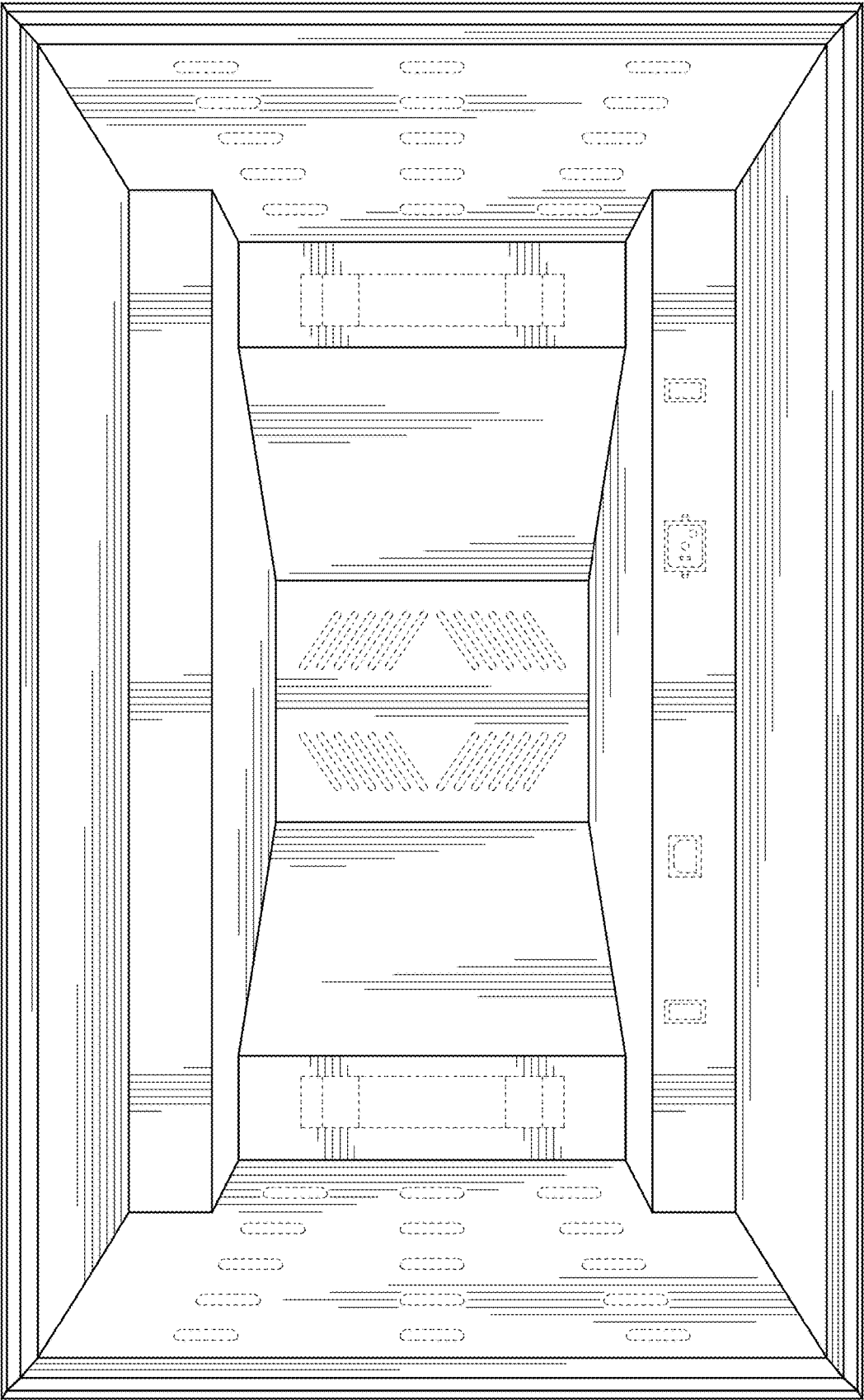

FIG. 8