



US00D385272S

# United States Patent [19]

[11] Patent Number: Des. 385,272

Jensen et al.

[45] Date of Patent: \*\*Oct. 21, 1997

## [54] COMMUNICATION HEADSET

5,210,792	5/1993	Kajihara .....	379/430
5,260,997	11/1993	Gatley et al. ....	379/430
5,450,496	9/1995	Burris et al. ....	381/183

[75] Inventors: **Wolfgang W. Jensen**, Aptos; **David V. Hoenig**, Los Gatos, both of Calif.

[73] Assignee: **ACS Wireless, Inc.**, Scotts Valley, Calif.

[\*\*] Term: **14 Years**

[21] Appl. No.: **56,068**

[22] Filed: **Jun. 21, 1996**

### Related U.S. Application Data

[63] Continuation-in-part of Ser. No. 590,744, Jan. 24, 1996.

[51] LOC (6) Cl. .... **14-03**

[52] U.S. Cl. .... **D14/142**

[58] Field of Search ..... D14/192, 223, D14/206, 140, 142, 249, 205, 148, 147, 240; 379/419, 420, 428, 440, 430, 433; 455/89, 90; 381/183

### [56] References Cited

#### U.S. PATENT DOCUMENTS

D. 233,444	10/1974	Christian et al. ....	D14/206
D. 326,653	6/1992	Hino .....	D14/192
D. 339,355	9/1993	Burris et al. ....	D14/206 X
D. 366,486	1/1996	Runquist et al. ....	D14/206
D. 371,133	6/1996	Andrea .....	D14/206
4,020,297	4/1977	Brodie .....	379/430
4,273,969	6/1981	Foley et al. ....	379/430
4,893,344	1/1990	Traardh et al. ....	379/430 X

### OTHER PUBLICATIONS

U.S. Application No. 08/590,744, filed Jan. 24, 1996, entitled "Communications Headset," by Wolfgang W. Jensen and David V. Hoenig.  
Hello Direct Spring 1994, p. 9, Solo Pro At Top Right.  
BA Pargh 1992 Spring Summer Catalog, p. 333, Mirage Modular Headset, 2nd From Bottom Right.

*Primary Examiner*—Jeffrey Asch  
*Attorney, Agent, or Firm*—Limbach & Limbach L.L.P.

### [57] CLAIM

The ornamental design for a communication headset, as shown and described.

### DESCRIPTION

FIG. 1 is a perspective view of a communications headset showing our design;  
FIG. 2 is a side elevational view thereof;  
FIG. 3 is a top plan view thereof;  
FIG. 4 is a bottom plan view thereof;  
FIG. 5 is a front elevational view thereof;  
FIG. 6 is a rear elevational view thereof; and,  
FIG. 7 is an opposite side elevational view thereof.  
The perspective view of FIG. 1 is an alternative position for use. The broken line showings of FIG. 1, 2, 5, 6, and 7 are for illustrative purposes only and form no part of the claimed design.

1 Claim, 4 Drawing Sheets

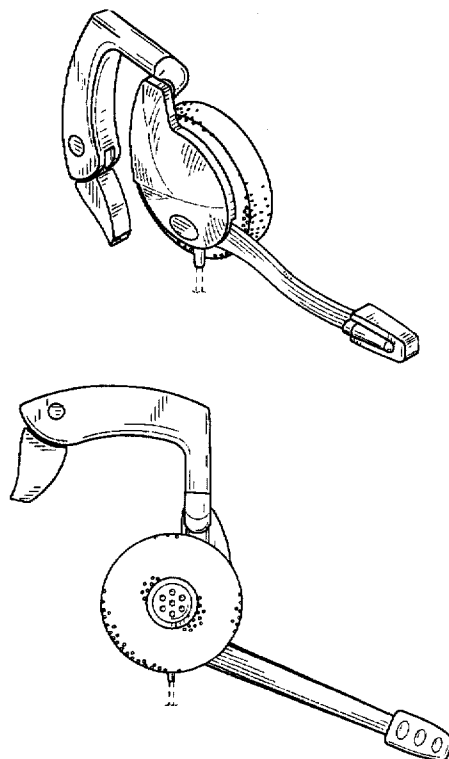

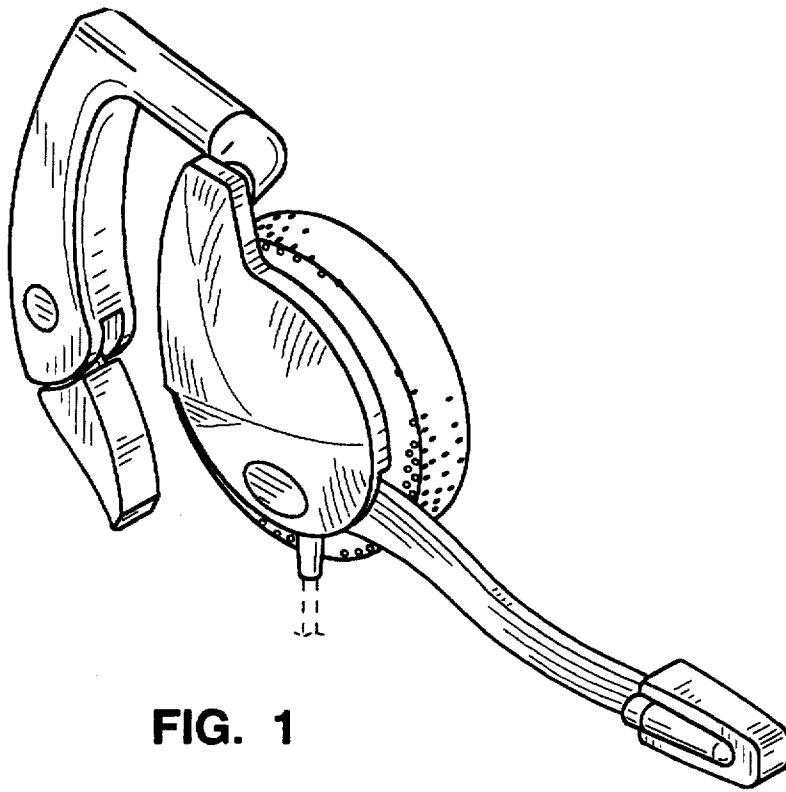

FIG. 1

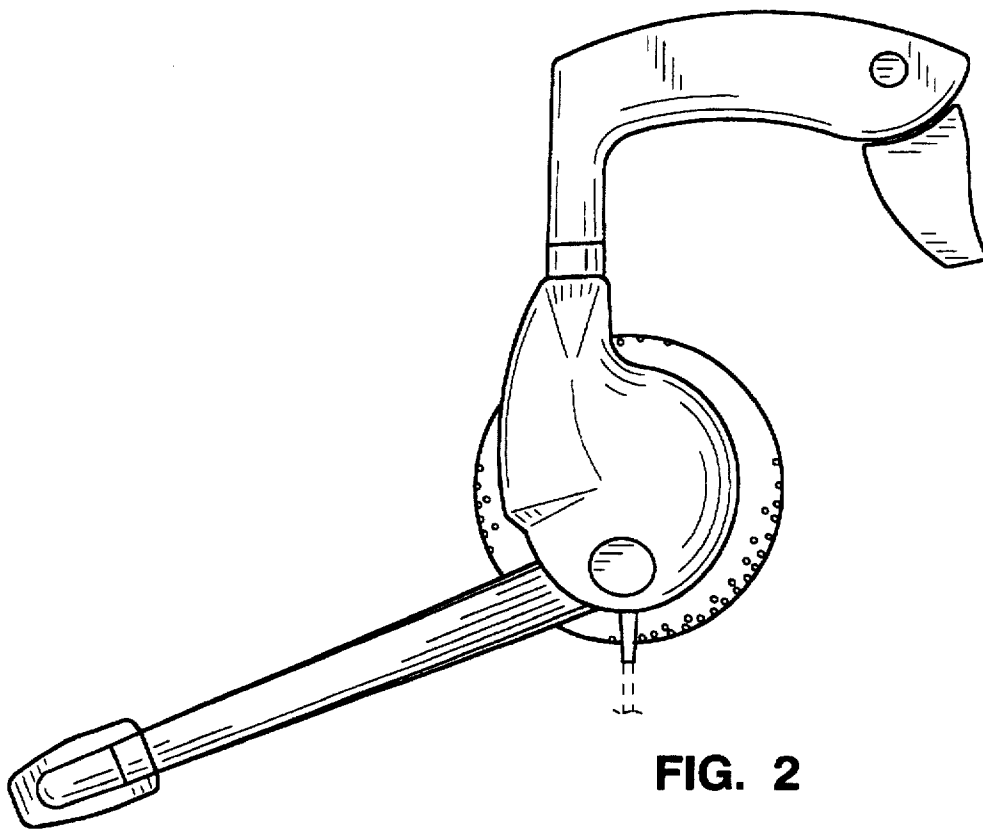

FIG. 2

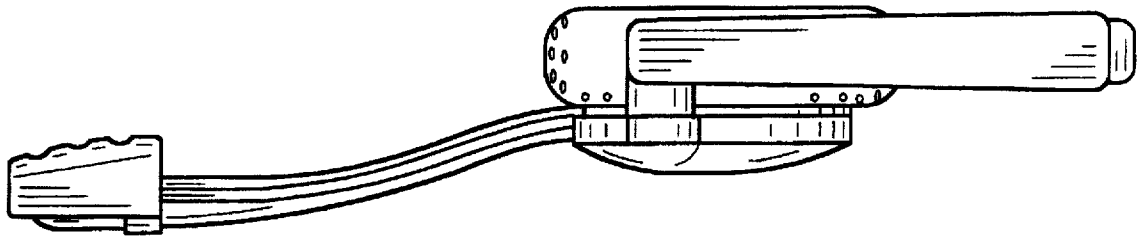

FIG. 3

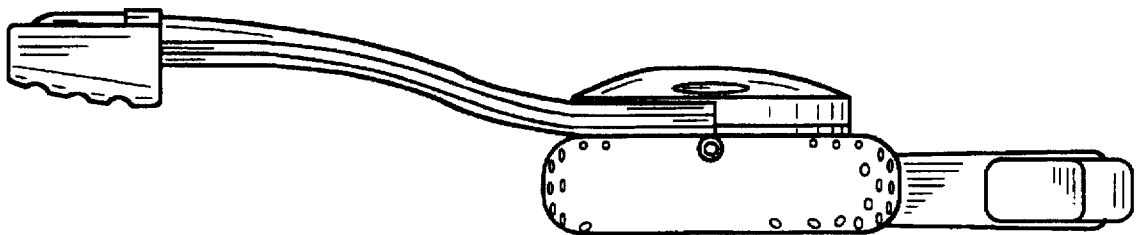

FIG. 4

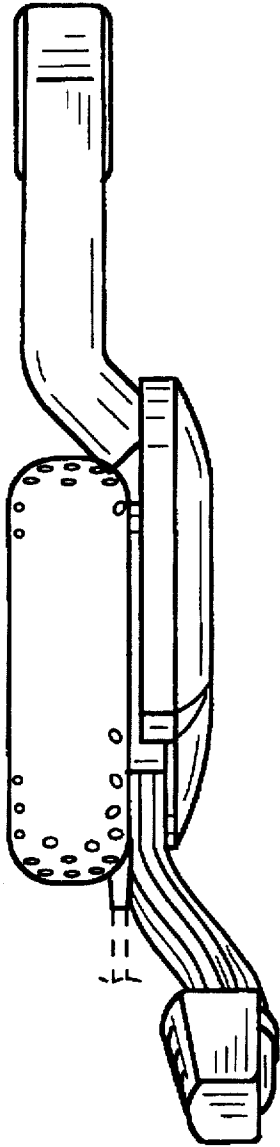

FIG. 5

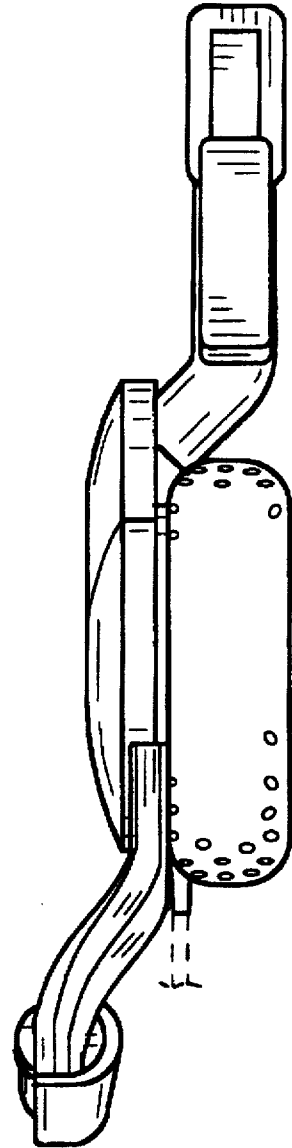

FIG. 6

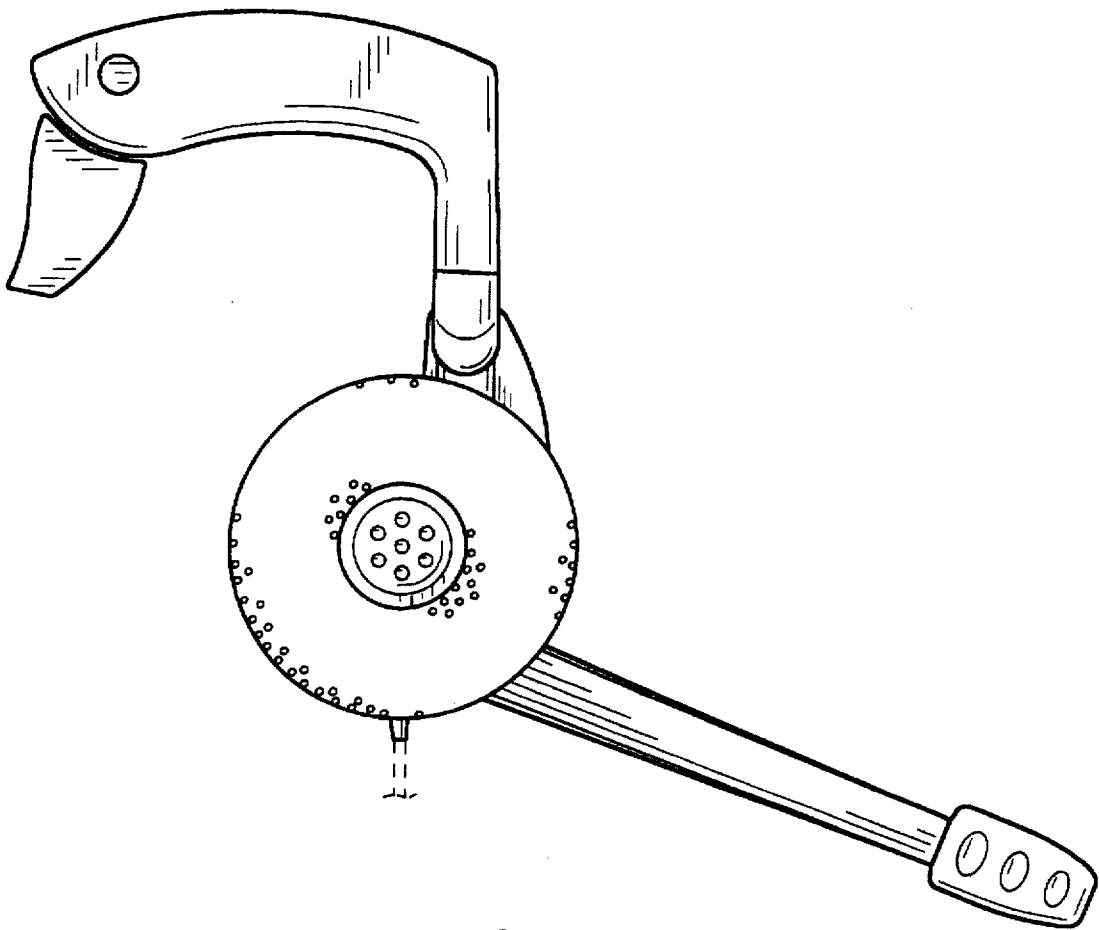

FIG. 7