



US00D357554S

United States Patent [19]

[11] Patent Number: **Des. 357,554**

Garneau

[45] Date of Patent: **** Apr. 18, 1995**

[54] **CYCLIST'S HELMET**

D. 339,427 9/1993 Gentes D29/12

[75] Inventor: **Louis Garneau,**
St-Augustin-De-Demaures, Canada

OTHER PUBLICATIONS

Bicycling, Jul. 1988, p. 119 "Giant AT750 helmet".
American Bicyclist & Motorocyclist, Mar. 1985, p. 51
"Bell helmet".

[73] Assignee: **Vetements Louis Garneau Inc.,**
Québec, Canada

Primary Examiner—Ruth McInroy
Attorney, Agent, or Firm—Collard & Roe

[**] Term: **14 Years**

[21] Appl. No.: **869,369**

[57] **CLAIM**

The ornamental design for a cyclist's helmet, as shown and described.

[22] Filed: **Apr. 15, 1992**

[52] U.S. Cl. **D29/102**

[58] Field of Search D29/12-18;
2/410-412, 414-418, 422-425

DESCRIPTION

[56] **References Cited**

U.S. PATENT DOCUMENTS

- D. 299,978 2/1989 Chiarella D29/12
- D. 303,851 10/1989 Gentes D29/12
- D. 309,961 8/1990 Bobnck D29/12
- D. 319,112 8/1991 Broeisma D29/12

FIG. 1 is a top, front and side perspective view of a cyclists helmet, showing my new design;
FIG. 2 is a right side elevational view thereof;
FIG. 3 is a front elevational view thereof;
FIG. 4 is a rear elevational view thereof;
FIG. 5 is a top plan view thereof; and,
FIG. 6 is a bottom plan view thereof.

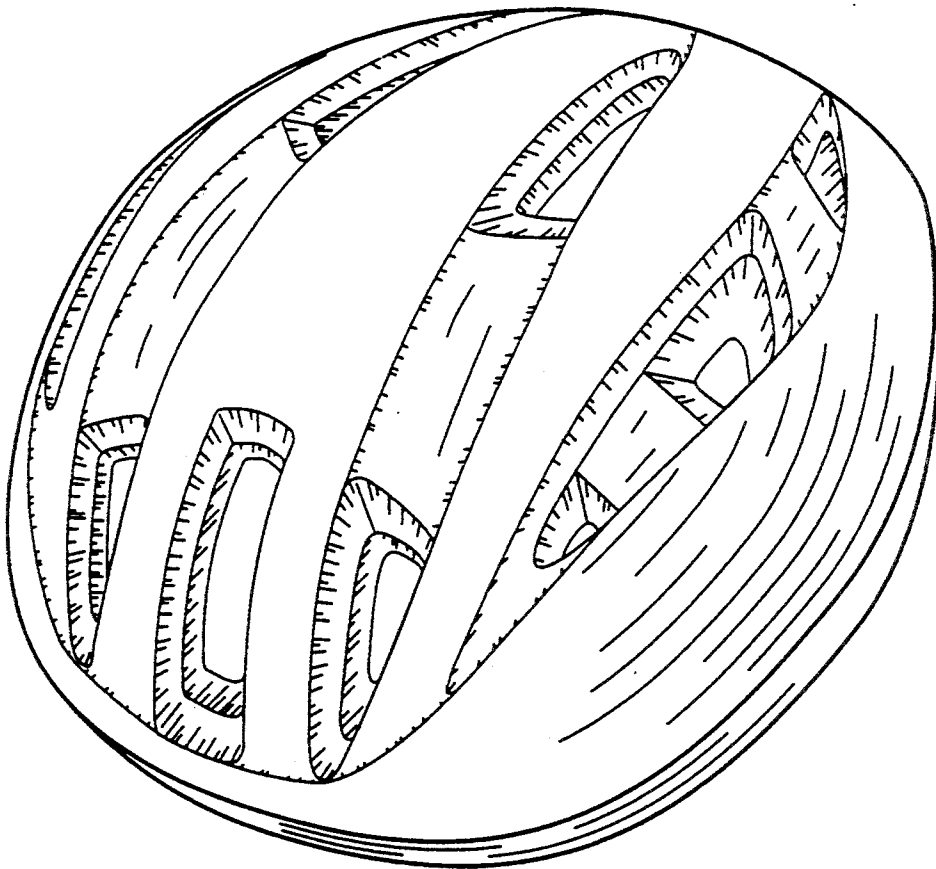

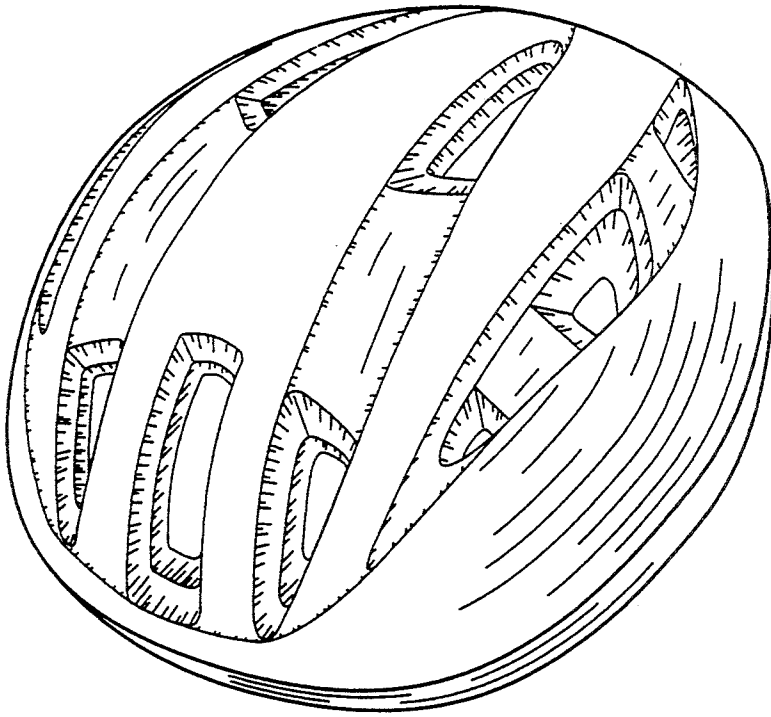

Fig.1

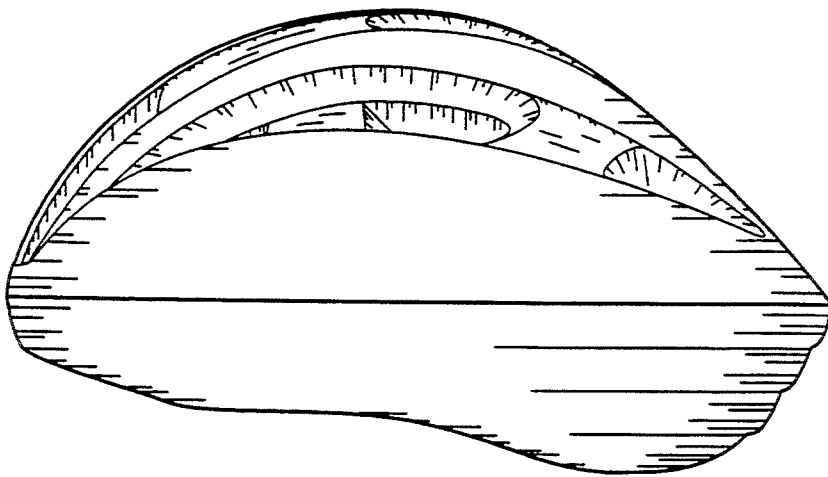

Fig.2

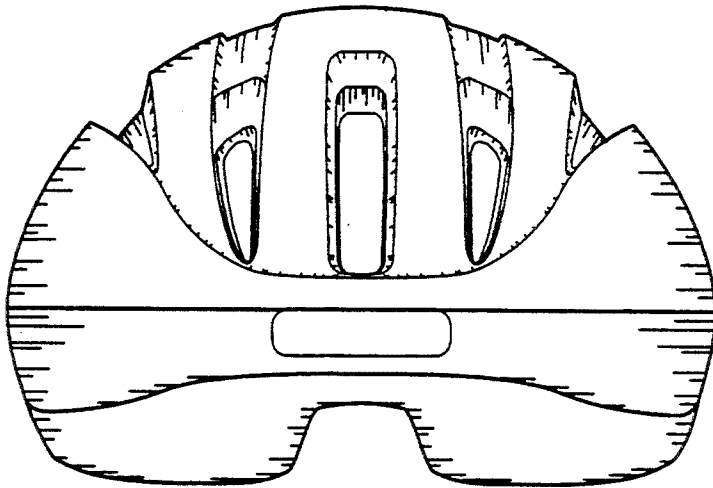

Fig.3

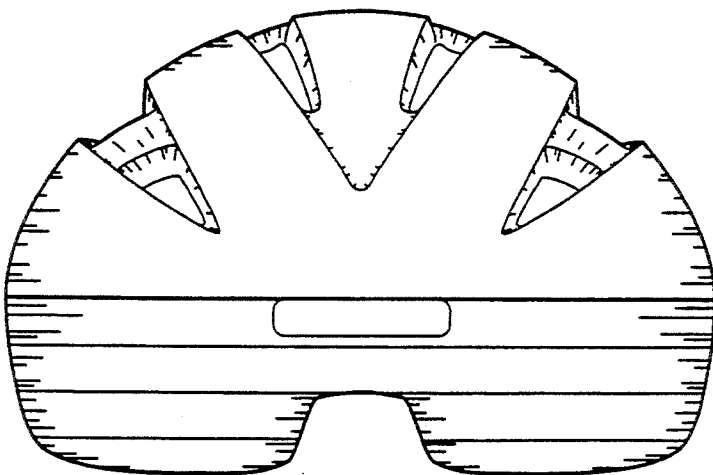

Fig.4

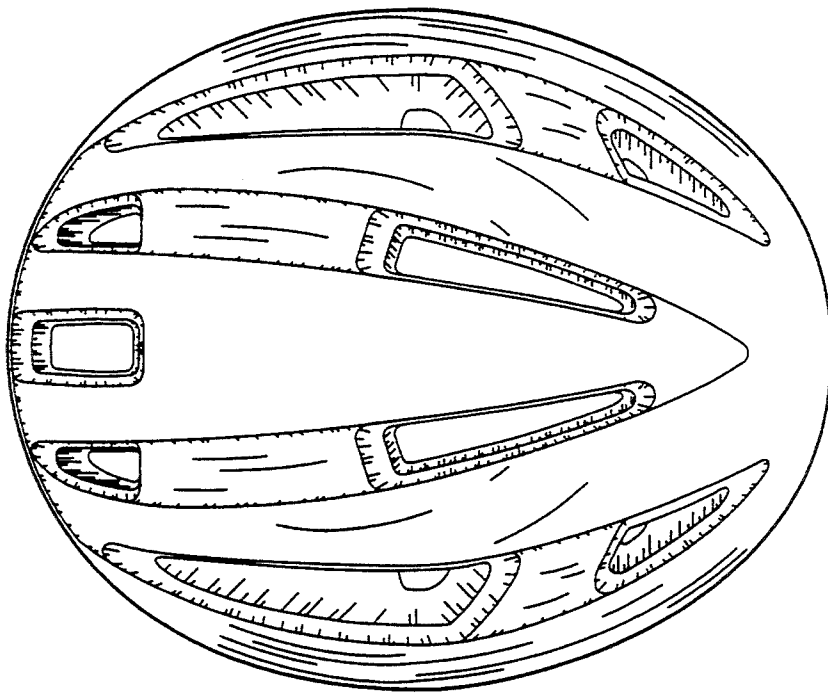

Fig.5

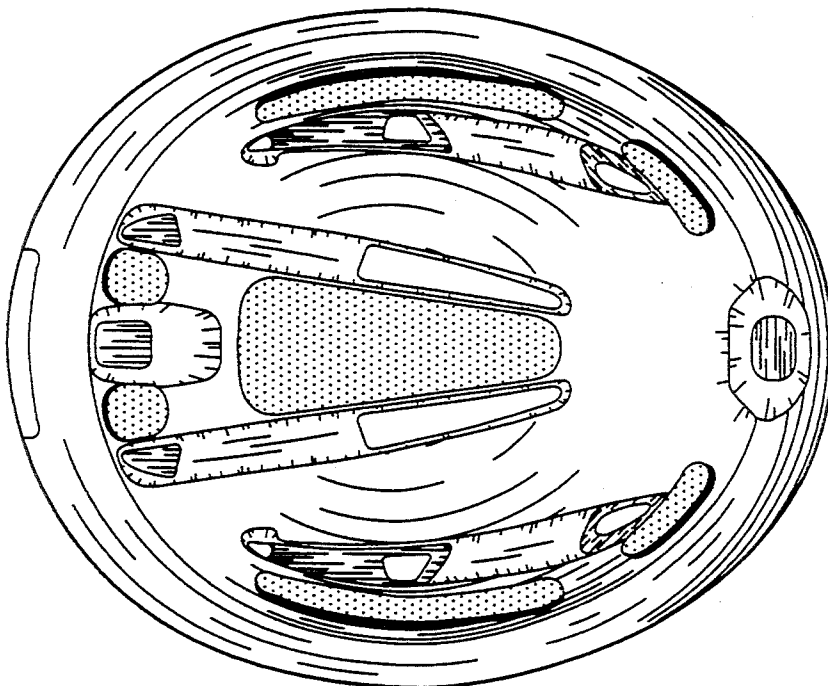

Fig.6