



US00D880591S

(12) **United States Design Patent** (10) **Patent No.:** **US D880,591 S**
Lee et al. (45) **Date of Patent:** **** Apr. 7, 2020**

(54) **DIGITAL SIGNAGE**

(56) **References Cited**

(71) Applicant: **LG ELECTRONICS INC.**, Seoul (KR)
(72) Inventors: **Yoonkyeong Lee**, Seoul (KR); **Yongho Lee**, Seoul (KR); **Jaewon Lim**, Seoul (KR)
(73) Assignee: **LG ELECTRONICS INC.**, Seoul (KR)
(**) Term: **15 Years**
(21) Appl. No.: **35/505,947**
(22) Filed: **Apr. 27, 2018**

U.S. PATENT DOCUMENTS

D279,201 S *	6/1985	Shuman	D20/10
D417,468 S *	12/1999	Van Genechten	D20/10
D450,776 S *	11/2001	Albrecht	D20/10
D483,575 S *	12/2003	Chan	D6/310
D509,543 S *	9/2005	Hillstrom	D20/41
D662,329 S *	6/2012	Arko	D6/332
D708,459 S *	7/2014	Heirakuji	D6/675
D723,026 S *	2/2015	Birgeoglu	D14/307
D790,232 S *	6/2017	Santos	D6/300
D790,457 S *	6/2017	Vargas	D13/108
D807,054 S *	1/2018	Gilad	D6/300
D816,627 S *	5/2018	Kim	D14/126
D852,273 S *	6/2019	Lim	D20/39
D852,274 S *	6/2019	Lim	D20/39

(80) **Hague Agreement Data**
Int. Filing Date: **Apr. 27, 2018**
Int. Reg. No.: **DM/100972**
Int. Reg. Date: **Apr. 27, 2018**
Int. Reg. Pub. Date: **Nov. 2, 2018**

OTHER PUBLICATIONS

The Korea Herald. Transparent screen by Lim Jeong-yeo. Feb. 6, 2019. <http://www.koreaherald.com/view.php?ud=20190206000108> (Year: 2019).*

* cited by examiner

Primary Examiner — Darcey E Gottschalk
(74) *Attorney, Agent, or Firm* — Birch, Stewart, Kolasch & Birch, LLP

(30) **Foreign Application Priority Data**
Oct. 27, 2017 (KR) 30-2017-0050043

(57) **CLAIM**

The ornamental design for a digital signage, as shown and described.

(51) **LOC (12) Cl.** **20-03**
(52) **U.S. Cl.**

DESCRIPTION

USPC **D20/39**
(58) **Field of Classification Search**
USPC D6/300, 310, 332; D10/113.4; D19/113; D20/9, 10, 15, 19, 27, 39, 41-43, 99; D14/126, 300, 305, 307, 314-316, 335, D14/336, 339, 340, 371, 432
CPC G09F 1/00; G09F 1/02; G09F 7/00; G09F 7/14; G09F 7/16; G09F 9/00; G09F 13/00; G09F 13/04; G09F 13/18; G09F 13/22; G09F 15/00; G09F 15/02; A47G 1/06; A47G 1/14

- 1. Digital signage
- 1.1 : Perspective
- 1.2 : Front
- 1.3 : Back
- 1.4 : Left
- 1.5 : Right
- 1.6 : Top
- 1.7 : Bottom

See application file for complete search history.

1 Claim, 7 Drawing Sheets

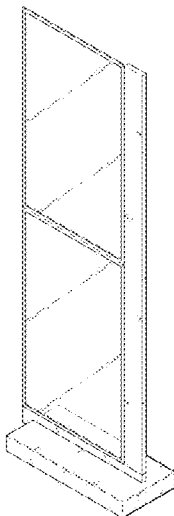

1.1

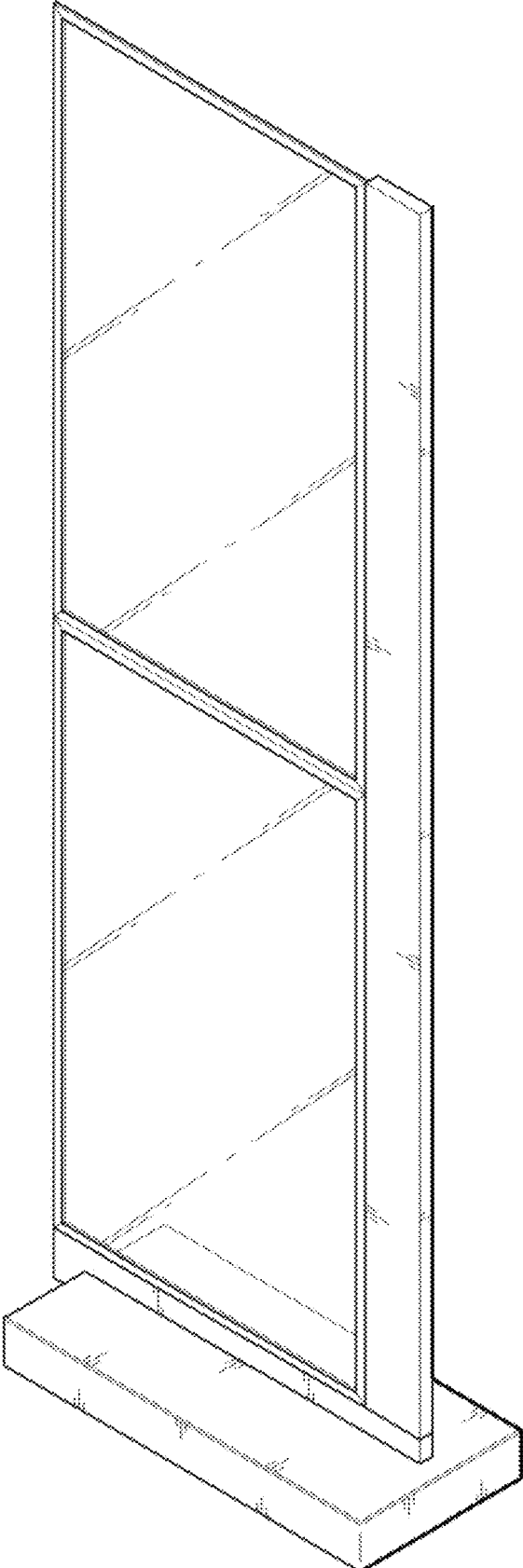

1.2

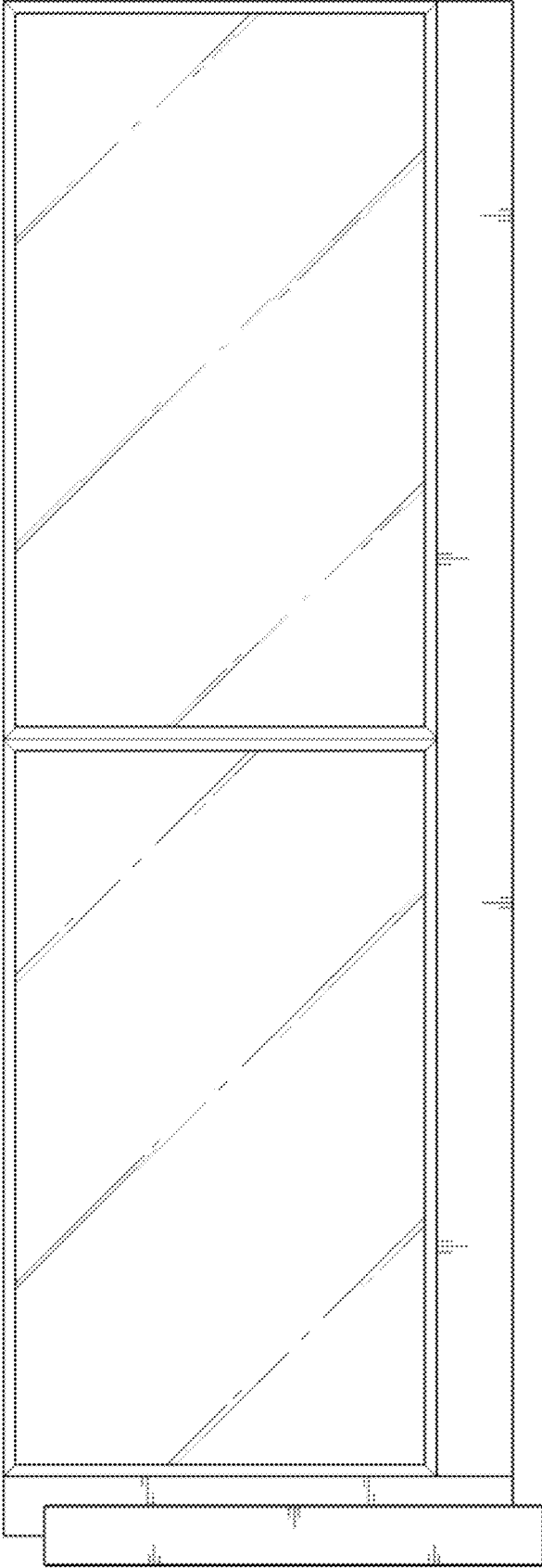

1.3

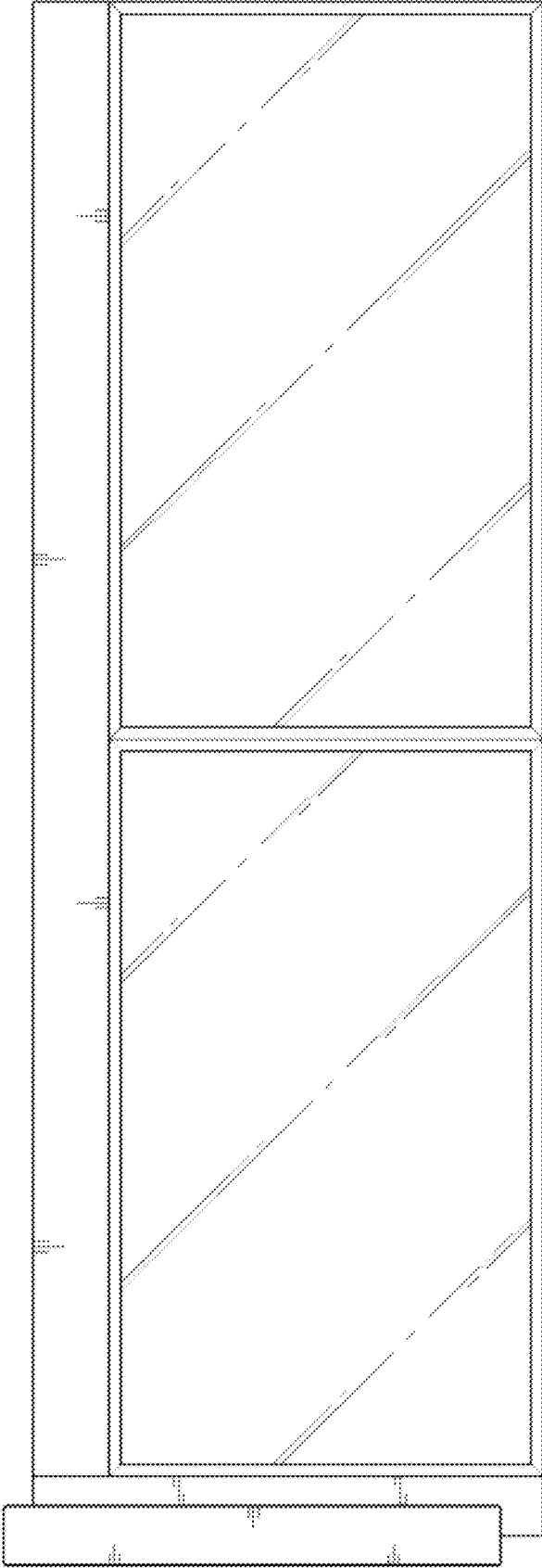

1.4

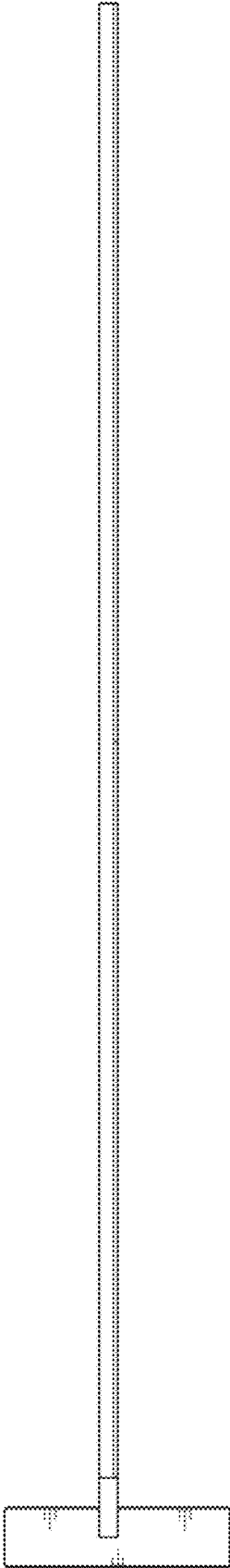

1.5

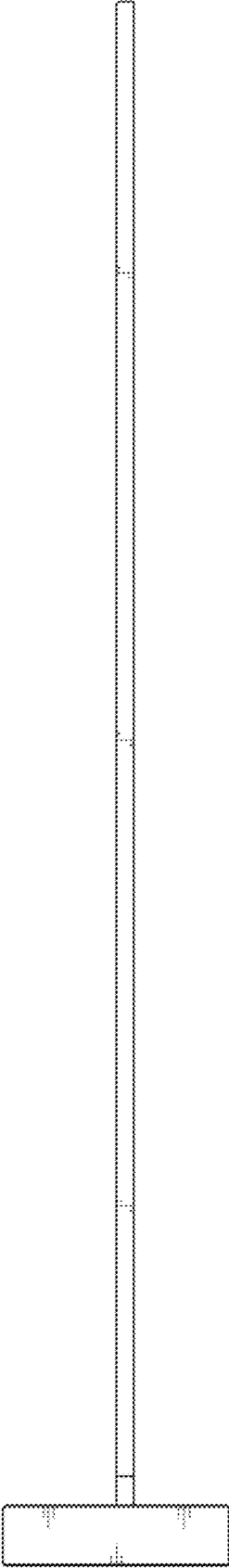

1.6

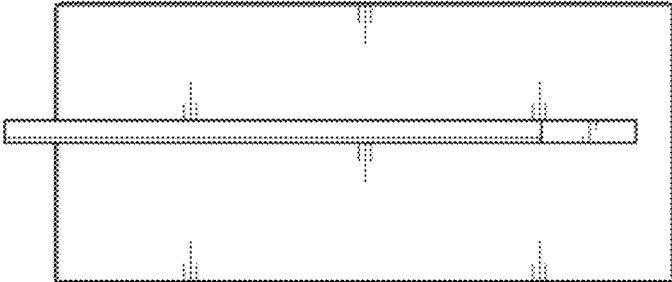

1.7

