



US00D936974S

(12) **United States Design Patent**
Oyelude

(10) **Patent No.:** **US D936,974 S**

(45) **Date of Patent:** **** Nov. 30, 2021**

(54) **FOLDABLE TOOTHBRUSH**

(71) Applicant: **Omolola Oyelude**, South Ozone Park, NY (US)

(72) Inventor: **Omolola Oyelude**, South Ozone Park, NY (US)

(**) Term: **15 Years**

(21) Appl. No.: **29/718,858**

(22) Filed: **Dec. 30, 2019**

(51) **LOC (13) Cl.** **04-02**

(52) **U.S. Cl.**

USPC **D4/104**

(58) **Field of Classification Search**

USPC D4/100-138; D8/90, 105, 107, 300, 303; D32/50, 51, 52; D28/7, 63; D7/393, D7/395, 401.2; D24/176, 181
CPC A46B 2200/1066; A46B 2200/1046; A46B 2200/3093; A46B 9/04; A46B 13/023; A46B 5/0095; A61C 15/00; Y10S 15/00; Y10S 15/10

See application file for complete search history.

(56) **References Cited**

U.S. PATENT DOCUMENTS

1,296,186 A 3/1919 Hines
2,216,026 A 9/1940 Smith
(Continued)

FOREIGN PATENT DOCUMENTS

DE 000059233-0001 * 12/2003
EM 008020218-0001 * 7/2020
EP 2 702 897 A2 3/2014

OTHER PUBLICATIONS

Amazon Folding Brush, announced Jan. 2018 [online], [site visited Mar. 22, 2021]. Available from internet, URL: https://www.amazon.com/Toothbrush-Folding-Feature-bristle-brushes/dp/B07M6M3LS3/ref=sr_1_6_sspa (Year: 2018).*

(Continued)

Primary Examiner — George A Bugg

Assistant Examiner — Tamara L Hahn

(74) *Attorney, Agent, or Firm* — Lawrence G. Fridman, Esq.; Feigin & Fridman, LLC

(57) **CLAIM**

The ornamental design for a foldable toothbrush, as shown and described.

DESCRIPTION

FIG. 1 is a perspective view of a foldable toothbrush in a folded position according to my new design; FIG. 2 is a top plan view thereof; FIG. 3 is one side elevational view thereof; FIG. 4 is a rear elevational view thereof; FIG. 5 is a front elevational view thereof; FIG. 6 is another side elevational view thereof; FIG. 7 is a bottom plan view thereof; FIG. 8 is a top plan view a foldable toothbrush in an unfolded position having a lid closed and the brush extended; FIG. 9 is one side elevational view thereof; FIG. 10 is a top plan view a foldable toothbrush in an unfolded position g the lid open and the brush extended; FIG. 11 is one side elevational view thereof; FIG. 12 is a top perspective view a foldable toothbrush in an unfolded position having the lid open and the brush extended; FIG. 13 is a top perspective view of a foldable toothbrush in a semi-unfolded position having the lid open and the brush folded into an internal recess; and, FIG. 14 is a perspective view of a foldable toothbrush in the folded position with the outwardly extending brush. The broken lines are for the purpose of illustrating an environmental structure and form no part of the claimed design.

1 Claim, 6 Drawing Sheets

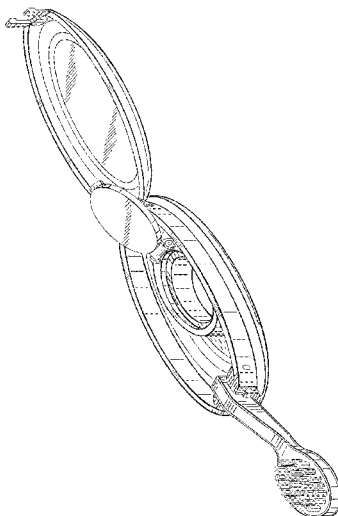

(56)

References Cited

U.S. PATENT DOCUMENTS

3,734,118 A 5/1973 Howard
 5,476,334 A 12/1995 Tello-Valarino
 5,735,298 A 4/1998 Mayne et al.
 D429,888 S 8/2000 Coopersmith et al.
 D455,235 S * 4/2002 Braaten D28/78
 6,643,887 B1 * 11/2003 Foley A46B 5/0033
 15/167.1
 D506,068 S 6/2005 Senyuva
 D516,317 S 3/2006 Wong
 D519,738 S 5/2006 Baertschi
 7,093,363 B1 8/2006 Kuo
 D599,958 S * 9/2009 Washington D28/82
 8,800,573 B2 8/2014 Hofstad
 D740,692 S * 10/2015 Christie D9/748
 D742,120 S 11/2015 Dalton
 9,427,077 B1 8/2016 Zhang
 D848,059 S * 5/2019 Vennemeyer D28/7

D866,982 S * 11/2019 Rosenzweig D4/116
 2005/0194016 A1 * 9/2005 Yeh A46B 15/0024
 132/121
 2010/0071144 A1 3/2010 Nanda

OTHER PUBLICATIONS

Gum Folding Toothbrush, announced Mar. 2009 [online], [site visited Mar. 22, 2021]. Available from internet, URL: https://www.amazon.com/Travel-Toothbrush-Antibacterial-Bristles-Count/dp/B01LXFSJY7/ref=psdc_3778211_t1_B07M6M3LS3 (Year: 2009).
 Mouthwatchers, announced 2016 [online], [site visited Mar. 22, 2021]. Available from internet, URL: https://www.amazon.com/dp/B018N0LU20/ref=sspa_dk_detail_0 (Year: 2016).
 Container Store, announced 2013 [online], [site visited Mar. 22, 2021]. Available from internet, URL: <https://www.containerstore.com/s/travel/makeup-toiletries/folding-toothbrush-with-microban/12d?productId=10029778> (Year: 2013).

* cited by examiner

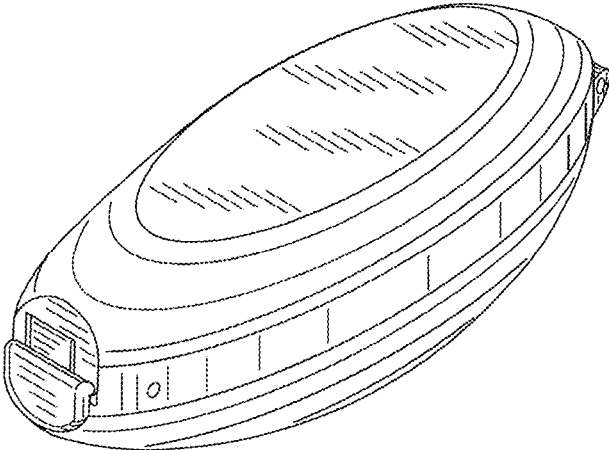

FIG. 1

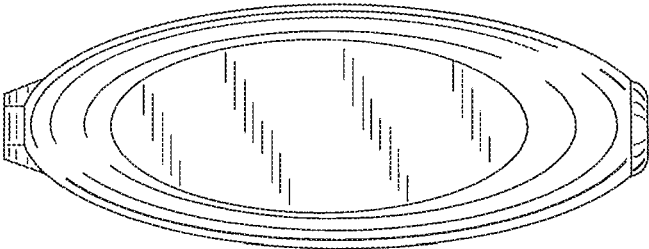

FIG. 2

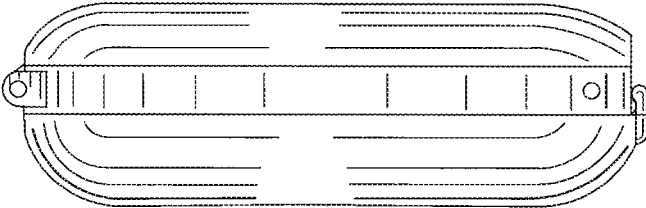

FIG. 3

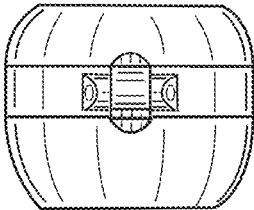

FIG. 4

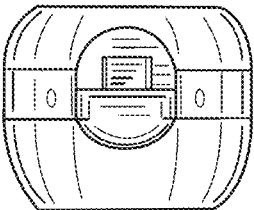

FIG. 5

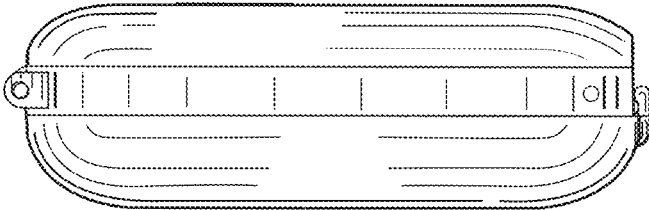

FIG. 6

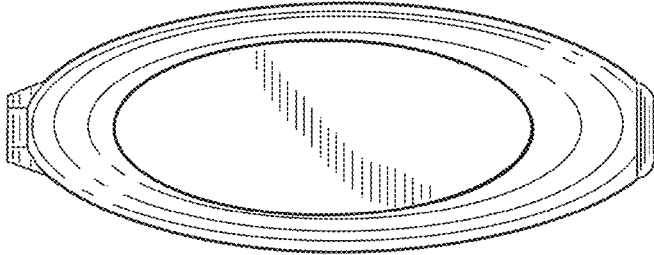

FIG. 7

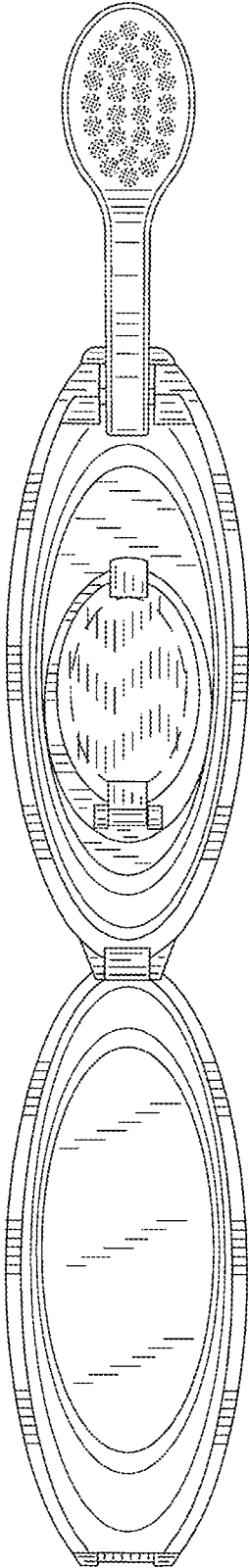

FIG. 8

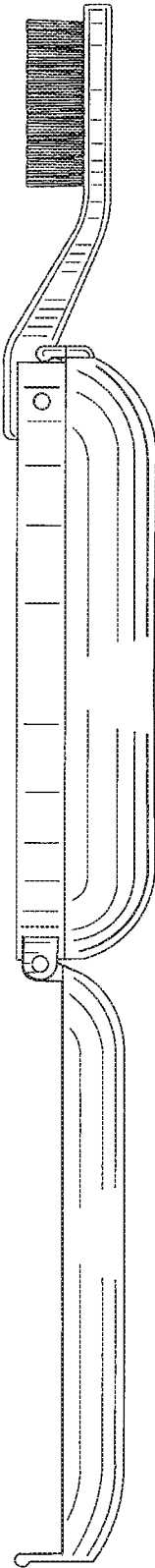

FIG. 9

FIG. 10

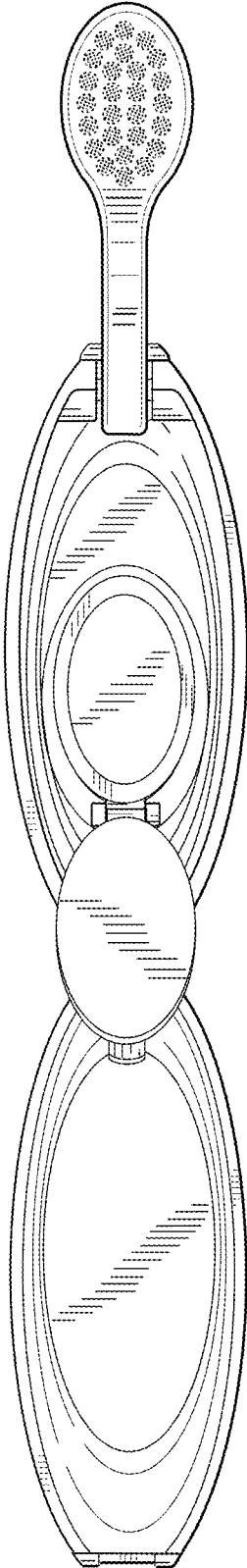
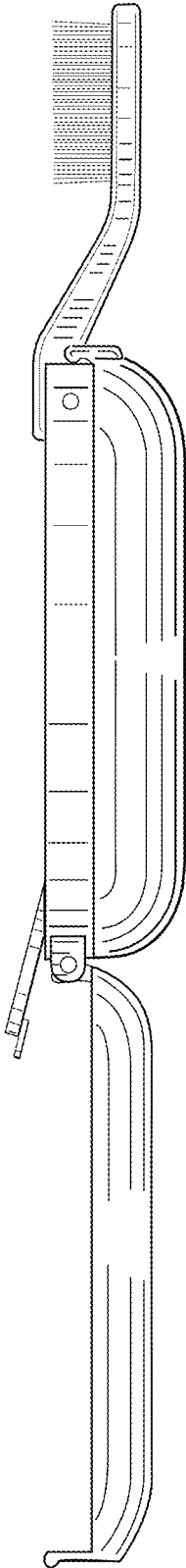

FIG. 11



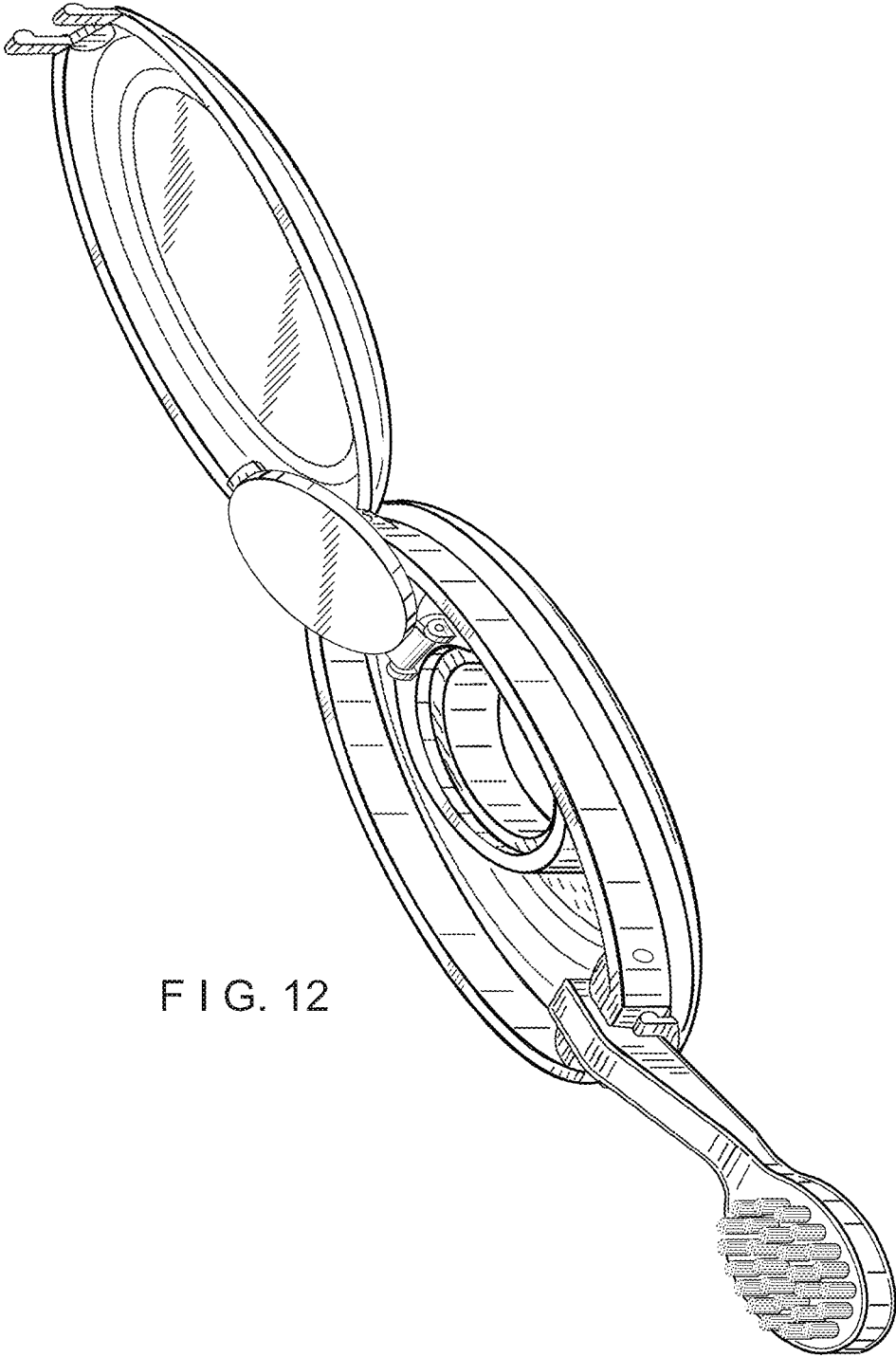

FIG. 12

