



US00D694608S

(12) **United States Design Patent**
Nelson et al.

(10) **Patent No.:** **US D694,608 S**

(45) **Date of Patent:** **** Dec. 3, 2013**

(54) **TOOL HANDLE**

(71) Applicants: **Michael Nelson**, Peachtree City, GA
(US); **Bradley Spieker**, Acworth, GA
(US)

(72) Inventors: **Michael Nelson**, Peachtree City, GA
(US); **Bradley Spieker**, Acworth, GA
(US)

(73) Assignee: **Homer TLC, Inc.**, Wilmington, DE
(US)

(**) Term: **14 Years**

(21) Appl. No.: **29/439,584**

(22) Filed: **Dec. 12, 2012**

(51) **LOC (9) Cl.** **08-04**

(52) **U.S. Cl.**
USPC **D8/83**

(58) **Field of Classification Search**
USPC D8/82-87, 98-99, 105, 107; 7/165,
7/167, 169; 81/177.1-177.7, 436, 438,
81/489; 362/120

See application file for complete search history.

(56) **References Cited**

U.S. PATENT DOCUMENTS

D375,669	S	*	11/1996	Shiao	D8/83
D400,420	S	*	11/1998	Shiao	D8/83
D401,491	S	*	11/1998	Shiao	D8/83
D422,474	S	*	4/2000	Shiao	D8/83
D424,904	S	*	5/2000	Hasan	D8/83
D487,690	S	*	3/2004	Hu	D8/83
D503,606	S	*	4/2005	McKain	D8/82
D510,692	S	*	10/2005	Walker	D8/83
D513,378	S	*	1/2006	Lin	D8/83
D531,480	S	*	11/2006	Tsai	D8/107
D534,052	S	*	12/2006	Lin	D8/107
D644,902	S	*	9/2011	Yang	D8/83

* cited by examiner

Primary Examiner — Philip S Hyder
Assistant Examiner — Roselyne Cody
(74) *Attorney, Agent, or Firm* — Fulbright & Jaworski LLP

(57) **CLAIM**

The ornamental design for a tool handle, as shown and described.

DESCRIPTION

FIG. 1 is a perspective view of a first embodiment of a tool handle;
 FIG. 2 is a bottom view of the tool handle shown in FIG. 1;
 FIG. 3 is a top view of the tool handle shown in FIG. 1;
 FIG. 4 is a front view of the tool handle shown in FIG. 1, the back view being identical;
 FIG. 5 is a right side view of the tool handle shown in FIG. 1, the left side view being identical;
 FIG. 6 is another perspective view of the tool handle shown in FIG. 1 that also shows an unclaimed identifier in dashed lines along a flat segment of the tool handle and another unclaimed identifier in dashed lines on the top of the tool handle;
 FIG. 7 is another top view of the tool handle shown in FIG. 1 that also shows an unclaimed identifier in dashed lines on the top of the tool handle;
 FIG. 8 is a second embodiment that differs from the first embodiment of FIG. 1 in that no portion of the tool handle of the second embodiment is transparent or translucent, as is the portion of the tool handle of the first embodiment that is characterized by oblique line shading;
 FIG. 9 is a top view of the tool handle shown in FIG. 8;
 FIG. 10 is a bottom view of the tool handle shown in FIG. 8;
 FIG. 11 is a front view of the tool handle shown in FIG. 8, the back view being identical; and,
 FIG. 12 is a right side view of the tool handle shown in FIG. 8, the left side view being identical.
 The dashed lines in FIGS. 1-5 represent a tool or tool portion, such as a screwdriver shank, that may extend from the tool handle, and form no part of the claimed design; such dashed lines also appear in FIGS. 6, 8, 9, 11, and 12. The remaining dashed line in FIGS. 6 and 7 represent example identifiers that form no part of the claimed design.

1 Claim, 5 Drawing Sheets

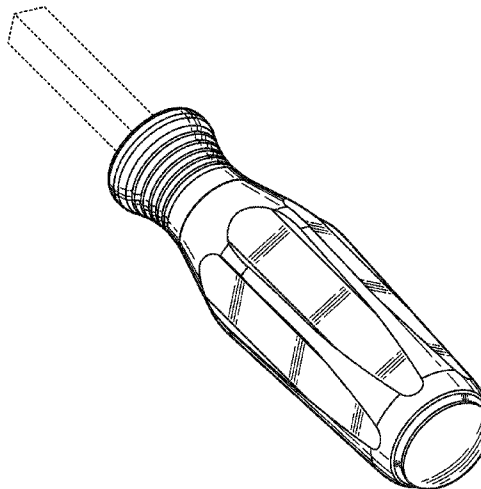
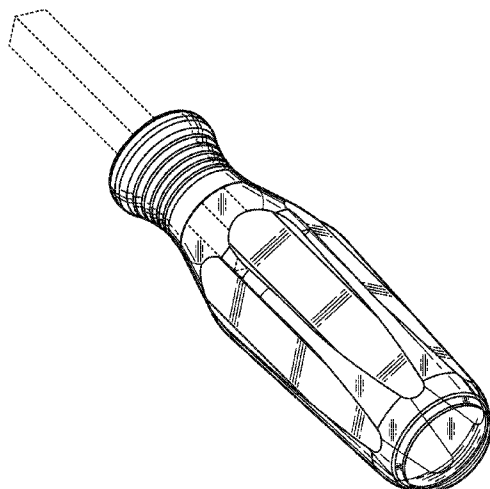

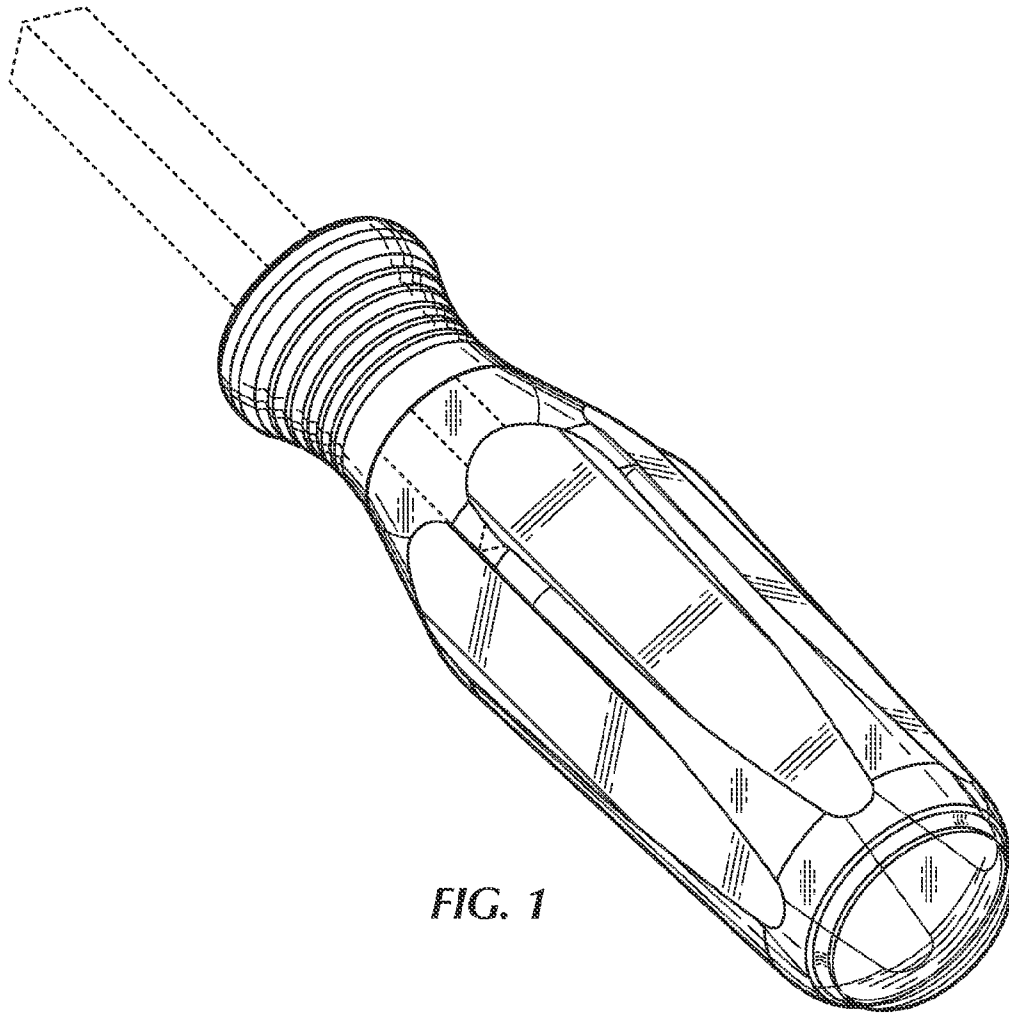

FIG. 1

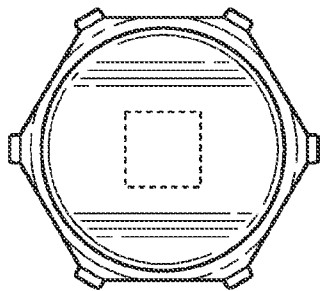

FIG. 2

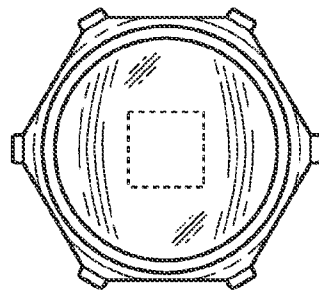

FIG. 3

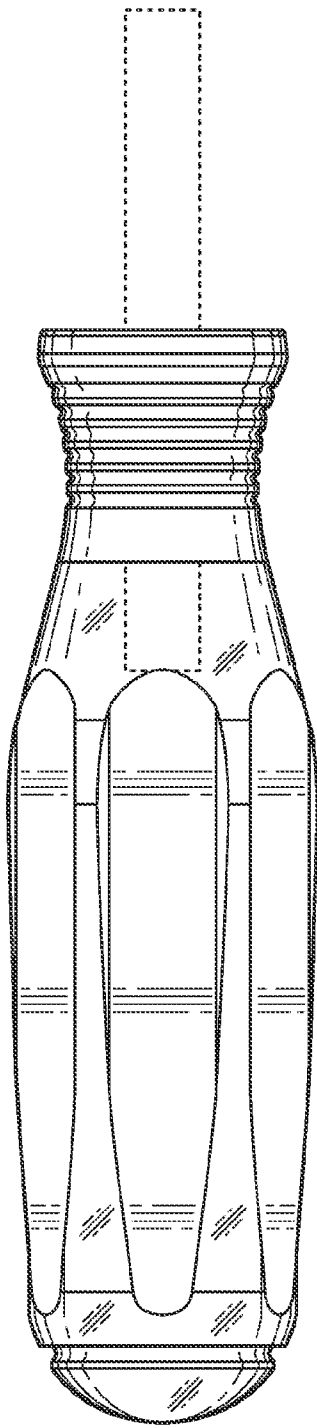

FIG. 4

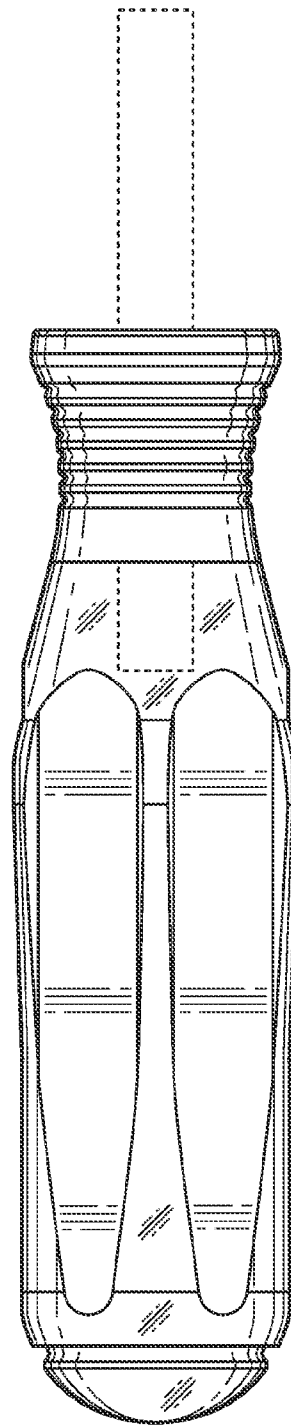

FIG. 5

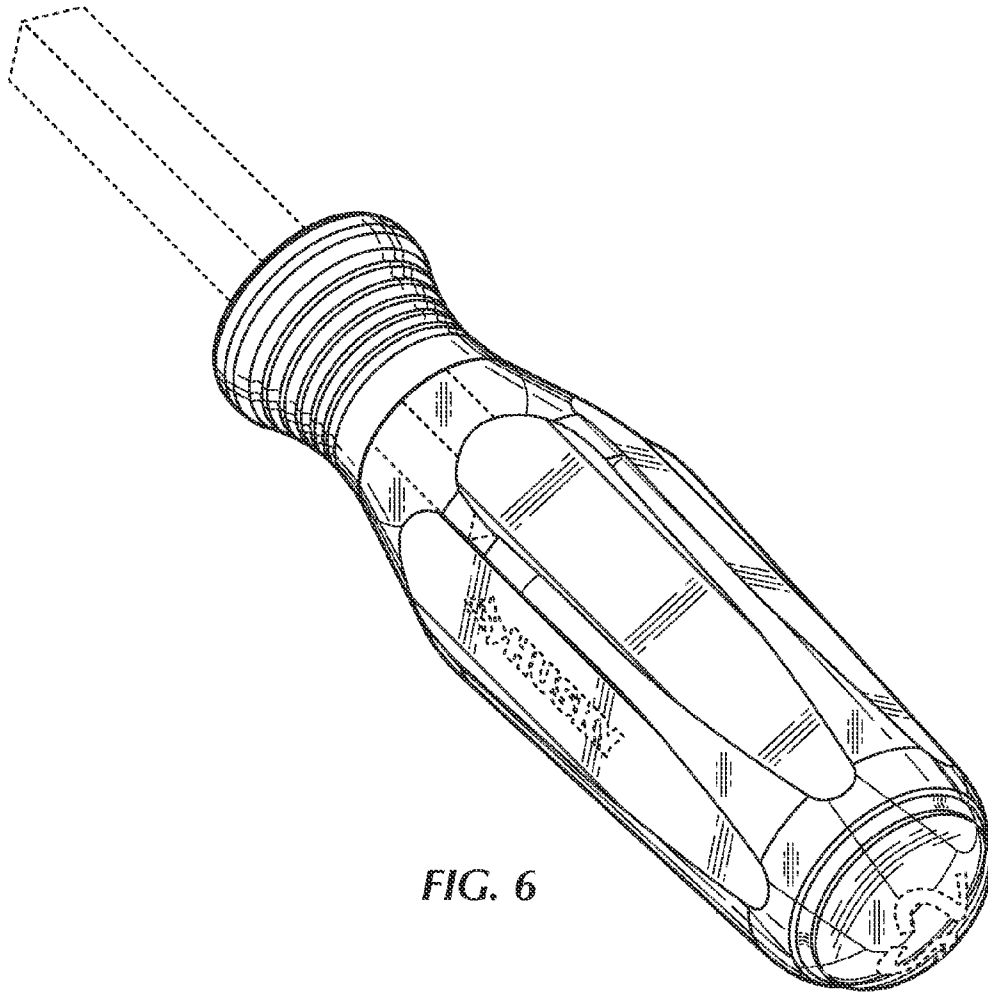

FIG. 6

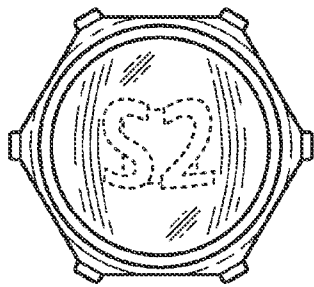

FIG. 7

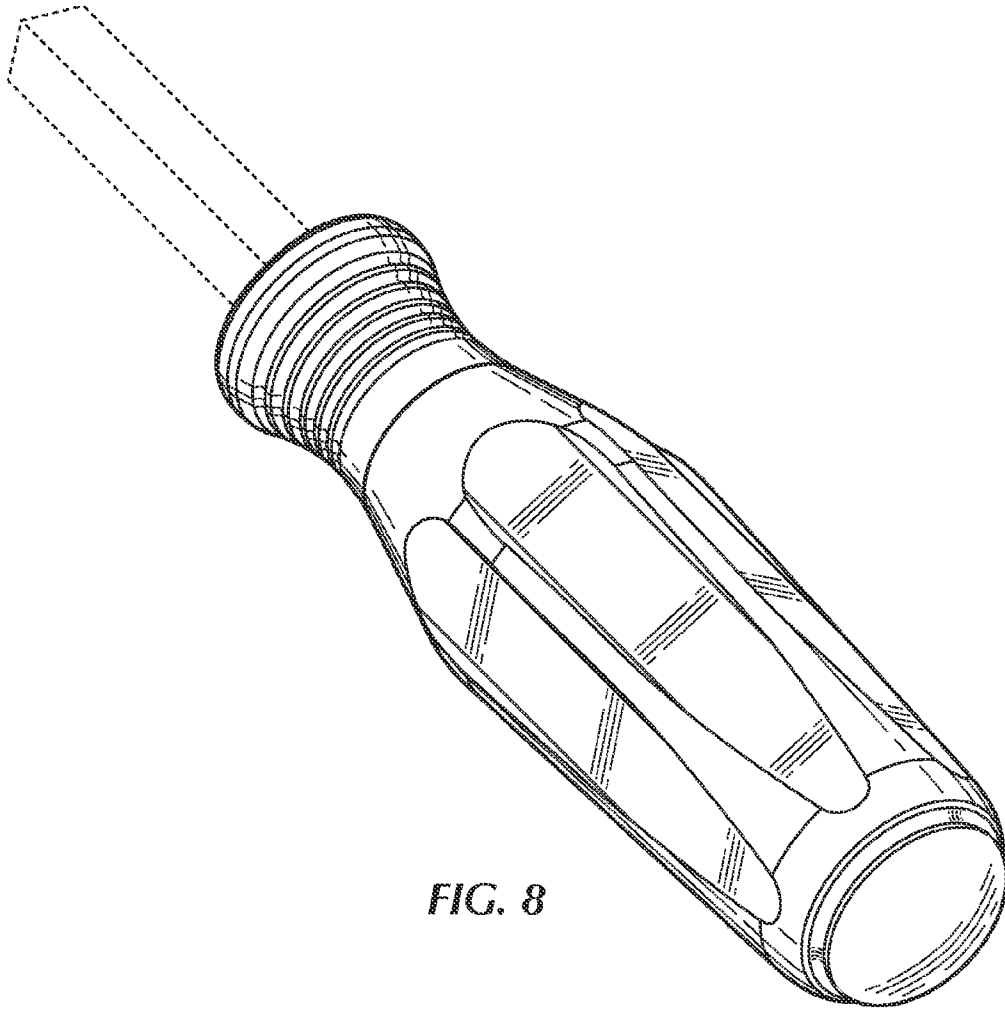

FIG. 8

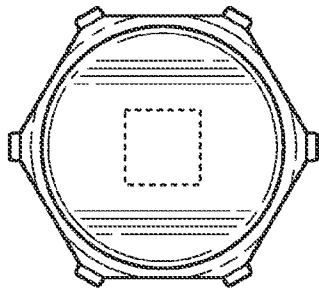

FIG. 9

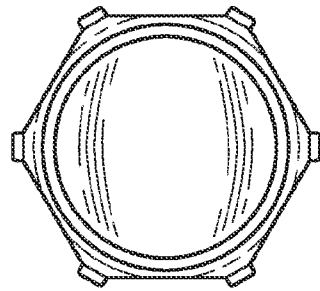

FIG. 10

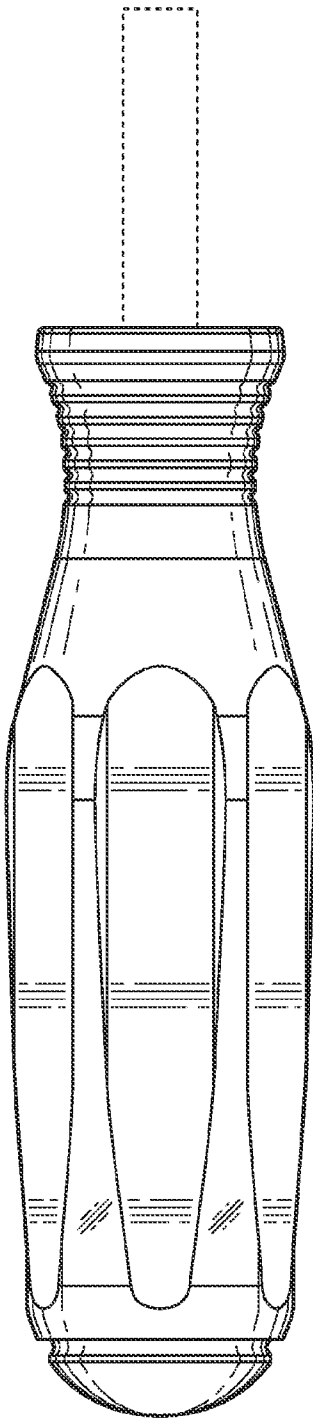

FIG. 11

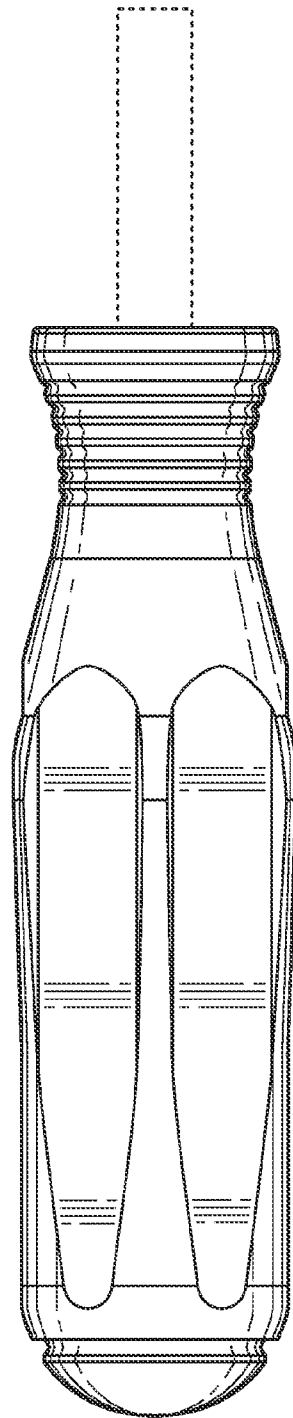

FIG. 12

UNITED STATES PATENT AND TRADEMARK OFFICE
CERTIFICATE OF CORRECTION

PATENT NO. : D694,608 S
APPLICATION NO. : 29/439584
DATED : December 3, 2013
INVENTOR(S) : Michael Nelson et al.

Page 1 of 1

It is certified that error appears in the above-identified patent and that said Letters Patent is hereby corrected as shown below:

ON THE TITLE PAGE

DESCRIPTION - FIG. 9

Change "top" to -- bottom --.

DESCRIPTION - FIG. 10

Change "bottom" to -- top --.

DESCRIPTION - Last paragraph

Change "FIGS. 1-5" to -- FIGS. 1-5, 6, 8, 9, 11, and 12 --.

DESCRIPTION - Last paragraph

Change "claimed design;" to -- claimed design. -- and delete "such dashed lines also appear in FIGS. 6, 8, 9, 11 and 12."

Signed and Sealed this
Fifteenth Day of April, 2014

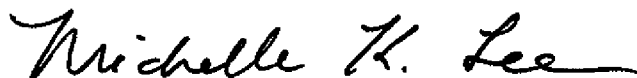

Michelle K. Lee

Deputy Director of the United States Patent and Trademark Office