



US00D461645S

(12) **United States Design Patent** (10) **Patent No.:** **US D461,645 S**  
**Hartenstine et al.** (45) **Date of Patent:** **\*\* Aug. 20, 2002**

(54) **PLAYARD WITH INWARDLY CURVING LEGS**  
(75) Inventors: **Curtis M. Hartenstine**, Birdsboro;  
**Michael L. Longenecker**, Ephrata, both  
of PA (US)  
(73) Assignee: **Graco Children's Products Inc.**,  
Elverson, PA (US)  
(\*\*) Term: **14 Years**

(21) Appl. No.: **29/141,543**  
(22) Filed: **May 9, 2001**  
(51) **LOC (7) Cl.** ..... **06-01**  
(52) **U.S. Cl.** ..... **D6/331; D6/391**  
(58) **Field of Search** ..... **D6/382, 390, 391,**  
**D6/331, 503; 5/93.1, 93.2, 100, 101**

(56) **References Cited**  
**U.S. PATENT DOCUMENTS**  
4,739,527 A 4/1988 Kohus et al.  
5,339,470 A \* 8/1994 Shamie ..... 5/98.1  
D382,718 S \* 8/1997 Mariol ..... D6/331  
5,752,283 A \* 5/1998 Arens ..... 5/99.1  
D448,218 S \* 9/2001 Celestina-Krevh ..... D6/495

\* cited by examiner

*Primary Examiner*—Janice E. Seeger  
(74) *Attorney, Agent, or Firm*—Foley & Lardner

(57) **CLAIM**  
The ornamental design for a playard with inwardly curving legs, as shown and described.

**DESCRIPTION**  
FIG. 1 is a perspective view showing the playard with inwardly curving legs of our new design;  
FIG. 2 is a top plan view thereof;  
FIG. 3 is a bottom plan view thereof;  
FIG. 4 is a left side elevation view thereof, the right side elevation view being a mirror image of the left side elevation view;  
FIG. 5 is a front elevation view thereof, the rear elevation view being a mirror image of the front elevation view;  
FIG. 6 is a partial cross-section view thereof, taken along line 6—6 of FIG. 4, to more clearly show the inside thereof; and,  
FIG. 7 is a partial cross-section view thereof, taken along line 7—7 of FIG. 5, to more clearly show the inside thereof.  
The broken lines are for illustrative purposes only and do not form part of the claimed design.

**1 Claim, 7 Drawing Sheets**

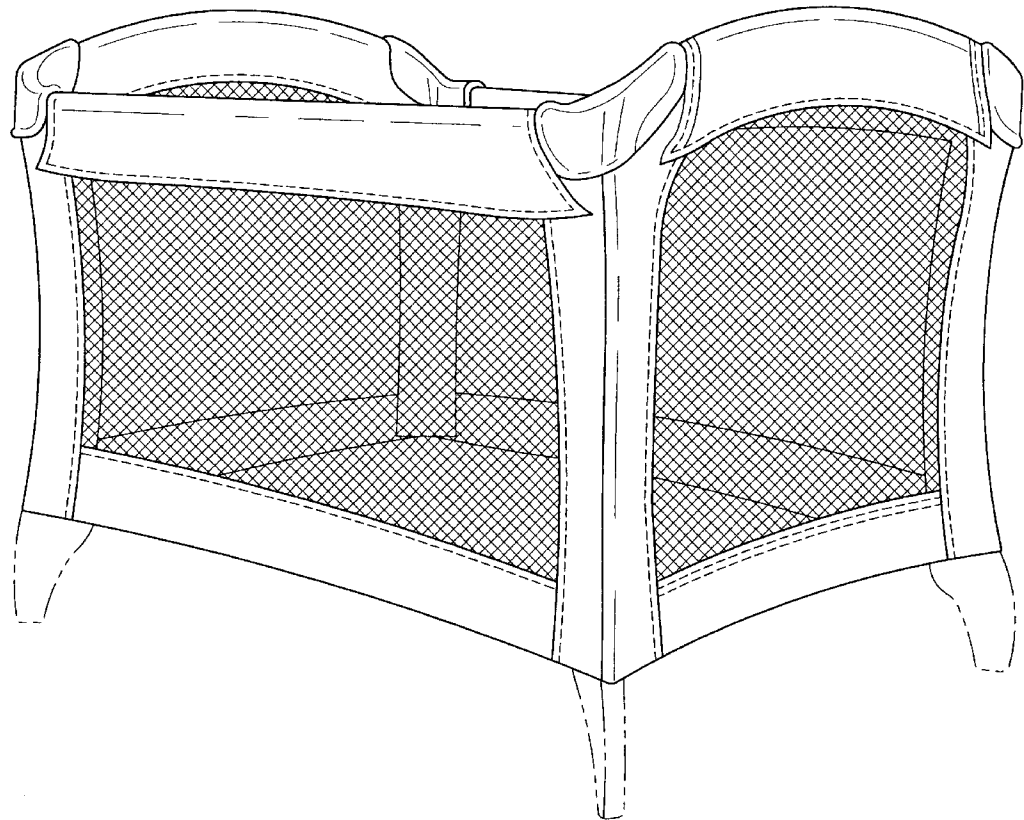

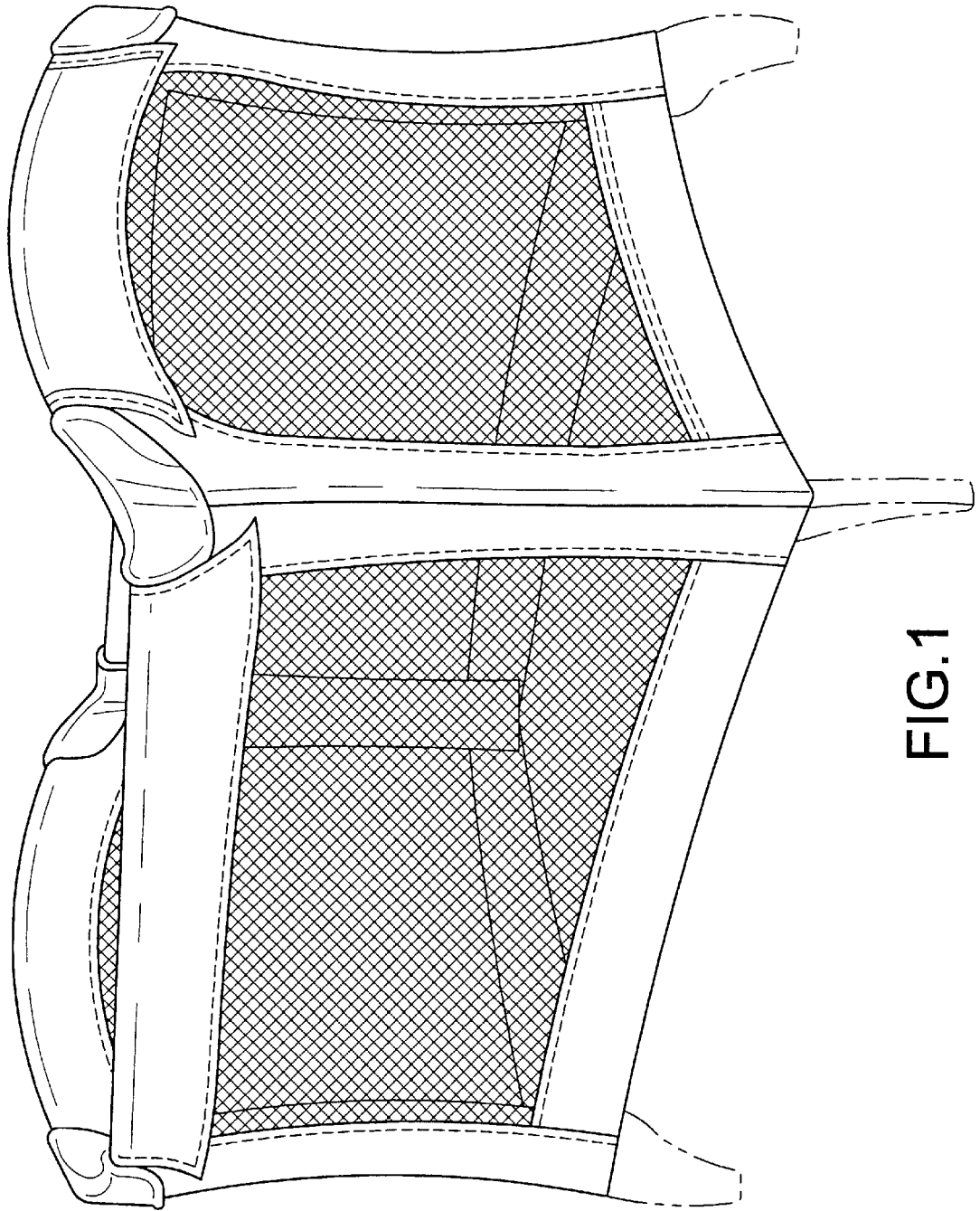

FIG. 1

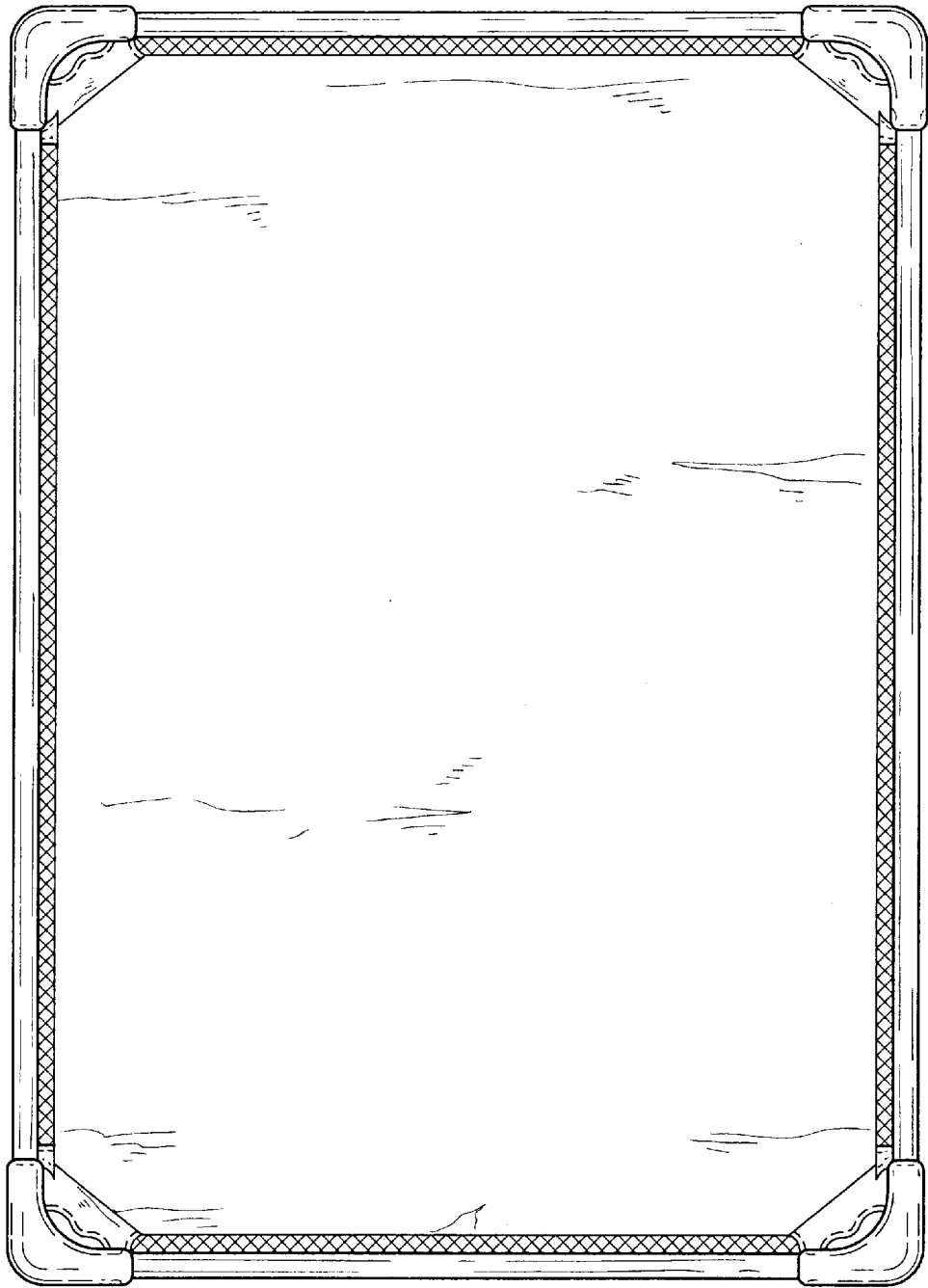

FIG.2

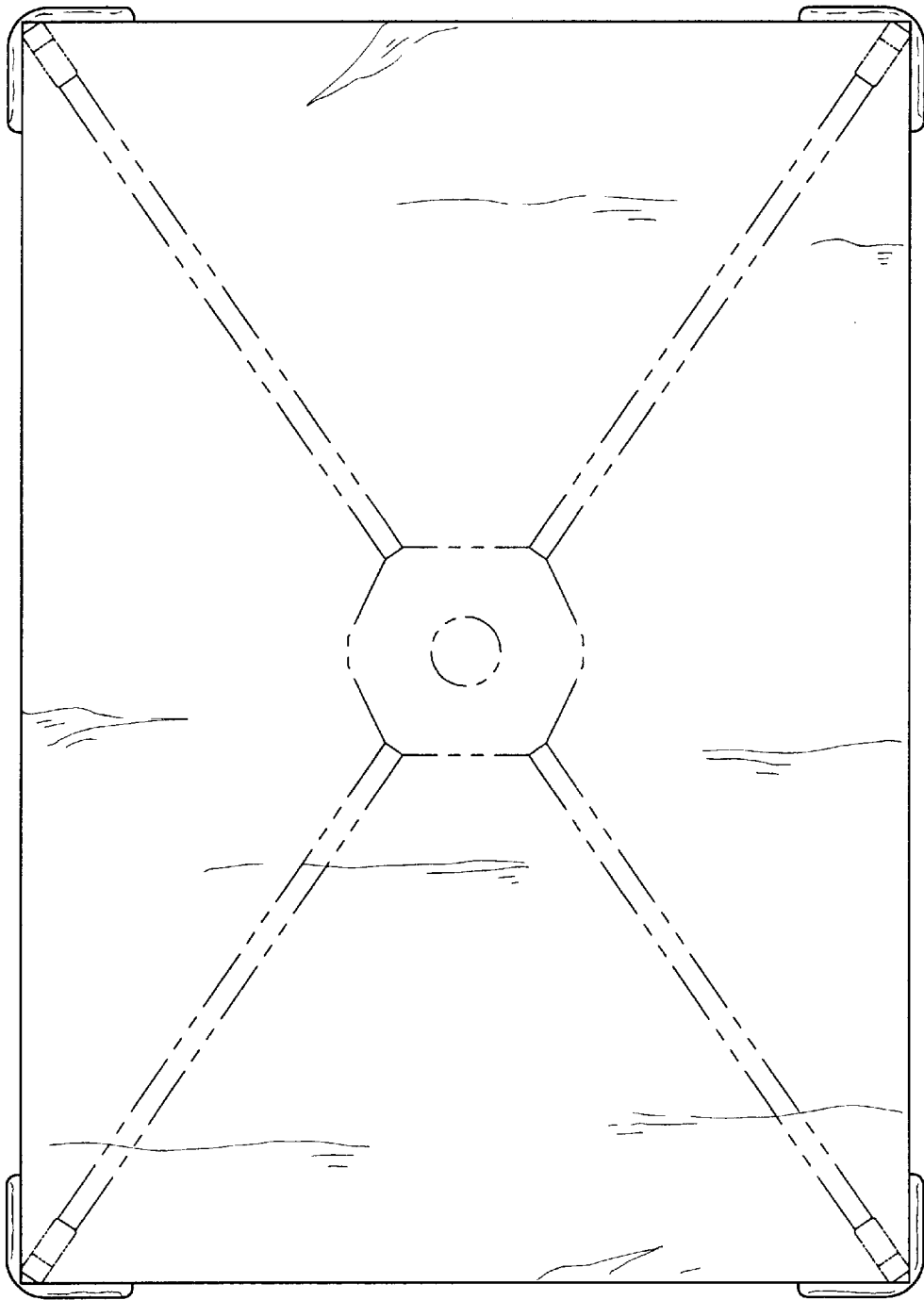

FIG.3

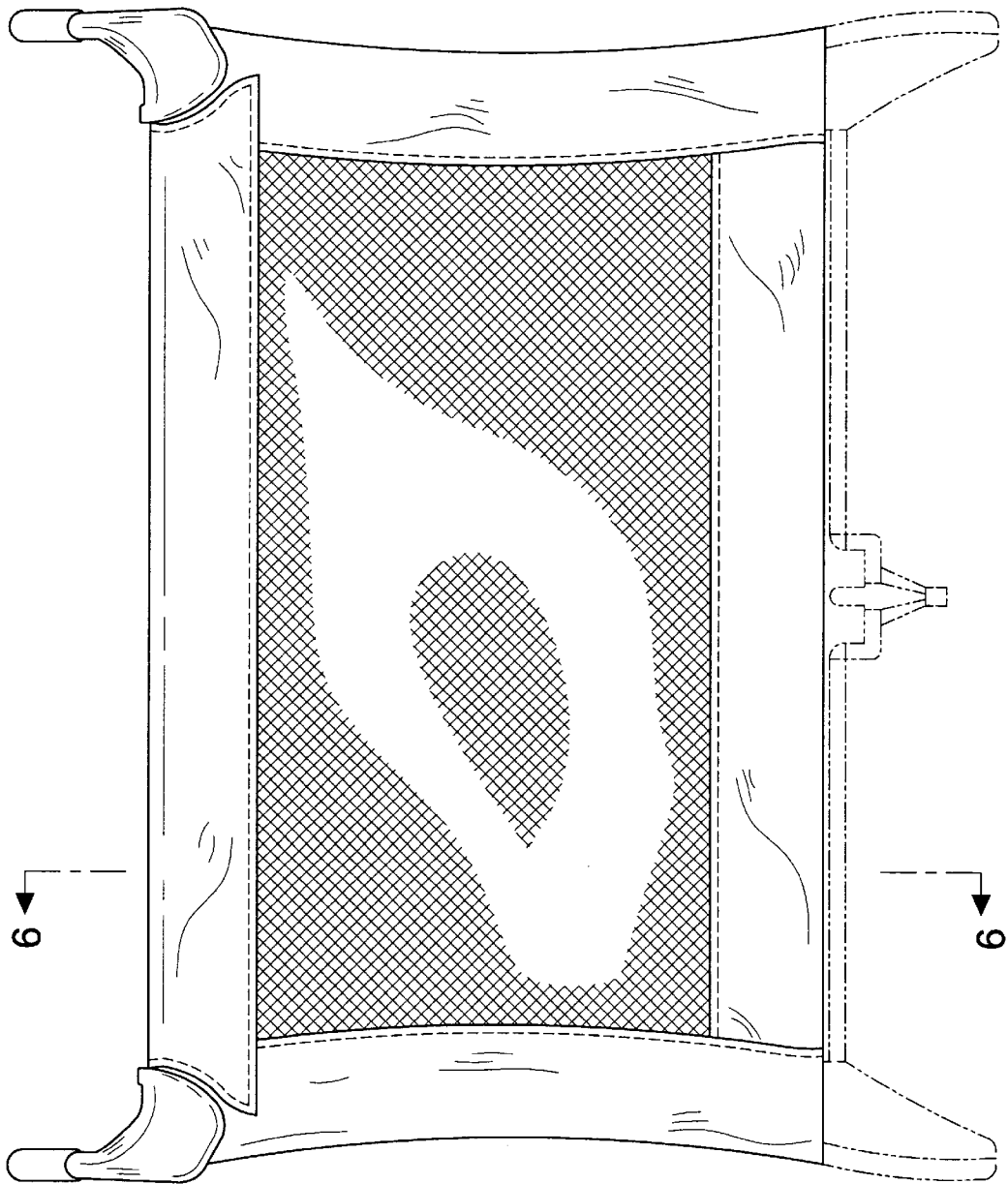

FIG.4

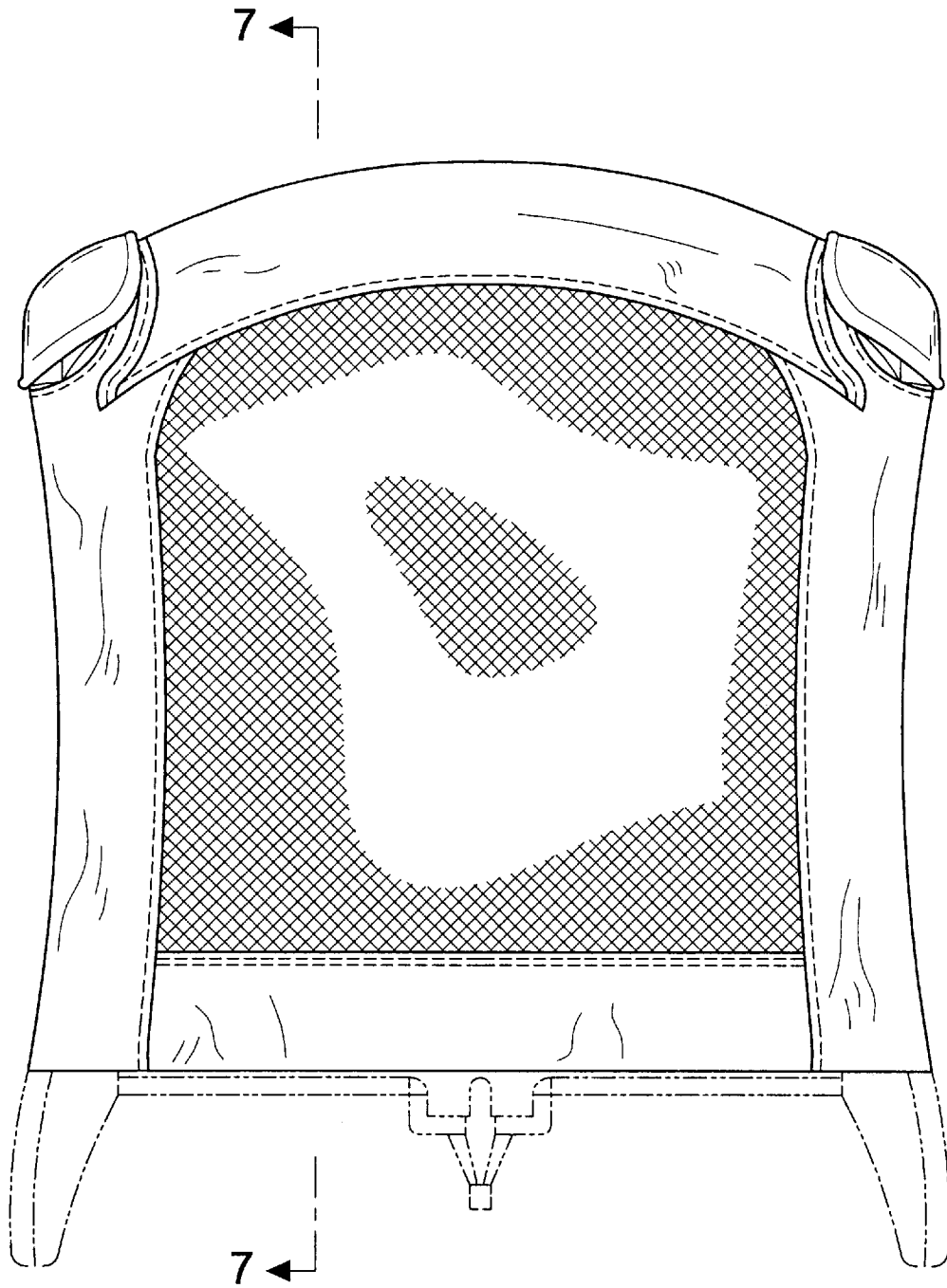

FIG.5

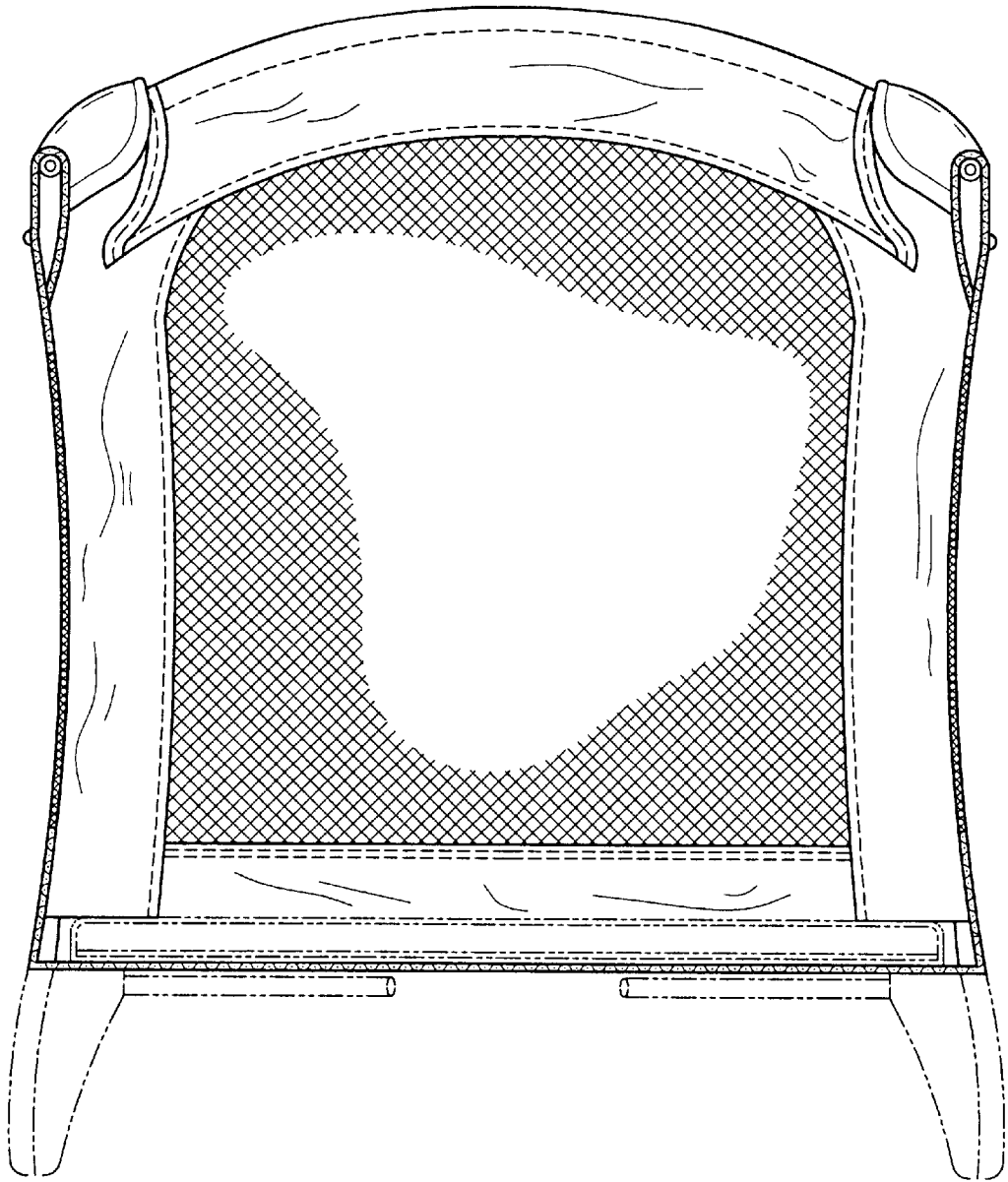

FIG. 6

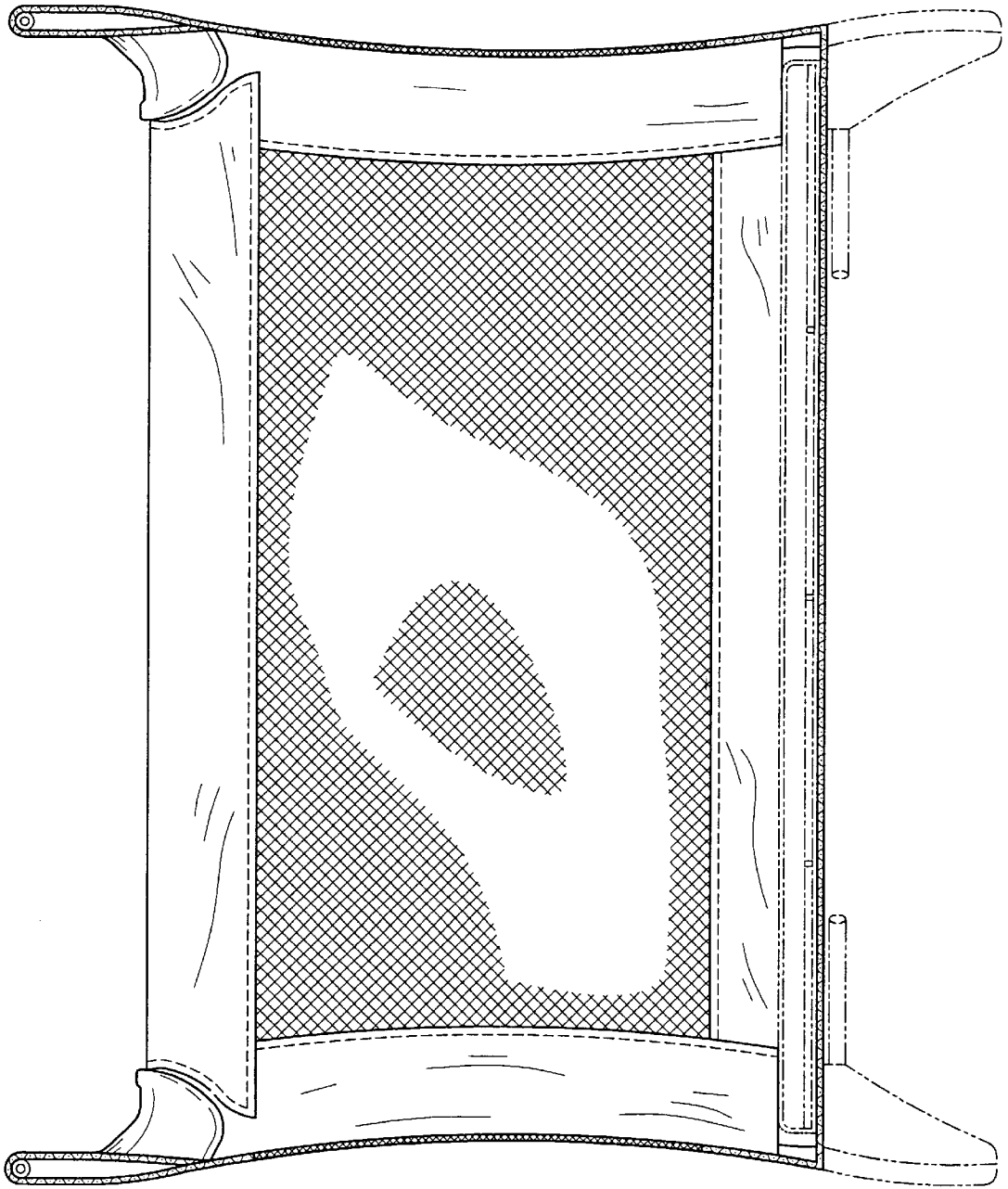

FIG. 7