



US00D512040S

(12) **United States Design Patent**  
**Kim et al.**

(10) **Patent No.:** **US D512,040 S**

(45) **Date of Patent:** **\*\* Nov. 29, 2005**

(54) **CELLULAR PHONE**

(75) Inventors: **Ki-Sung Kim**, Seoul (KR);  
**Chang-Hwan Hwang**, Goyang-si (KR);  
**Yoon-Young Cho**, Seoul (KR)

(73) Assignee: **Samsung Electronics Co., Ltd.** (KR)

(\*\*) Term: **14 Years**

(21) Appl. No.: **29/217,187**

(22) Filed: **Nov. 15, 2004**

(30) **Foreign Application Priority Data**

Jun. 9, 2004 (KR) ..... 30-2004-0017225

(51) **LOC (8) Cl.** ..... **14-03**

(52) **U.S. Cl.** ..... **D14/138**

(58) **Field of Search** ..... D14/137, 138,  
D14/147-148, 247-248, 144, 341-347;  
379/433.01-433.13, 434; 455/550.1-90.3,  
575.3, 566, 575.1; D21/517; 345/169

(56) **References Cited**

**U.S. PATENT DOCUMENTS**

D469,070 S	*	1/2003	Lee	.....	D14/138
D481,697 S	*	11/2003	Rausch et al.	.....	D14/138
D483,342 S	*	12/2003	Lee et al.	.....	D14/138
D484,863 S	*	1/2004	Chan	.....	D14/138
D485,248 S	*	1/2004	Ogawa	.....	D14/138
D485,818 S	*	1/2004	Yabe et al.	.....	D14/138
D486,462 S	*	2/2004	Lim	.....	D14/138
D487,443 S	*	3/2004	Yoon	.....	D14/138
D490,389 S	*	5/2004	Yang	.....	D14/138
D491,907 S	*	6/2004	Ogawa	.....	D14/138
D494,945 S	*	8/2004	Jang	.....	D14/138
D495,672 S	*	9/2004	Jeon et al.	.....	D14/138
D498,734 S	*	11/2004	Joung	.....	D14/138
D500,016 S	*	12/2004	Kim	.....	D14/138

D501,455 S	*	2/2005	Hunt et al.	.....	D14/138
D501,839 S	*	2/2005	Lee et al.	.....	D14/138
D502,457 S	*	3/2005	Eigenstetter et al.	.....	D14/138
2001/0036845 A1	*	11/2001	Park	.....	455/566
2003/0109232 A1	*	6/2003	Park et al.	.....	455/90
2004/0023684 A1	*	2/2004	Sato et al.	.....	455/550.1
2004/0097258 A1	*	5/2004	Lee et al.	.....	455/550.1
2004/0185920 A1	*	9/2004	Choi et al.	.....	455/575.1
2004/0185923 A1	*	9/2004	Park et al.	.....	455/575.1
2004/0192400 A1	*	9/2004	Chwa	.....	455/566
2004/0203535 A1	*	10/2004	Kim et al.	.....	455/90.3
2005/0003852 A1	*	1/2005	Song	.....	455/550.1

**FOREIGN PATENT DOCUMENTS**

JP	D1154363	*	9/2002
JP	D1183170	*	8/2003
JP	D1188710	*	10/2003

\* cited by examiner

*Primary Examiner*—Jeffrey Asch

(74) *Attorney, Agent, or Firm*—Cantor Colburn LLP

(57) **CLAIM**

We claim, the ornamental design for a cellular phone, as shown and described.

**DESCRIPTION**

FIG. 1 is a top and front perspective view of a cellular phone, showing our new design;  
FIG. 2 is a front elevational view thereof;  
FIG. 3 is a rear elevational view thereof;  
FIG. 4 is a left side elevational view thereof;  
FIG. 5 is a right side elevational view thereof;  
FIG. 6 is a top elevational view thereof;  
FIG. 7 is a bottom elevational view thereof; and,  
FIG. 8 is a front perspective view thereof, the cellular phone being in an alternate position.

**1 Claim, 3 Drawing Sheets**

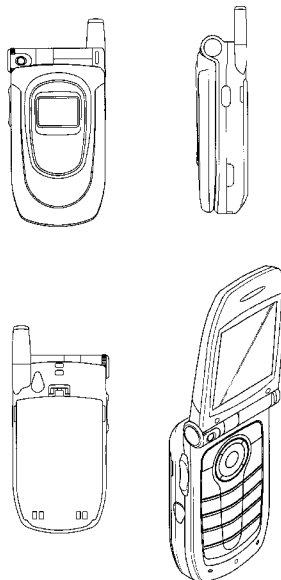

FIG. 1

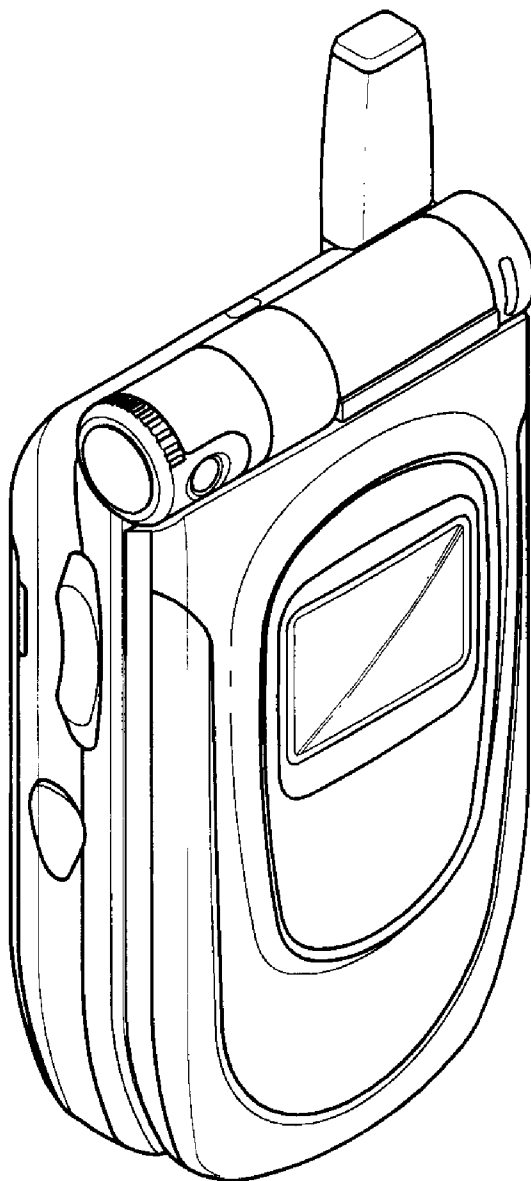

FIG.2

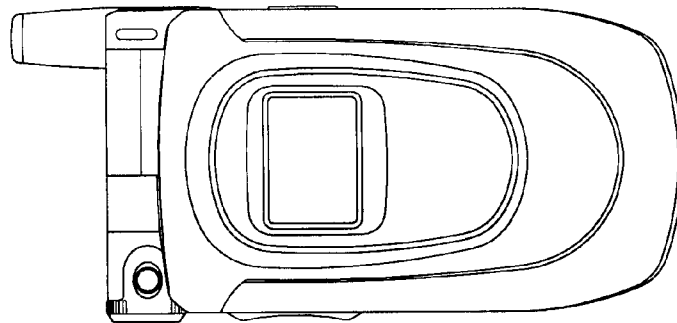

FIG.3

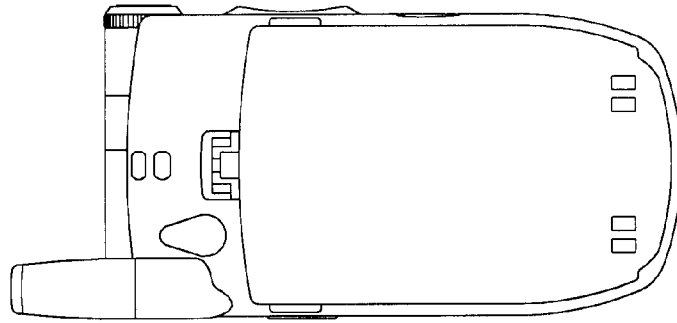

FIG.4

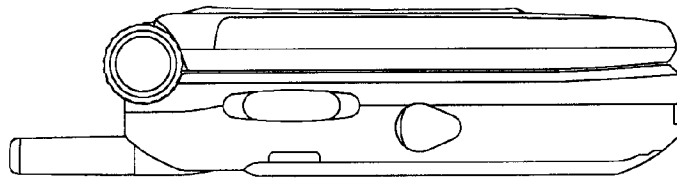

FIG.5

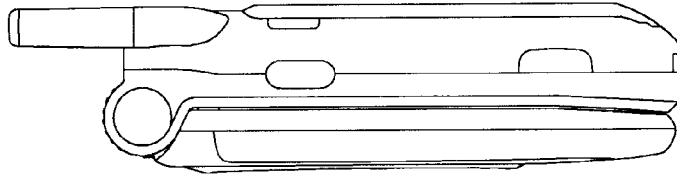

FIG. 6

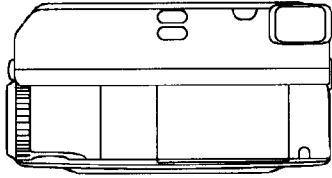

FIG. 7

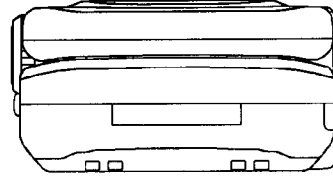

FIG. 8

