



US00D461089S

(12) **United States Design Patent** (10) **Patent No.:** **US D461,089 S**
Cheah et al. (45) **Date of Patent:** **** Aug. 6, 2002**

(54) **TOASTER**

D383,352 S * 9/1997 Powel D7/330
D401,472 S * 11/1998 Gould D7/330
6,205,911 B1 * 3/2001 Ochoa 99/331

(75) Inventors: **Aik Pin Cheah**, Wheelers Hill; **Marc Anthony Fraser**, Blackburn, both of (AU)

* cited by examiner

(73) Assignee: **Mistral International Pty Ltd.**, Dandenong (AU)

Primary Examiner—Caron D. Veynar
(74) *Attorney, Agent, or Firm*—Klauber & Jackson

(**) Term: **14 Years**

(57) **CLAIM**

(21) Appl. No.: **29/147,506**

The ornamental design for a toaster, as shown.

(22) Filed: **Aug. 30, 2001**

DESCRIPTION

(30) **Foreign Application Priority Data**

FIG. 1 is a right front perspective view of a toaster showing our new design;

Mar. 30, 2001 (AU) 1056/2001

FIG. 2 is a left rear perspective view thereof;

(51) **LOC (7) Cl.** **07-02**

FIG. 3 is a top view thereof;

(52) **U.S. Cl.** **D7/330**

FIG. 4 is a front view thereof;

(58) **Field of Search** D7/328–330, 390;
99/331–335, 372, 385, 389

FIG. 5 is a left side view thereof, the right side being the mirror image thereof;

(56) **References Cited**

FIG. 6 is a rear view thereof; and,

U.S. PATENT DOCUMENTS

FIG. 7 is a bottom view thereof.

D112,252 S * 11/1938 Hadley D7/328

1 Claim, 2 Drawing Sheets

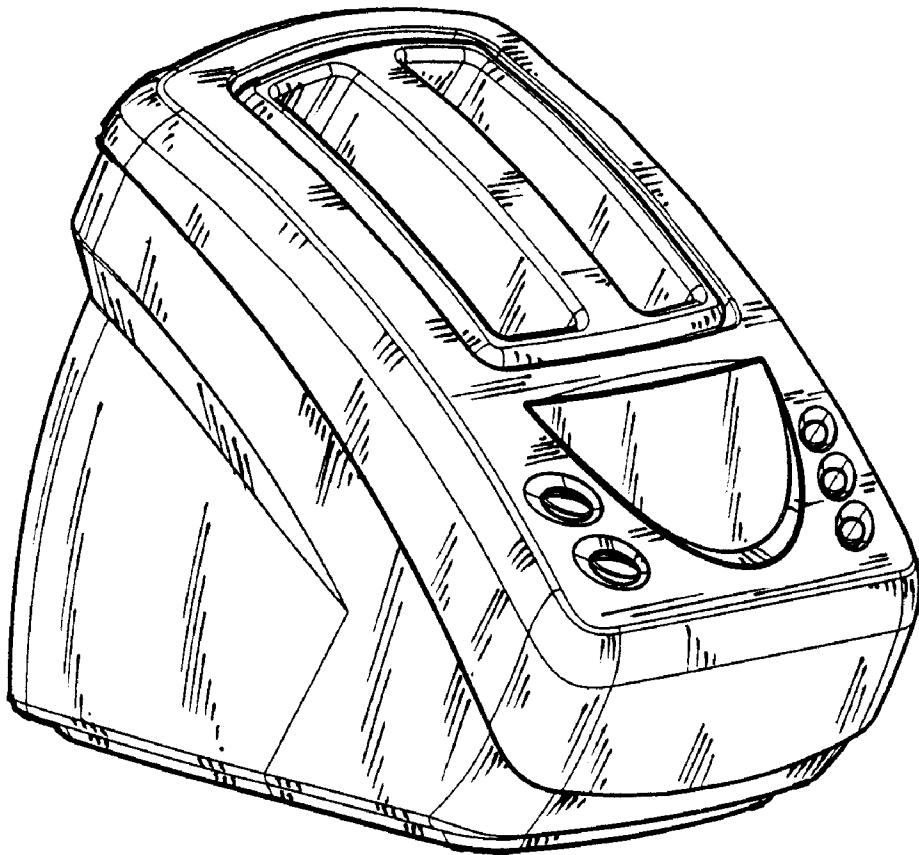

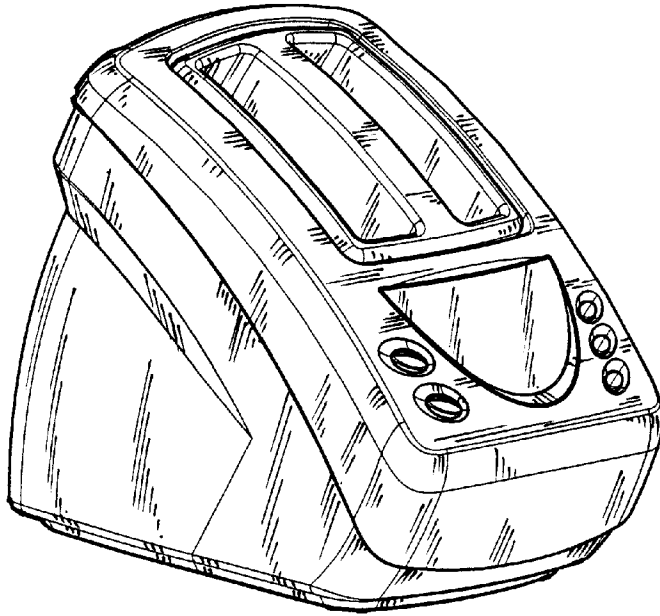

Fig 1

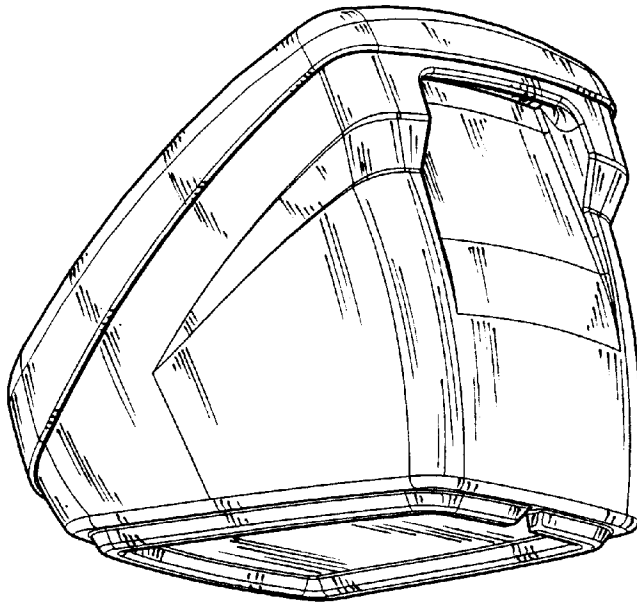

Fig 2

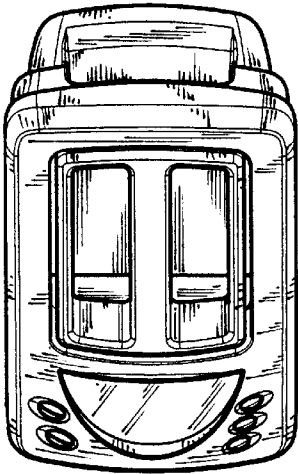

Fig 3

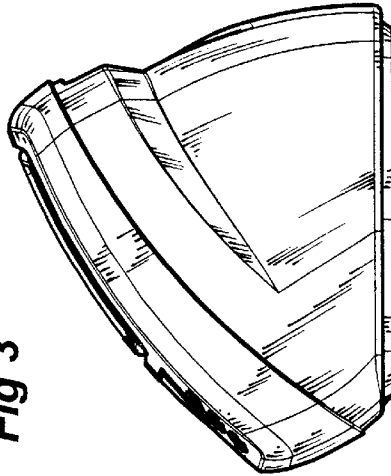

Fig 5

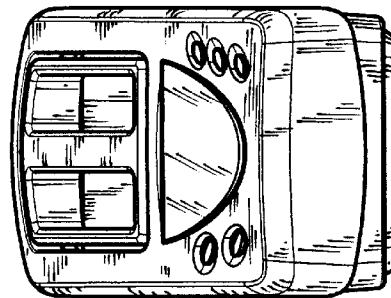

Fig 4

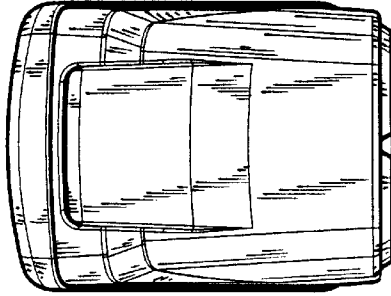

Fig 6

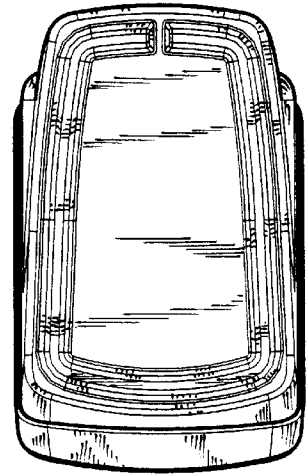

Fig 7