



US00D977073S

(12) **United States Design Patent**
Feng

(10) **Patent No.:** **US D977,073 S**

(45) **Date of Patent:** **** Jan. 31, 2023**

(54) **FAUCET KIT**

(71) Applicant: **Lijun Feng**, Suzhou (CN)

(72) Inventor: **Lijun Feng**, Suzhou (CN)

(**) Term: **15 Years**

(21) Appl. No.: **29/865,496**

(22) Filed: **Jul. 27, 2022**

(51) **LOC (14) Cl.** **23-01**

(52) **U.S. Cl.**
USPC **D23/238**

(58) **Field of Classification Search**
USPC D23/213, 214, 215, 223, 224, 226, 229,
D23/230, 238
CPC A61H 9/0021; A61H 33/00; B05B 1/00;
B05B 1/14; B05B 1/185; B05B 1/08;
B05B 1/02; B05B 1/26; B05B 12/002;
B05B 1/18; B05B 9/01
See application file for complete search history.

(56) **References Cited**

U.S. PATENT DOCUMENTS

D557,380	S	*	12/2007	Shieh	D23/238
D835,237	S	*	12/2018	Ziemann	D23/238
D835,238	S	*	12/2018	Ziemann	D23/238
D862,652	S	*	10/2019	Zeng	D23/238
D873,965	S		1/2020	Lazarini		
D917,014	S	*	4/2021	Wang	D23/238
D919,051	S	*	5/2021	Zeng	D23/238
D924,362	S	*	7/2021	Zhu	D23/238
D927,647	S	*	8/2021	Liang	D23/238
D930,118	S		9/2021	Elsner		
D931,416	S	*	9/2021	Chen	D23/238
D935,565	S	*	11/2021	Liu	D23/238
D946,119	S	*	3/2022	Levi	D23/238
D954,196	S	*	6/2022	Downey	D23/238
D964,520	S	*	9/2022	Kulig	D23/238

OTHER PUBLICATIONS

Owofan Kitchen Faucets Commercial Solid Brass Single Handle Single Lever Pull Down Sprayer, May 23, 2018, amazon.com, Sep. 21, 2022, URL: <https://www.amazon.com/dp/B07D8F5NCW/> (Year: 2018).*
Bathfinesse Kitchen Faucet with Pull Down Sprayer Faucet, Jun. 18, 2021, amazon.com, Sep. 21, 2022, URL: <https://www.amazon.com/dp/B094C3CH71/> (Year: 2021).*

(Continued)

Primary Examiner — Keith J Wilson

(57) **CLAIM**

The ornamental design for a faucet kit, as shown and described.

DESCRIPTION

FIG. 1 is a perspective view of a first component of a faucet kit, shown separately for ease of illustration; FIG. 2 is another perspective view thereof; FIG. 3 is a front elevational view thereof; FIG. 4 is a rear elevational view thereof; FIG. 5 is a left side elevational view thereof; FIG. 6 is a right side elevational view thereof; FIG. 7 is a top plan view thereof; FIG. 8 is a bottom plan view thereof; FIG. 9 is a perspective view of a second component of the faucet kit shown separately for ease of illustration; FIG. 10 is another perspective view thereof; FIG. 11 is a front elevational view thereof; FIG. 12 is a rear elevational view thereof; FIG. 13 is a left side elevational view thereof; FIG. 14 is a right side elevational view thereof; FIG. 15 is a top plan view thereof; and, FIG. 16 is a bottom plan view thereof.
The broken lines in the drawings depict portions of the faucet kit that form no part of the claimed design.

1 Claim, 16 Drawing Sheets

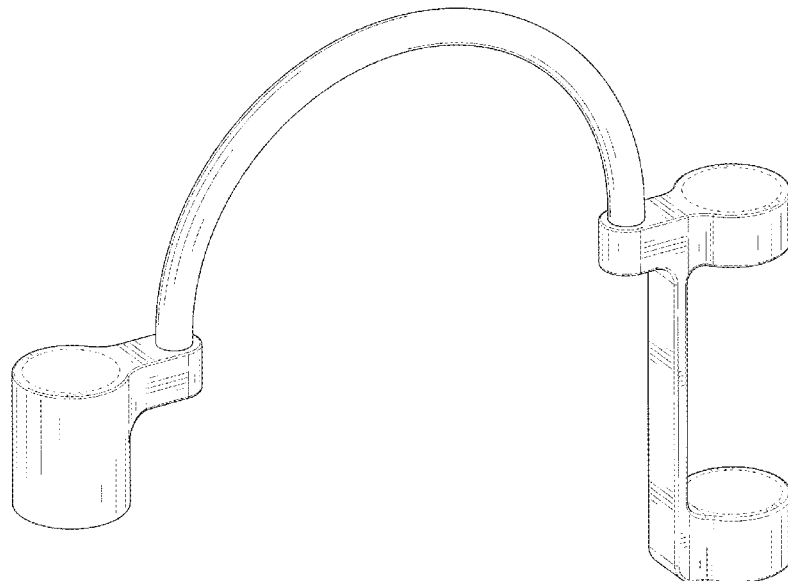

(56)

References Cited

OTHER PUBLICATIONS

BWE Black Kitchen Faucet with Pull Down Sprayer 3 Function, Mar. 9, 2022, amazon.com, Sep. 21, 2022, URL: <https://www.amazon.com/dp/B09FGG4JZF/> (Year: 2022).*

Delta Faucet Trinsic Pro Single-Handle Spring Spout Kitchen Sink Faucet, Aug. 23, 2016, amazon.ca, Oct. 6, 2022, URL: <https://www.amazon.ca/Delta-Faucet-9659-DST-Trinsic-Pull-Down/dp/B0U873OJY/> (Year: 2016).*

Forious Kitchen Faucet with Pull Down Sprayer, Sep. 15, 2020, amazon.ca, Oct. 6, 2022, URL: <https://www.amazon.ca/dp/B089SQ69KC/> (Year: 2020).*

Faustina 3 Way Kitchen Faucet with Drinking Water Faucet, Sep. 3, 2020, amazon.ca, Oct. 6, 2022, URL: <https://www.amazon.ca/Kitchen-Drinking-Stainless-Purifier-faustina/dp/B08GCLVTWP/> (Year: 2020).*

* cited by examiner

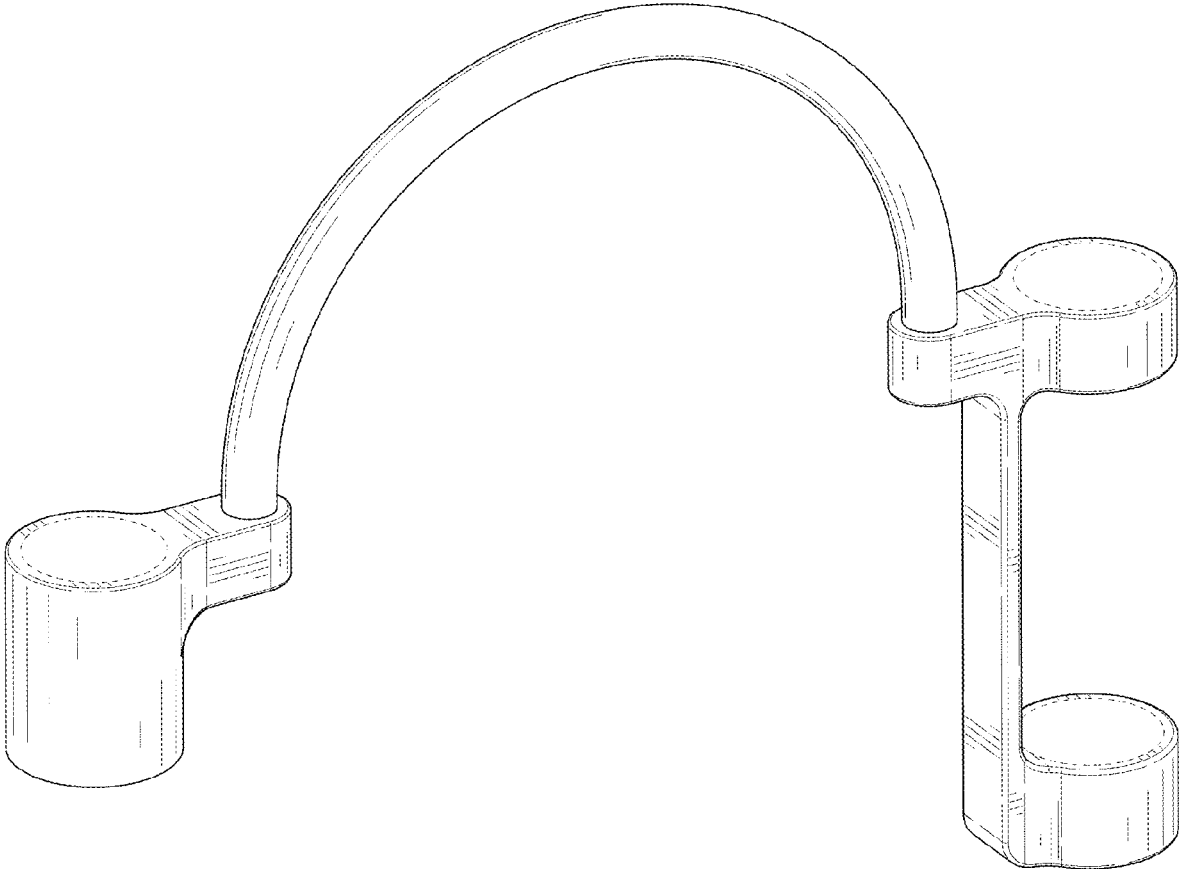

FIG. 1

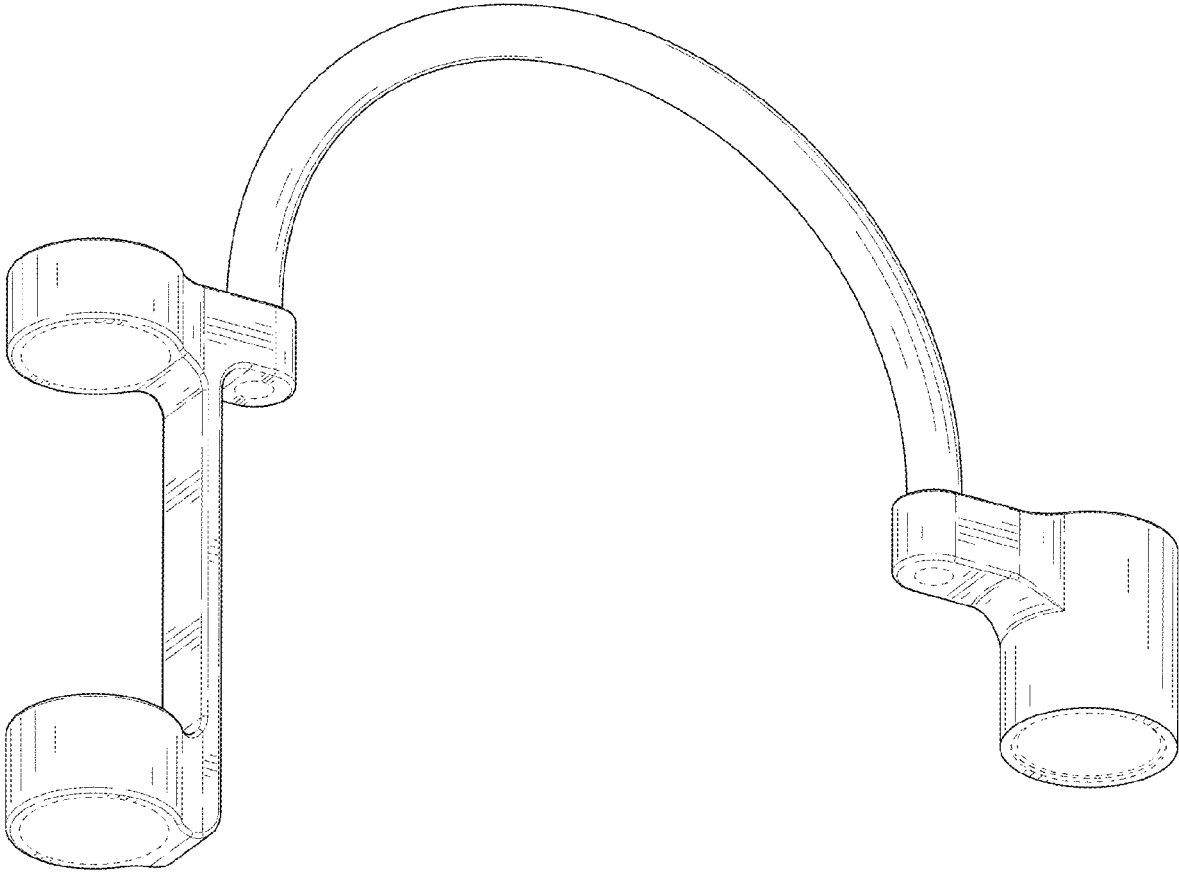

FIG. 2

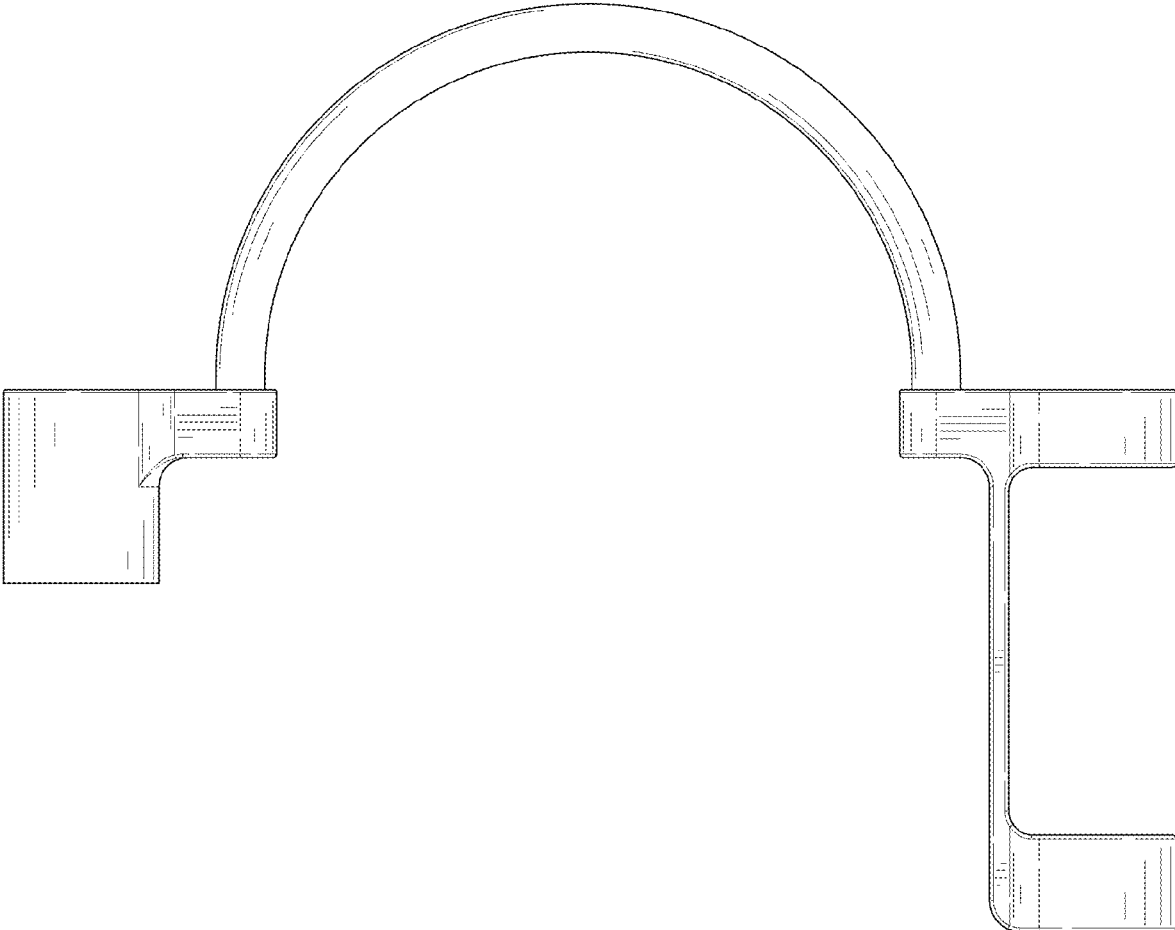

FIG. 3

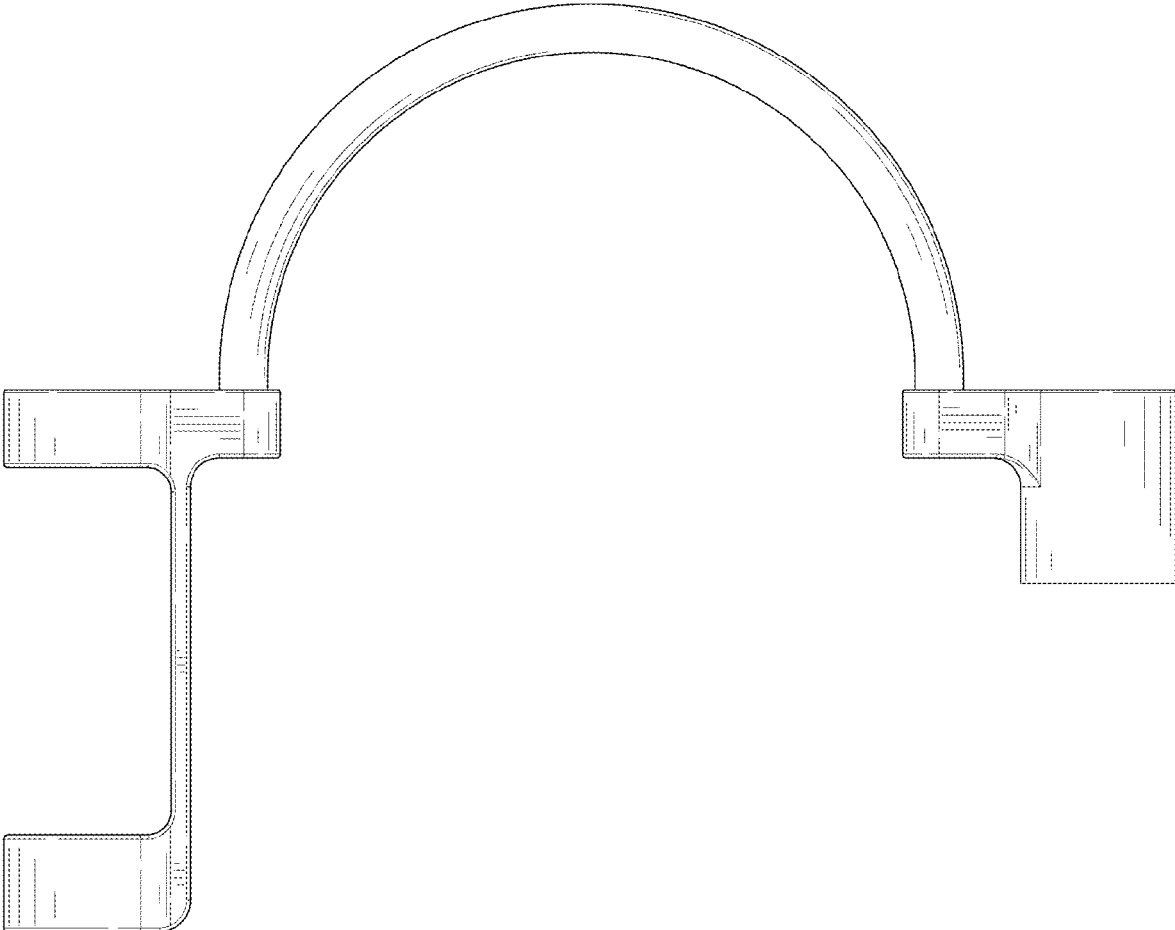

FIG. 4



FIG. 5

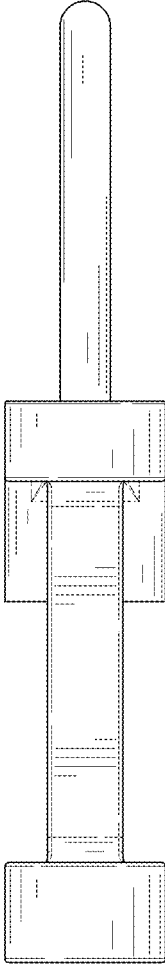

FIG. 6

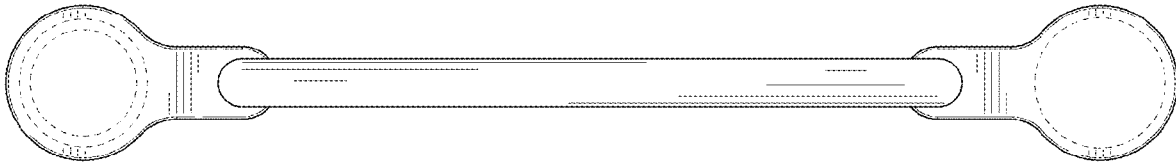

FIG. 7

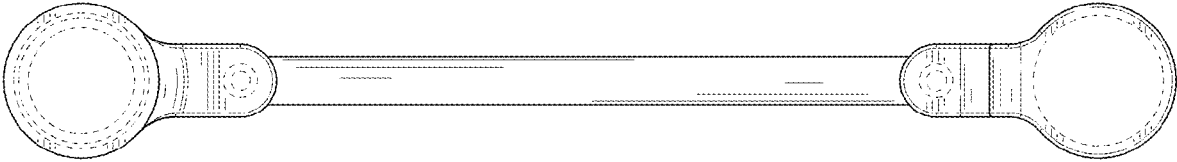

FIG. 8

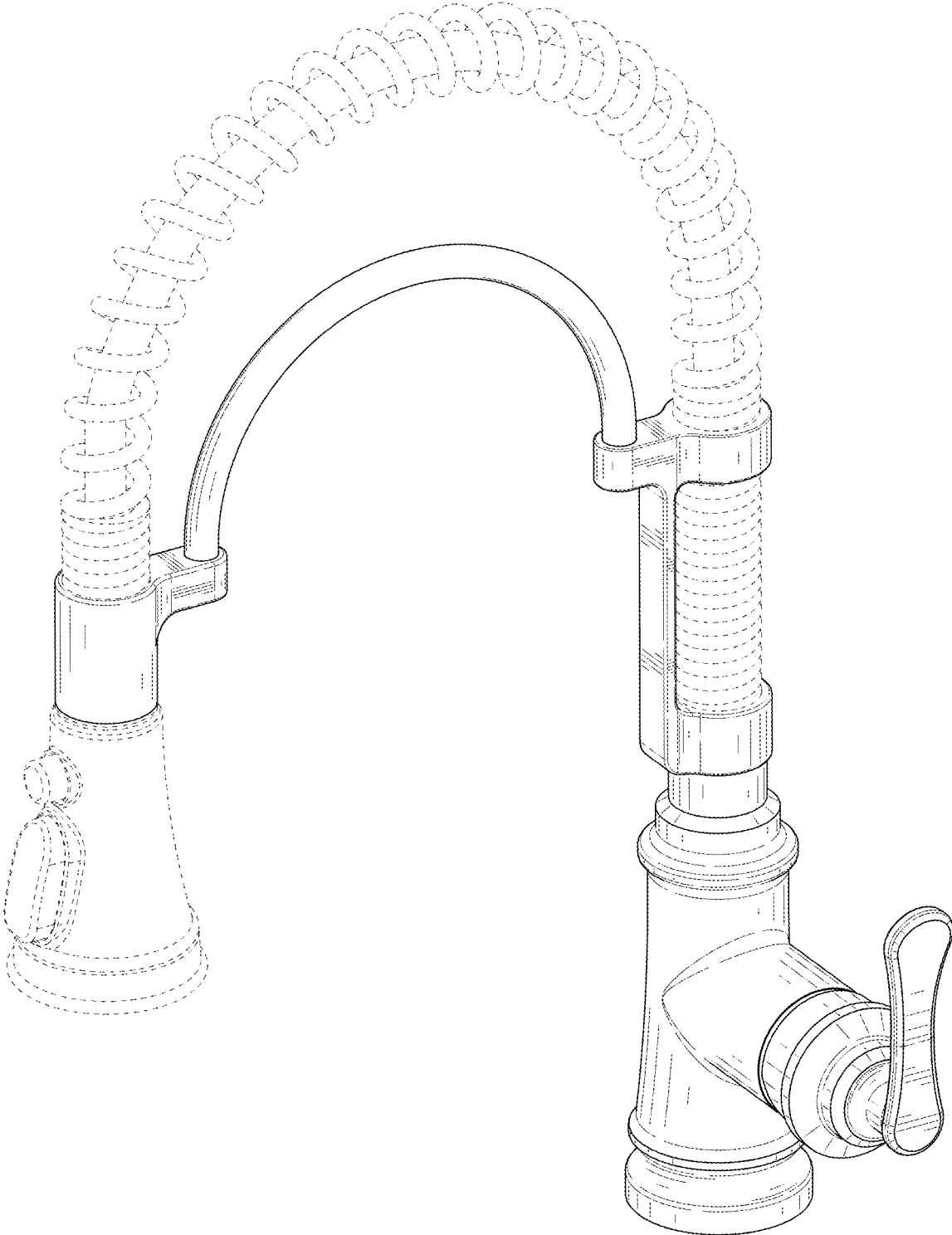

FIG. 9

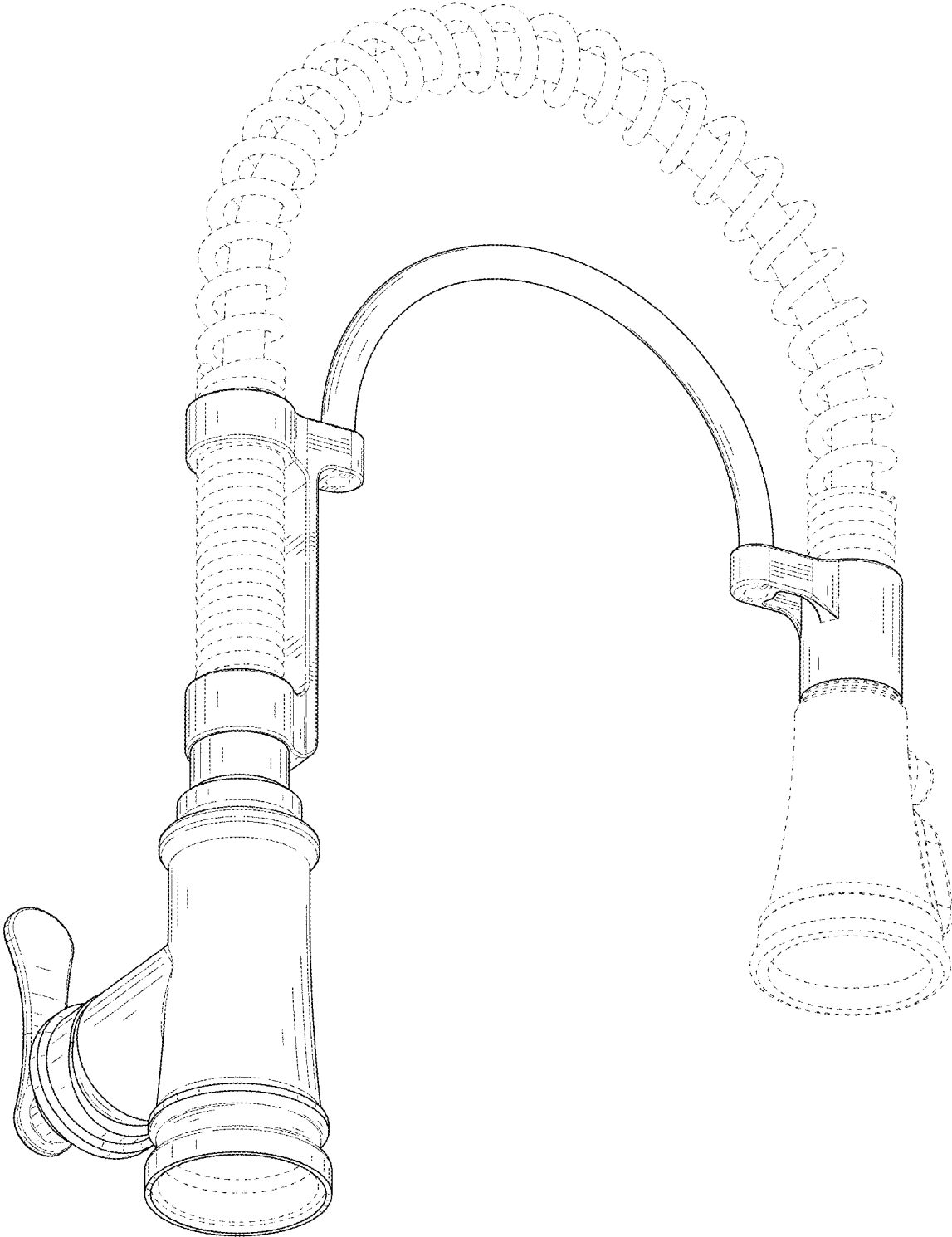

FIG. 10

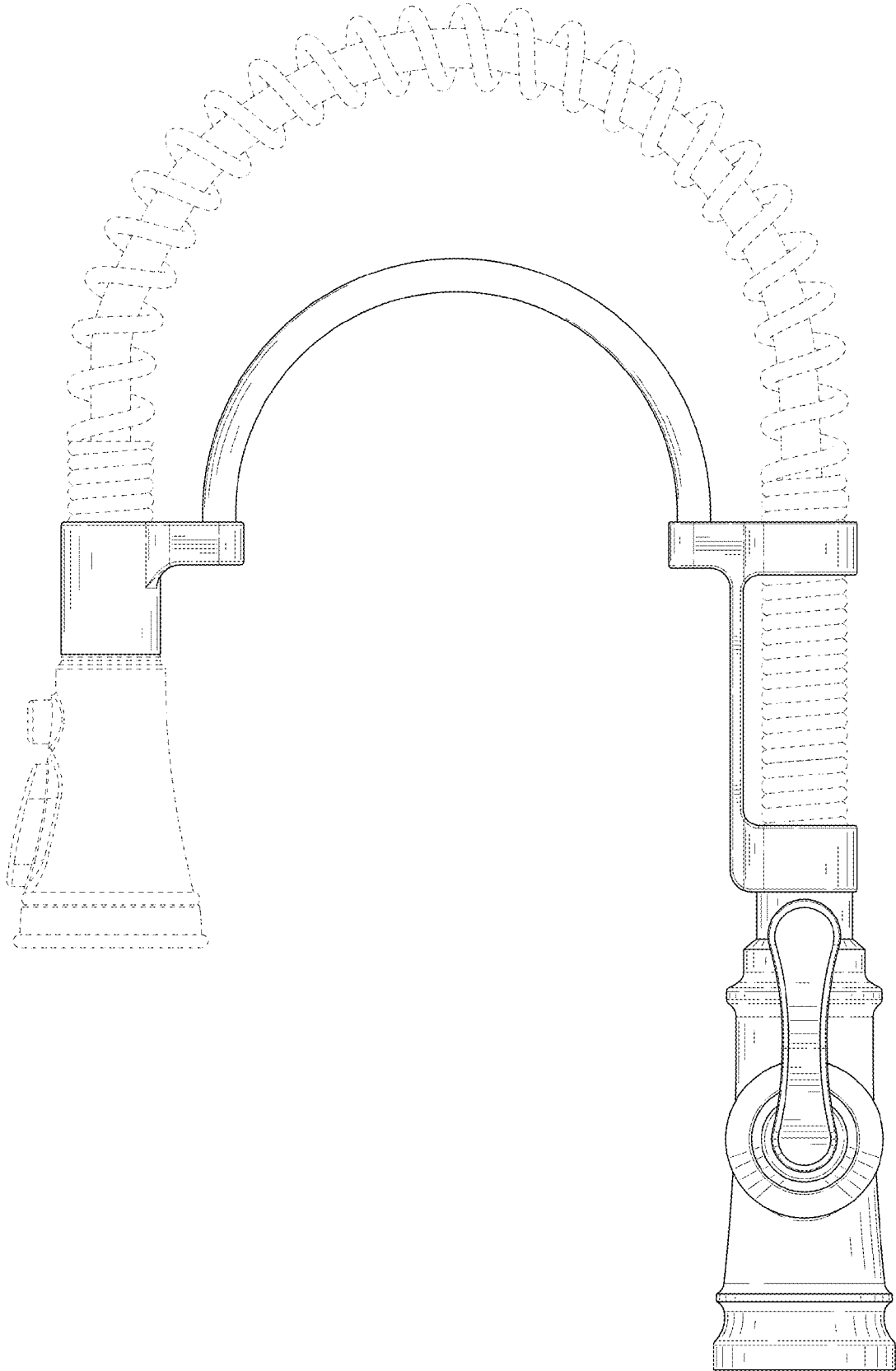

FIG. 11

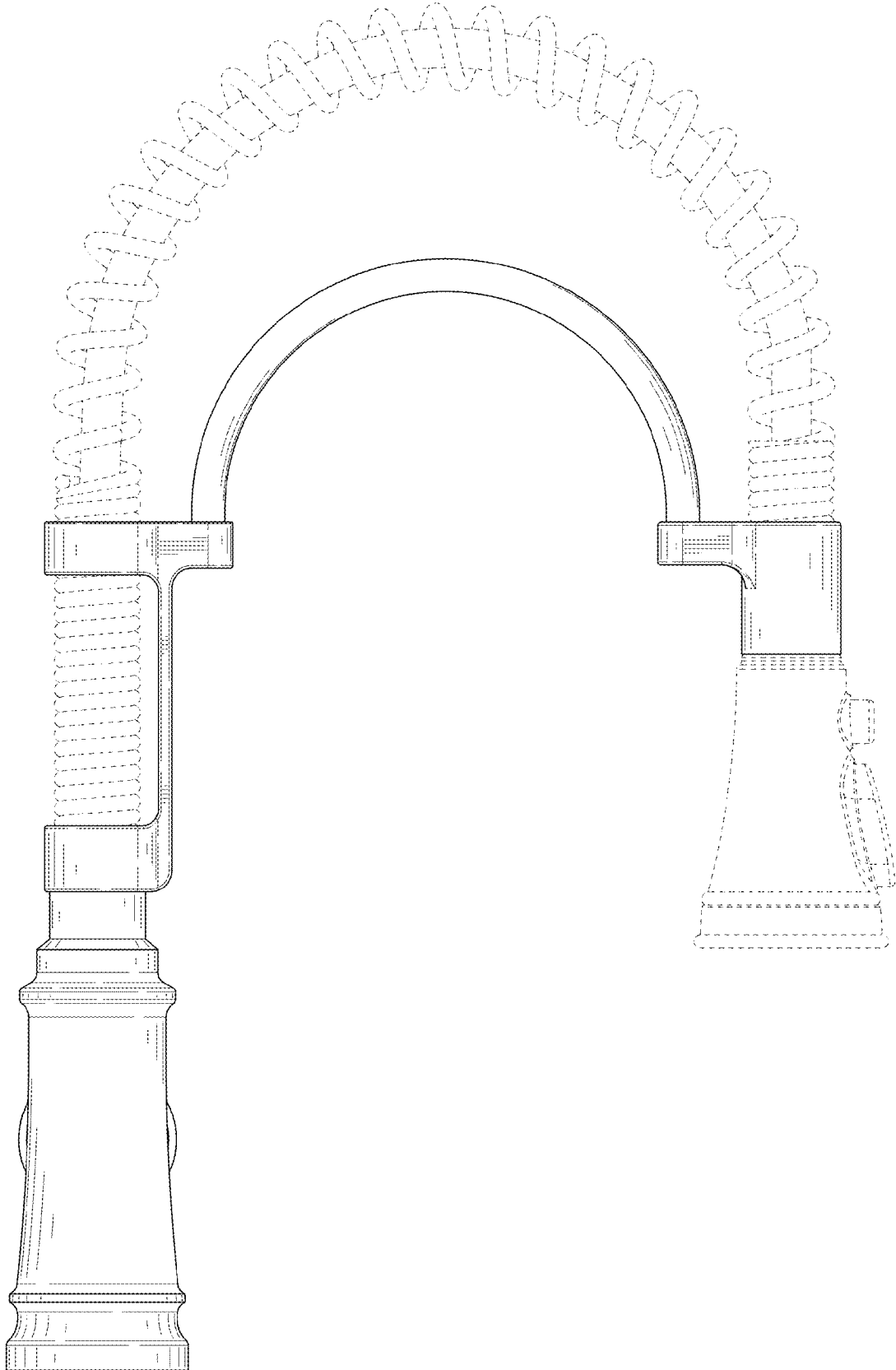

FIG. 12

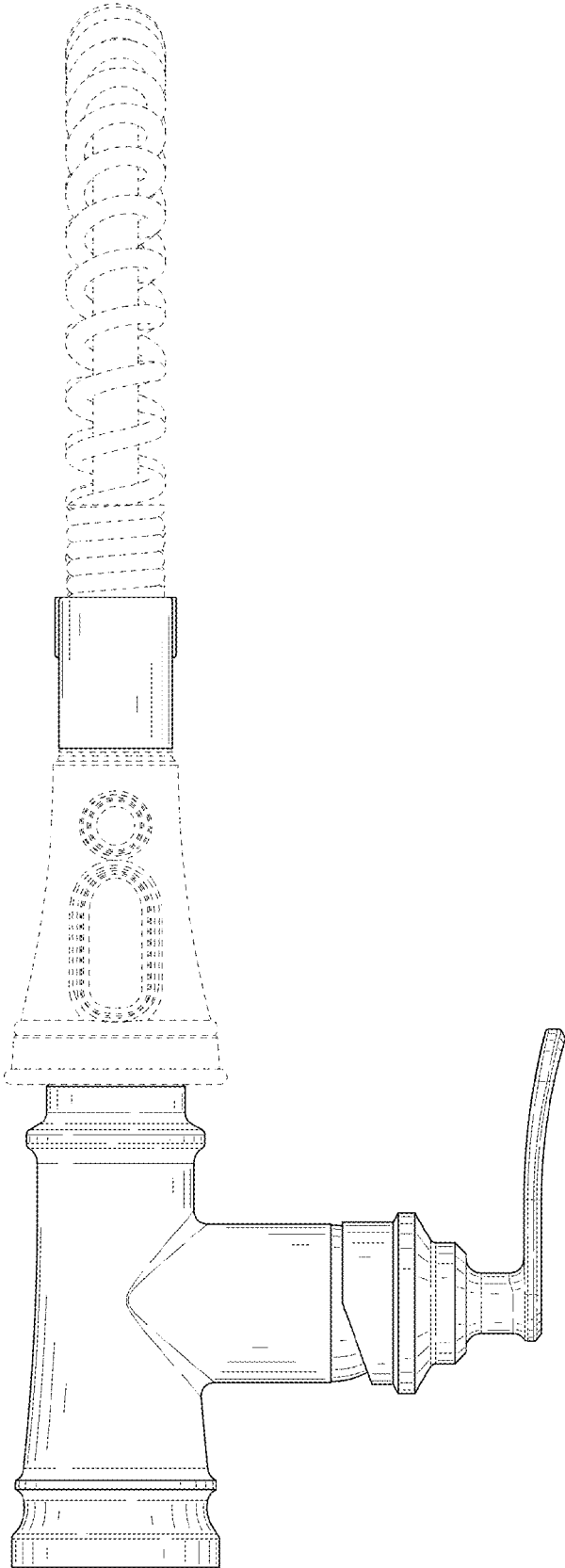

FIG. 13

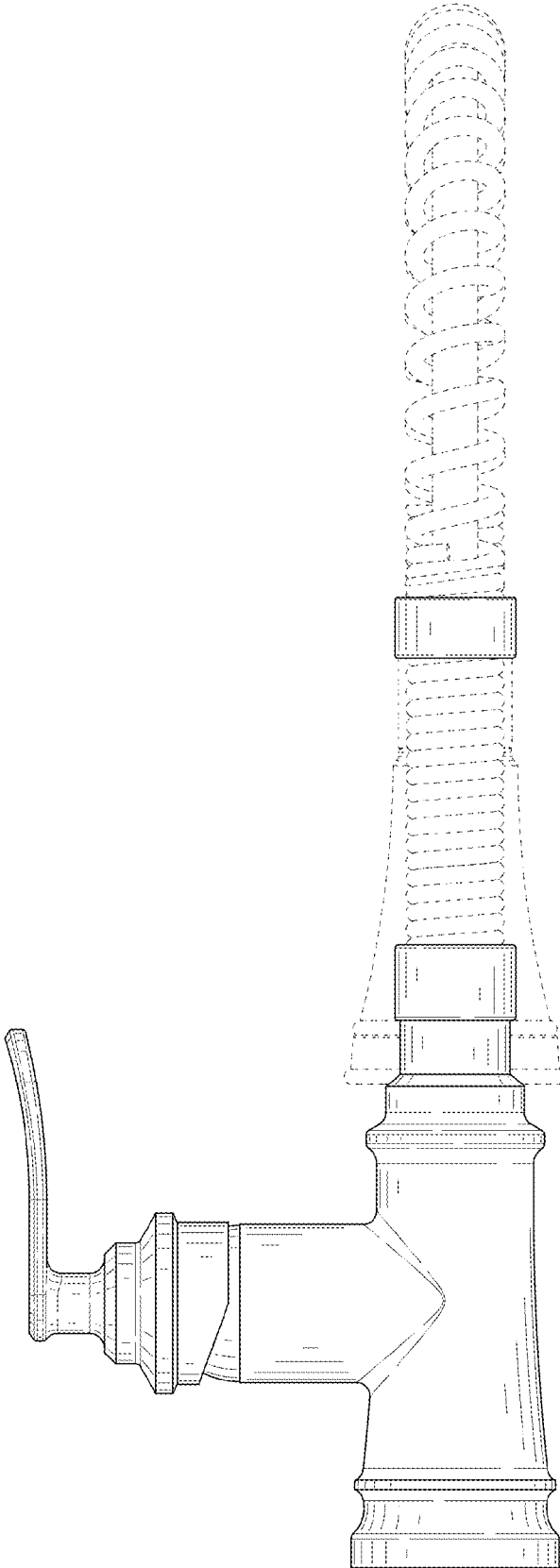

FIG. 14

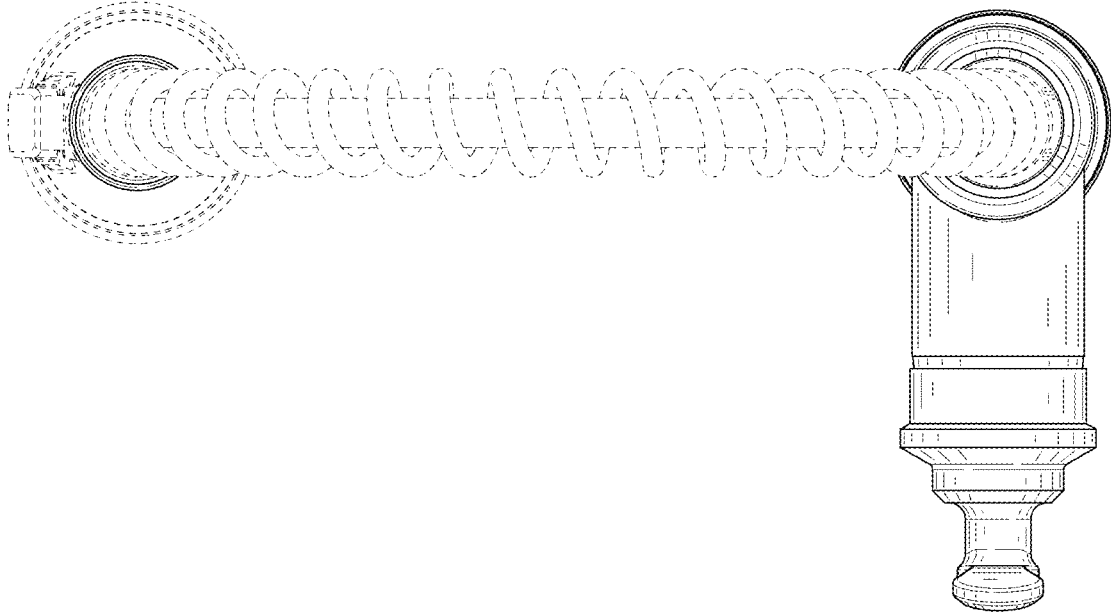

FIG. 15

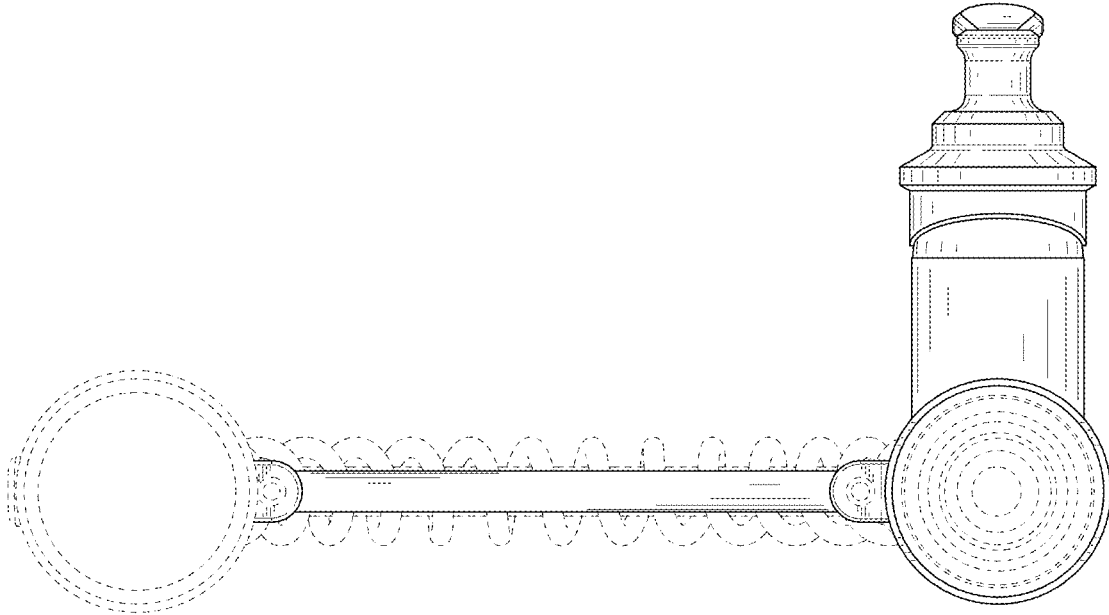

FIG. 16