



US00D598532S

(12) **United States Design Patent**
Dyson et al.

(10) **Patent No.:** **US D598,532 S**

(45) **Date of Patent:** **** Aug. 18, 2009**

(54) **FAN**

(75) Inventors: **James Dyson**, Malmesbury (GB); **Peter David Gammack**, Malmesbury (GB); **Tom Vallance Hamilton Crawford**, Malmesbury (GB)

(73) Assignee: **Dyson Limited**, Wiltshire (GB)

(**) Term: **14 Years**

(21) Appl. No.: **29/331,015**

(22) Filed: **Jan. 16, 2009**

(30) **Foreign Application Priority Data**

Jul. 19, 2008 (GB) 4008394

(51) **LOC (9) Cl.** **23-04**

(52) **U.S. Cl.** **D23/370**

(58) **Field of Classification Search** D23/382,
D23/381, 370, 413, 411, 412; 416/244 R,
416/246, 247 R; D6/309

See application file for complete search history.

(56) **References Cited**

U.S. PATENT DOCUMENTS

D539,414 S * 3/2007 Russak et al. D23/411

* cited by examiner

Primary Examiner—Lisa P Lichtenstein

(74) *Attorney, Agent, or Firm*—Morrison & Foerster LLP

(57) **CLAIM**

We claim the ornamental design for a fan, as shown and described.

DESCRIPTION

FIG. 1 is a front perspective view of a fan showing our new design;

FIG. 2 is a rear perspective view thereof;

FIG. 3 is a rear view thereof;

FIG. 4 is a front view thereof;

FIG. 5 is a side view thereof;

FIG. 6 is a side view from the opposite side of FIG. 5;

FIG. 7 is a top plan view thereof; and,

FIG. 8 is an underneath plan view thereof.

The features of the design as claimed by applicants are shown in bold lines. The features shown in dotted lines are not claimed and are provided to indicate the context of the design.

1 Claim, 7 Drawing Sheets

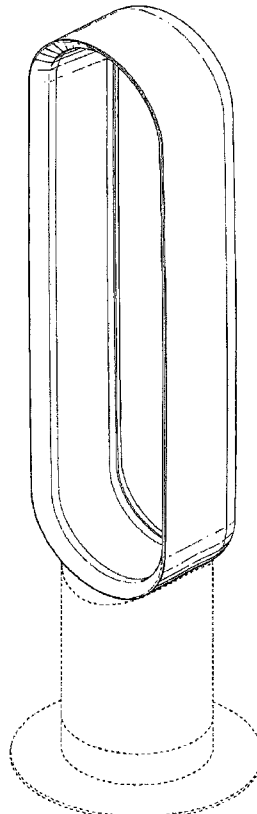

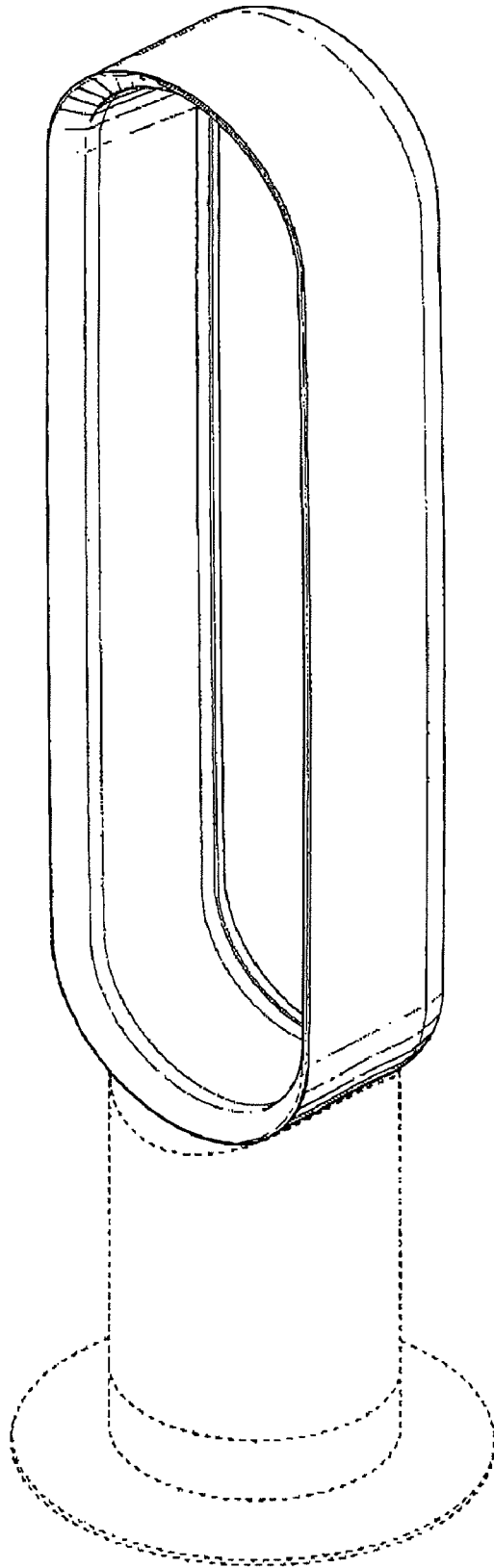

FIG. 1

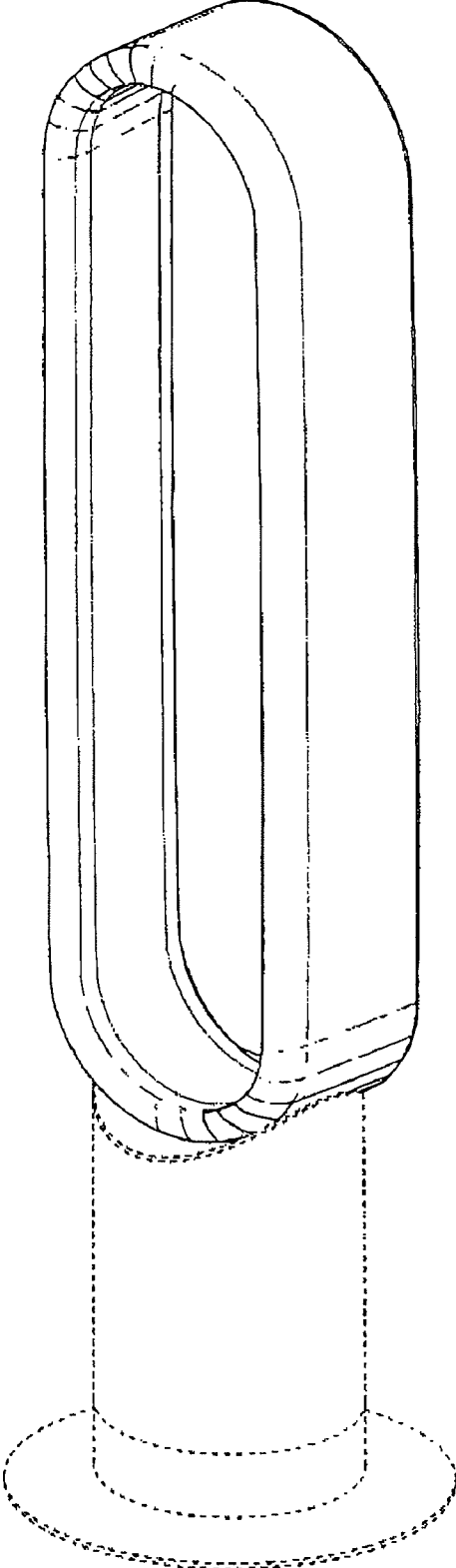

FIG. 2

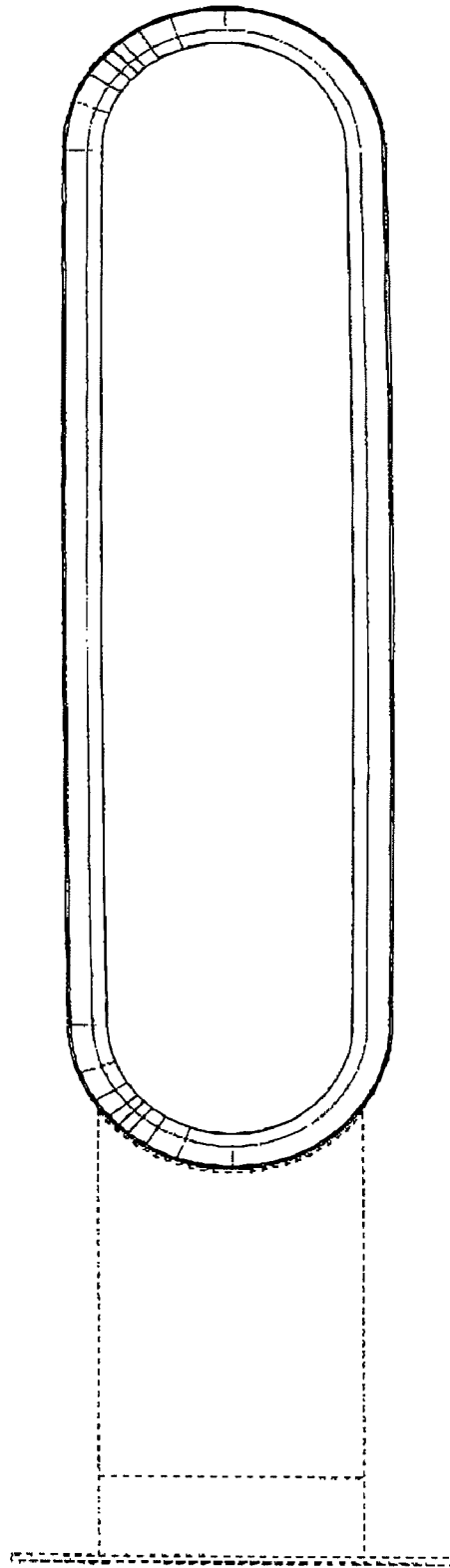

FIG. 3

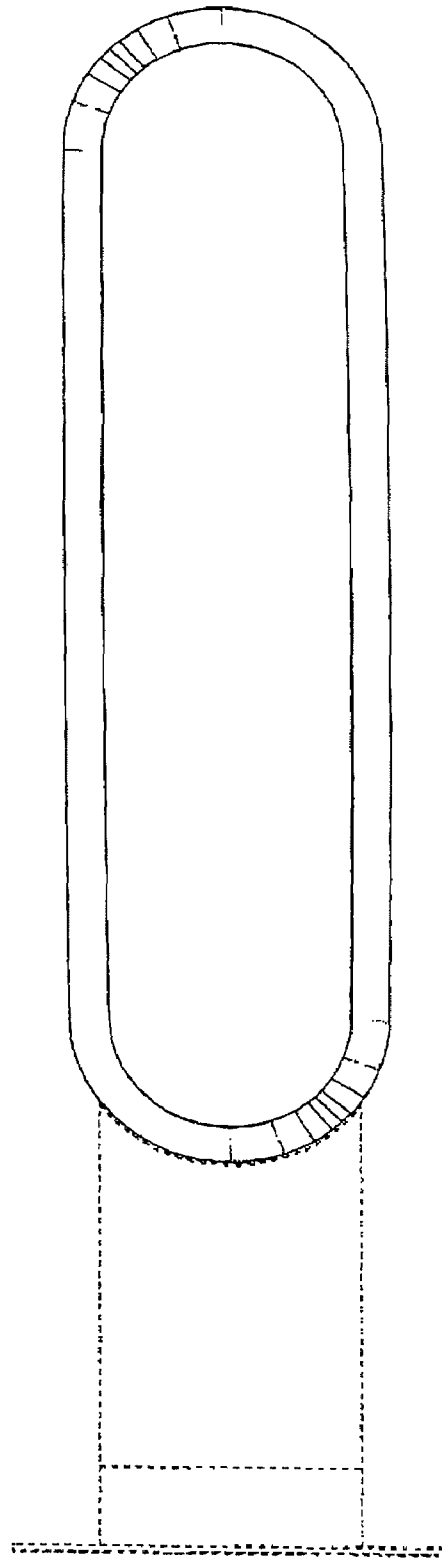

FIG. 4

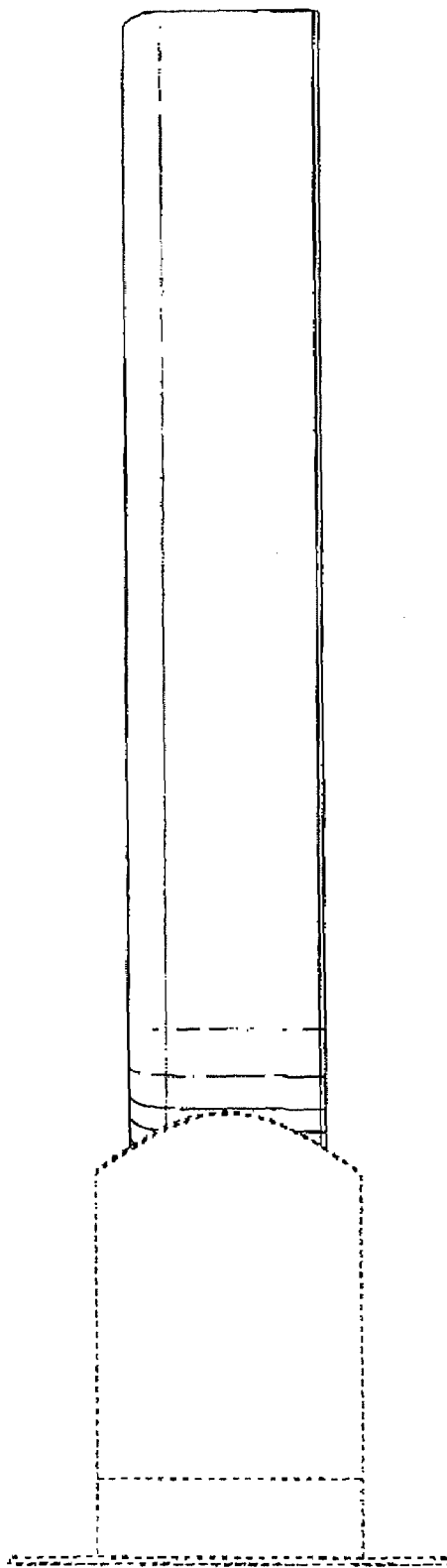

FIG. 5

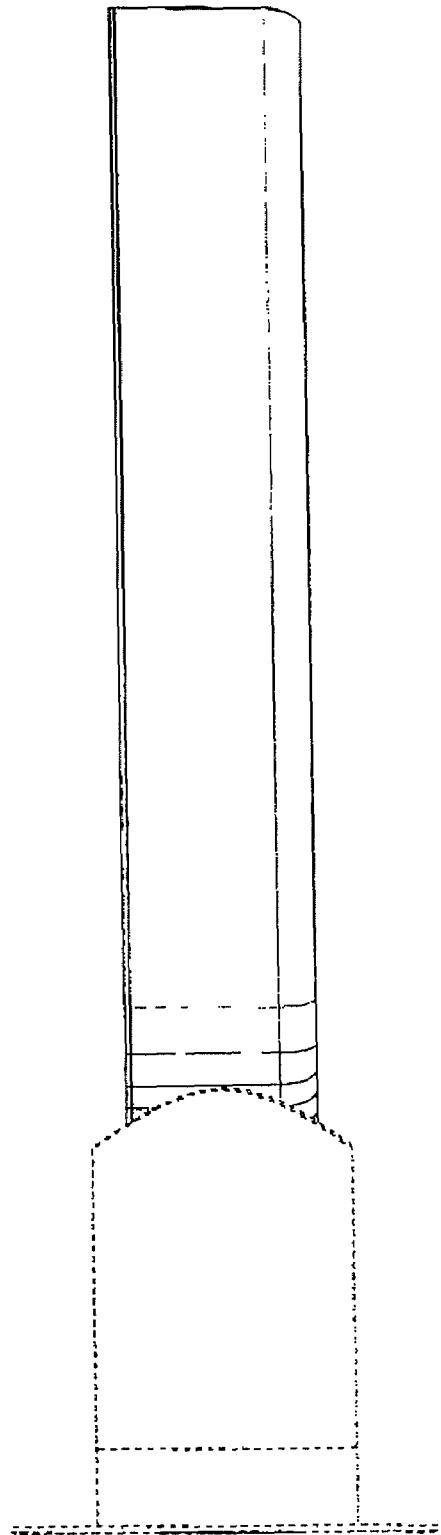

FIG. 6

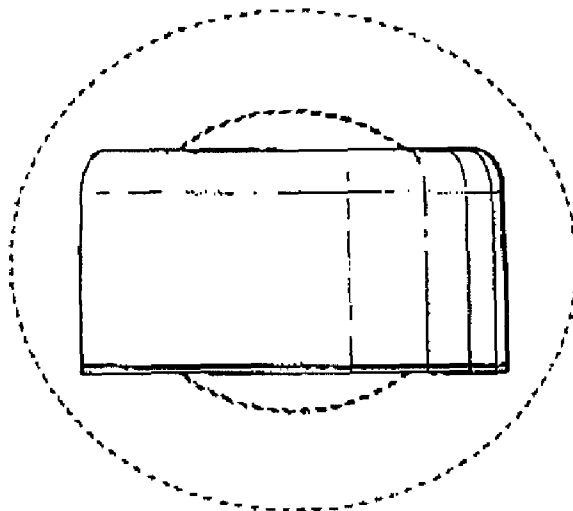

FIG. 7

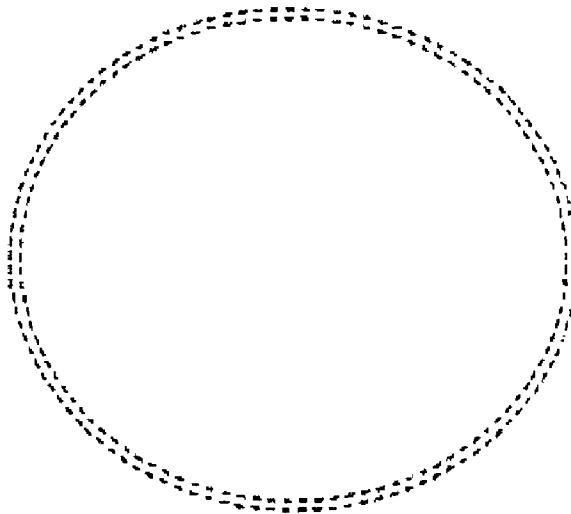

FIG. 8