

(12) INTERNATIONAL APPLICATION PUBLISHED UNDER THE PATENT COOPERATION TREATY (PCT)

(19) World Intellectual Property Organization
International Bureau



(43) International Publication Date
1 July 2010 (01.07.2010)

PCT

(10) International Publication Number
WO 2010/071989 A1

- (51) **International Patent Classification:**
C10G 2/00 (2006.01) C10L 1/08 (2006.01)
C07C 1/04 (2006.01)
- (21) **International Application Number:**
PCT/CA2009/001862
- (22) **International Filing Date:**
21 December 2009 (21.12.2009)
- (25) **Filing Language:** English
- (26) **Publication Language:** English
- (30) **Priority Data:**
12/318,106 22 December 2008 (22.12.2008) US
PCT/CA2008/002306
22 December 2008 (22.12.2008) CA
- (71) **Applicant (for all designated States except US):** CANADA CHEMICAL CORPORATION [CA/CA]; Bay 3, 4500•5th Avenue N.E., Calgary, Alberta T2E 7C3 (CA).
- (72) **Inventor; and**
- (75) **Inventor/Applicant (for US only):** AYASSE, Conrad [CA/CA]; 3931 Point McKay Road N.W., Calgary, Alberta T3B 4V7 (CA).
- (74) **Agent:** GOWLING LAFLEUR HENDERSON LLP; 700 - 2nd Street, S.W., Suite 1400, Sootia Centre, Calgary, Alberta T2P 4V5 (CA).
- (81) **Designated States (unless otherwise indicated, for every kind of national protection available):** AE, AG, AL, AM, AO, AT, AU, AZ, BA, BB, BG, BH, BR, BW, BY, BZ, CA, CH, CL, CN, CO, CR, CU, CZ, DE, DK, DM, DO, DZ, EC, EE, EG, ES, FI, GB, GD, GE, GH, GM, GT, HN, HR, HU, ID, IL, IN, IS, JP, KE, KG, KM, KN, KP, KR, KZ, LA, LC, LK, LR, LS, LT, LU, LY, MA, MD, ME, MG, MK, MN, MW, MX, MY, MZ, NA, NG, NI, NO, NZ, OM, PE, PG, PH, PL, PT, RO, RS, RU, SC, SD, SE, SG, SK, SL, SM, ST, SV, SY, TJ, TM, TN, TR, TT, TZ, UA, UG, US, UZ, VC, VN, ZA, ZM, ZW.
- (84) **Designated States (unless otherwise indicated, for every kind of regional protection available):** ARIPO (BW, GH, GM, KE, LS, MW, MZ, NA, SD, SL, SZ, TZ, UG, ZM, ZW), Eurasian (AM, AZ, BY, KG, KZ, MD, RU, TJ, TM), European (AT, BE, BG, CH, CY, CZ, DE, DK, EE, ES, FI, FR, GB, GR, HR, HU, IE, IS, IT, LT, LU, LV, MC, MK, MT, NL, NO, PL, PT, RO, SE, SI, SK, SM, TR), OAPI (BF, BJ, CF, CG, CI, CM, GA, GN, GQ, GW, ML, MR, NE, SN, TD, TG).
- Published:**
— with international search report (Art. 21(3))
— with amended claims (Art. 19(1))



WO 2010/071989 A1

(54) **Title:** LOW-PRESSURE FISCHER-TROPSCH PROCESS

(57) **Abstract:** A Fischer-Tropsch process for producing diesel fuel or diesel blending stock with a high cetane number, in a concentration of 65-90wt% at pressures below 200 psia, using a cobalt catalyst with a rhenium and/or ruthenium promoter. The catalyst is a cobalt catalyst with crystallites having an average diameter greater than 16 nanometers, and the resulting hydrocarbon product after a rough flash, contains less than 10wt% waxes (>C₂₃).

LOW-PRESSURE FISCHER-TROPSCH PROCESS

Field of the Invention

5

This invention relates generally to a low pressure Fischer-Tropsch process for converting carbon monoxide and hydrogen to diesel fuel or diesel blending stock.

Background of the Invention

10

The Fischer-Tropsch (FT) process for converting carbon monoxide and hydrogen to liquid motor fuels and/or wax has been known since the 1920's.

During the Second World War synthetic diesel was manufactured in Germany using coal gasification to supply a 1:1 ratio of hydrogen and carbon monoxide for conversion to fuel hydrocarbons. Because of trade sanctions and the paucity of natural gas, South Africa further developed the coal via gasification route to synthesis gas and employed a fixed-bed iron Fischer-Tropsch catalyst. Iron catalysts are very active for the water-gas shift reaction which moves the gas composition from a deficiency of hydrogen and closer to the optimum H₂/CO ratio of around 2.0. When large natural gas supplies were developed, steam and autothermal reformers were employed to produce the synthesis gas feedstock to slurry-bed FT reactors using cobalt or iron catalysts.

In Gas-To-Liquids (GTL) plants, compromises must be made between liquid product yield and plant operating and capital costs. For example, if there is a market for electricity, a steam reformer design may be chosen because this technology produces a large amount of waste heat: flue gas heat can be converted to electricity using an 'economiser' and steam turbine. If conservation of natural gas feedstock and low capital cost are paramount, autothermal or partial oxidation reformers using air are favored.

Another factor in selecting the best reformer type is the nature of the reformer hydrocarbon feed gas. If the gas is rich in CO₂, this can be advantageous because the desired H₂/CO ratio can then be achieved directly in the reformer gas without the need to remove excess hydrogen, and some of the CO₂ is converted to CO, increasing the potential volume of liquid hydrocarbon product that can be produced. Additionally, the volume of steam that is required is reduced, which reduces the process energy requirements,

The market for Fischer-Tropsch (FT) processes is concentrated on large "World-Scale" plants with natural gas feed rates of greater than 200 million scfd because of the considerable economies of scale. These plants operate at high-pressure, about 450 psia, and use extensive recycling of tail gas in the FT reactor. For, example, the Norsk Hydro plant design has a recycle ratio of about 3.0. The emphasis is on achieving the maximum wax yield. In terms of product slate, these large plants strive for the maximum yield of FT waxes in order to minimize the formation of C₁-C₅ products. The waxes are then hydrocracked to primarily diesel and naphtha fractions. Unfortunately, light hydrocarbons are also formed in this process. The reformers usually use some form of autothermal reforming with oxygen that is produced cryogenically from air, an expensive process in terms of operating cost and capital cost. The economies of scale justify the use of high operating pressure, the use of oxygen natural gas reforming, extensive tail gas recycling to the FT reactor for increasing synthesis gas conversion and controlling heat removal and product wax hydrocracking. To date, an economical FT plant design has not been developed for small plants with capacities of less than 100 million scfd.

The catalytic hydrogenation of carbon monoxide to produce a variety of products ranging from methane to heavy hydrocarbons (up to C₈₀ and higher) as well as oxygenated hydrocarbons is usually referred to as Fischer-Tropsch synthesis. The high molecular weight hydrocarbon product primarily comprises normal paraffins which cannot be used directly as motor fuels because their cold properties are not compatible. After further hydroprocessing, Fischer-Tropsch hydrocarbon products can be transformed into products with a higher added value such as diesel, jet fuel or

kerosene. Consequently, it is desirable to maximize the production of high value liquid hydrocarbons directly so that component separation or hydrocracking are not necessary.

5 Catalytically active group VIII, in particular, iron, cobalt and nickel are used as Fischer-Tropsch catalysts; cobalt/ruthenium is one of the most common catalyzing systems. Further, the catalyst usually contains a support or carrier metal as well as a promoter, e.g., rhenium.

10

Summary of the Invention

According to one aspect of the invention, there is provided Fischer-Tropsch
15 (FT) process having a cobalt catalyst with crystallites, wherein the crystallites have an average diameter greater than 16 nanometers. The process produces a liquid hydrocarbon product containing less than 10 weight percent wax ($>C_{23}$) and greater than 65% diesel (C_9-C_{23}). The process can have a FT catalyst support for the cobalt catalyst, wherein the catalyst support is selected from the group of catalyst supports
20 consisting of alumina, zirconia, titania and silica. The cobalt catalyst can have a catalyst loading that is greater than 10 weight %. The operating pressure for the Fischer-Tropsch process can be less than 200 psia. Promoters can be utilized in this process, in which case the promoters are selected from the group consisting of : ruthenium, rhenium, rhodium, nickel, zirconium, titanium, and mixtures thereof. A
25 flash distillation can be conducted on the process to reduce the naphtha cut. The process can use a FT reactor that does not use tailgas recycle. The process can also use a reformer that uses air as an oxygen source. The reactor can be a fixed-bed FT reactor or a slurry bubble bed FT reactor.

30 According to another aspect of the invention, there is provided a FT process operating at less than 200 psia, using an air autothermal reformer, and having a CO conversion of at least 65 % and providing a diesel yield greater than 60% by weight in a single- pass FT reactor using a cobalt catalyst. The catalyst has a metallic cobalt

loading greater than 5% by weight and rhenium loading of less than 2% by weight on a catalyst support material selected from the group of catalyst support materials comprising alumina, zirconia, and silica. The cobalt catalyst is in the form of crystallites, wherein the crystallites have an average diameter greater than 16
5 nanometers. The FT catalyst support material can be comprised of alumina. This process can have a feed gas, wherein selective membranes or molecular sieves are employed to remove hydrogen from the feed gas. Alternatively, the cobalt catalyst loading can be greater than 6 weight % and operating pressure can be less than 100 psia. The reactor can further have a promoter, wherein said promoter comprises a
10 promoter selected from the group of promoters consisting of ruthenium and rhenium or mixtures thereof.

According to yet another aspect of the invention, there is provided a FT process operating at less than 200 psia, using an oxygen autothermal reformer, and
15 having a CO conversion of at least 65 % and providing a diesel yield greater than 60% by weight in a FT reactor using a cobalt catalyst. The catalyst has a metallic cobalt loading greater than 5% by weight and a rhenium loading of less than 2% by weight on a catalyst support selected from the group of catalyst supports comprised of alumina, zirconia and silica materials. The cobalt catalyst is in the form of crystallites,
20 said crystallites having an average diameter greater than 16 nanometers. The FT catalyst support can be comprised of alumina. The process can include a tailgas from the reformer, wherein the tailgas is partially recycled to the reformer. The process can also include a feed gas wherein selective membranes or molecular sieves are employed to remove hydrogen from the gas. Alternatively, the cobalt catalyst loading
25 can be greater than 6 weight % and the operating pressure can be less than 100 psia. The reactor can further have a promoter, wherein said promoter comprises a promoter selected from the group of promoters consisting of ruthenium or rhenium, or mixtures thereof

30 According to yet another aspect of the invention, there is provided a FT process operating at less than 200 psia, using an oxygen steam reformer, and having a CO conversion of at least 65 % and providing a diesel yield greater than 60% in by

weight in a FT reactor using a cobalt catalyst with a metallic cobalt loading greater than 5% by weight and rhenium loading of less than 2% by weight on a catalyst support selected from the group of catalyst supports comprised of alumina, zirconia, or silica materials, or mixtures thereof. The cobalt catalyst is in the form of
5 crystallites, wherein the crystallites have an average diameter greater than 16 nanometers. The FT catalyst support can be comprised of alumina. The process can include a feed gas, wherein selective membranes or molecular sieves are employed to remove hydrogen from the feed gas. The process can further include a tailgas from the reformer, wherein some or all of the tailgas is burned to provide heat to the
10 reformer. Alternatively, the cobalt catalyst loading can be greater than 6 weight % and the operating pressure can be less than 100 psia. The reactor can further have a promoter, wherein said promoter comprises a promoter selected from the group of promoters consisting of ruthenium or rhenium, or mixtures thereof.

15 According to yet another aspect of the invention, there is provided a FT process operating at less than 200 psia, using an air or oxygen partial oxidation reformer, and having a CO conversion of greater than 65 % and providing a diesel yield greater than 60% by weight in a FT reactor using a cobalt catalyst with a metallic cobalt loading greater than 5% by weight and rhenium loading of less than
20 2% by weight on a FT catalyst support selected from the group of catalyst supports comprising alumina, zirconia, and silica materials. The cobalt catalyst is in the form of crystallites, and the crystallites have an average diameter greater than 16 nanometers. The FT catalyst support can be comprised of alumina. The process can include a feed gas, wherein selective membranes or molecular sieves are employed to
25 remove hydrogen from the feed gas. The process can further include a tailgas from the reformer, wherein some or all of the tailgas is burned to provide heat to the reformer. Alternatively, the cobalt catalyst loading can be greater than 6 weight % and the operating pressure can be less than 100 psia. The reactor can further have a promoter, wherein said promoter comprises a promoter selected from the group of
30 promoters consisting of ruthenium or rhenium, or mixtures thereof.

Brief Description of the Drawings

- Figure 1** is a process flow diagram for a particular embodiment of the invention;
- 5 **Figure 2** is a flow diagram for flash separation of naphtha and diesel hydrocarbon fractions as a subsequent step to the Fischer-Tropsch process;
- Figure 3** is a graph showing C5+ carbon number distribution for the catalyst of Example 3 (trilobes) at 190 °C;
- 10 **Figure 4** is a graph showing the effect of pressure on the performance of the catalyst of Example 4;
- Figure 5** is a graph of C5+ carbon number distribution of the catalyst of Example 7 at
- 15 190°C, 70 psia;
- Figure 6** is a graph of the C5+ carbon number distribution for the catalyst of Example 8a (LD-5) at 200°C, 70 psia;
- 20 **Figure 7** is a graph of the C5+ carbon number distribution for the catalyst of Example 9 (F-220) at 190 °C., 70 psia
- Figure 8** is a graph of the C5+ carbon number distribution for the catalyst of Example 10 using a Ruthenium promoter;
- 25 **Figure 9** is a graph of the C5+ carbon number distribution for Catalyst of Example 11 (Aerolyst 3038 silica);
- Figure 10** is a graph showing the relationship of cobalt catalyst crystallite size to wax
- 30 content of a C5+ FT product; and
- Figure 11** is a graph showing a comparison of catalyst used in Example 9 carbon distribution with a traditional Anderson-Shultz-Flory distribution.

* In all Figures showing graphs of carbon numbers, naphtha is indicated by large squares, diesel by diamonds and light waxes by small squares.

5

Detailed Description of Embodiments of the Invention

Introduction

In Fischer-Tropsch processes, various parameters such as the size and shape of cobalt crystallites affect the activity of cobalt supported catalysts. The size of metal
10 crystallites controls the number of active sites available for reduction (dispersion) and degree of reduction.

Under certain pretreatment and activation conditions, a strong interaction
15 between cobalt metal and oxide supports forms undesirable cobalt-support structures, for example, cobalt aluminate, which may require high reduction temperature. High reduction temperature can result in sintering cobalt crystallites and forming large cobalt metal clusters. Not only temperature treatments, but also cobalt metal precursors and metal loading, as well as metal promoters affect the size of cobalt
20 crystallites. Low cobalt metal loading could result in high metal dispersion and small crystallites but enhances the metal-support interaction leading to poor reducibility and low catalyst activity.

Hydrogenation of carbon monoxide using cobalt-supported catalyst is directly
25 proportional to the amount of exposed cobalt atoms. Therefore, increasing cobalt metal dispersion on the oxide support surface, logically, enhances the catalyst activity and C5+ selectivity. However, small cobalt crystallites strongly interact with the oxide support forming unreducible cobalt-support systems. The strong correlation between cobalt metal crystallites and reducibility influences the catalyst activity and
30 may produce undesirable products. Under typical Fischer-Tropsch reaction conditions cobalt crystallite size range (9-200 nm) and dispersion range (11-0.5 %) have minor influence on C5+ selectivity. Nevertheless, smaller cobalt crystallites

suffer from serious deactivation. In fact, Barbie et. al 2000 studied the correlation between the deactivation rate and cobalt crystallite size and observed a peak at 5.5 nm.

Embodiments Of the Invention

5 Embodiments of the invention described herein relate to a low-pressure Fischer-Tropsch process and a catalyst that produces a high diesel-fraction yield. Process pressure can be below 200 psig. The catalyst is cobalt deposited at greater than 5 weight percent on gamma alumina, optionally along with rhenium or ruthenium at 0.01 -2 wt. %, and have crystallites having an average diameter greater
10 than 16 nanometers. It has been discovered that this catalyst is very effective at low pressures in converting synthesis gas into diesel in high yield, producing a liquid hydrocarbon product containing less than 10 wt.% wax (>C23) and greater than 65% diesel (C9-C23). The present embodiments are particularly well suited to conversion of low pressure gases containing low molecular weight hydrocarbons into FT liquids.
15 Examples of applications are landfill gas, oil field solution gas and low pressure gas from de-pressured gas fields. In all these cases, multiple-stage gas and air compression would be required in traditional FT plants. The high efficiency of the present FT catalyst enables high CO conversion and produces a product stream containing up to 90+ wt. % diesel in a single pass. The use of air in the natural gas
20 reformer provides a synthesis gas containing approximately 50% nitrogen, which facilitates heat removal in the FT reactor as sensible heat and increases gas velocity and heat transfer efficiency, so that tail gas recycling is not needed. Naphtha can be partially separated from the hydrocarbon product by flash distillation at low cost to generate a more pure diesel product. This also serves to provide some product cooling.
25 The liquid hydrocarbon product is excellent for blending with petroleum diesel to increase cetane number and reduce sulfur content.

 The present embodiments can be applied to world-scale gas-to-liquid plants, but also to small FT plants using less than 100 million scfd. When applied to small
30 FT plants, the present embodiments strive for optimized economics with an emphasis on simplicity and minimized capital cost, possibly at the expense of efficiency. The

following is a comparison of existing FT technologies compared to the present embodiment as applied to small FT plants:

	Existing FT Technologies	Present Embodiments
5	Large plants, > 25MMscfd High pressure, > 200 psia Oxygen to reformer Extensive recycling to FT reactor or reformer	Small plants, < 100MMscfd Low pressure, < 200 psia Air to reformer No recycling ("once-through" process)
10	Low single-pass FT CO conversion (< 50%) Deliberate and extensive wax formation Hydrocracking waxes Multiple-pass FT reactors	High single-pass conversion (> 65%) Less than 10% wax formation No hydrocracking operations Single-pass-FT reactor
15	Low FT diesel yield (<50 %)	High diesel yield (55-90 % of hydrocarbon liquid)

In order to operate the FT process at high conversions with oxygen-blown reformer synthesis gas, the approach has been to recycle tail gas in a high proportion-
 20 at a ratio of 3.0 or greater based on fresh gas feed. A secondary benefit is that the fresh gas is diluted in carbon monoxide, which reduces the required rate of heat removal from the FT reactor, reduces hot-spotting and improves the product slate. However, tailgas recycling is a very energy and capital intensive activity. The separation of oxygen from air is also an energy and capital intensive activity.

25

The approach taken in the present process is to use air in the reformer, which gives a synthesis gas containing approximately 50 % nitrogen as inert diluent, eliminating the need for tail gas recycling to moderate FT reactor heat removal requirements. Others employing air-blown synthesis gas in FT processes have
 30 achieved the desired high CO conversions by using multiple FT reactors in series, which entails high capital costs and complex operation. The present process achieves

high CO conversion in a simple single pass and a high diesel cut by using a special catalyst as more particularly described below.

5 The catalyst in one embodiment employs an alumina support with high cobalt concentration, along with a low level of rhenium to facilitate catalyst reduction. The high cobalt concentrations increase catalyst activity, enabling high single-pass synthesis gas conversion. The catalyst is made to have a relatively large average cobalt crystallite size and this gives selectivity to a substantially diesel product.

10 The Anderson-Shultz-Florey theory predicts the FT hydrocarbons to cover a very wide range of carbon numbers, from 1-60, whereas the most desirable product is diesel fuel (C₉-C₂₃, Chevron definition). In order to reduce the 'losses' of CO to making C₁-C₅ hydrocarbons, a common approach is to strive to make mostly wax in the FT reactor and then, in a separate operation, to hydrocrack the wax to mostly
15 diesel and naphtha. Surprisingly, the process and catalyst of the present embodiments make diesel in high yield (to 90 wt%) directly in the FT reactor, obviating the need for expensive and complex hydrocracking facilities.

20 Because of the elimination of oxygen purification, high-pressure compression, tail gas recycling and hydrocracking, the present process can be applied economically in much smaller plants than hitherto considered possible for FT technology.

Figure 1 shows the process flow diagram for the FT process of the present embodiment, wherein the letters A-K signify the following:

25

- A** Raw hydrocarbon-containing gas
- B** Hydrocarbon gas conditioning equipment
- C** Reformer
- D** Water
- 30 **E** Oxidizing gas
- F** Cooler
- G** Separator

- H** hydrogen removal (optional)
- I** Fischer Tropsch reactor
- J** Back-pressure controller
- K** Product cooling and recovery (2-options)

5

Letter **A** represents the raw hydrocarbon-containing process feed gas. This could be from a wide variety of sources: for example, from a natural gas field, a land-fill facility (biogenic gas), a petroleum oil processing facility (solution gas), among others. The pressure of the gas for the present process can vary widely, from atmospheric pressure to 200 psia or higher. Single-stage or two-stage compression may be required, depending on the source pressure and the desired process operating pressure. For example, for landfill gas, the pressure is typically close to atmospheric pressure and blowers are used to transmit the gas into combustion equipment. Solution gas, which is normally flared, must also be compressed to the process operating pressure. There are also many old exploited and late-life natural gas fields with pressure too low for acceptance into pipelines that could make possible feedstock for the present process. Other natural gas sources, which may or may not be stranded (no access to a pipeline) may already be at or above the desired process operation pressure and these are also candidates. Another candidate is natural gas that is too high in inerts such as nitrogen to meet pipeline specifications.

20

Letter **B** represents hydrocarbon gas conditioning equipment. The gas may require clean-up to remove components that would damage reformer or FT catalyst. Examples of these are mercury, hydrogen sulfide, silicones and organic chlorides. Organic chlorides, such as found in land-fill gas, produce hydrochloric acid in the reformer, which can cause severe corrosion. Silicones form a continuous silicon dioxide coating on the catalyst, blocking pores. Hydrogen sulphide is a powerful FT catalyst poison and is usually removed to 1.0 ppm or lower. Some gas, from sweet-gas fields, may not require any conditioning (clean-up).

25
30

The hydrocarbon concentration in the raw gas affects the economics of the process because less hydrocarbon product is formed from the same volume of feed

gas. Nevertheless, the process can operate with 50% or lower methane concentration, for example, using land-fill gas. There may even be reasons to operate the process even at a financial loss; for example to meet greenhouse gas government or corporate emission standards. The process can operate with feed gases containing only methane
5 hydrocarbon or containing natural gas liquids by the application of known reformer technologies. The presence of carbon dioxide in the feed gas is beneficial.

Letter C represents the reformer, which may be of several types depending on the composition of the feed gas. A significant benefit of low pressure reformer
10 operation is the lower rate of the Brouard reaction and diminution of metal dusting.

Partial oxidation reformers normally operate at very high pressure i.e. 450 psia or greater, and so are not optimum for a low-pressure FT process. It is energetically inefficient, and can easily make soot, however, it does not require water, and makes a
15 syngas with a H_2/CO ratio near 2.0, optimum for FT catalysts. Partial oxidation reformers may be employed in the present process.

Steam reformers are capital expensive and require flue gas heat recovery to maximize efficiency in large plants. Because the synthesis gas contains relatively low
20 levels of inerts such as nitrogen, temperature control in the FT reactor can be difficult without tail gas recycling to the FT reactor. However, the low level of inerts enables recycling of some tail gas to the reformer tube-side, supplementing natural gas feed, or to the shell side to provide heat. Keeping in mind that FT tail gas must be
25 combusted before venting in any event, this energy can be used for electrical generation or, better yet, to provide the reformer heat which would be otherwise be provided from burning natural gas. For small FT plants, steam reformers are a viable choice. Steam reformers may be employed in the present process.

Autothermal reforming is an efficient process of relatively low capital cost
30 that uses moderate temperatures and modest steam concentrations to produce a soot-free synthesis gas with H_2/CO around 2.5 using low- CO_2 natural gas feed, which is closer to the desired ratio than for steam reforming. However some hydrogen removal

is still required for most natural gas feeds. If the feed gas contains greater than about 33 % CO₂, as is the case with land-fill gas feed, then an H₂/CO ratio of 2.0 can be achieved without any recycle streams, and the water use can also be diminished. This is the most desired type of reformer for the present low-pressure FT processes.

5

Letter D represents the optional water that is injected as steam into the reformer. All reformer technologies except partial oxidation require the injection of steam.

10 Letter E represents an oxidizing gas, which could be air, oxygen or oxygen-enriched air.

Letter F represents a cooler for reducing the reformer outlet temperature from greater than 700 °C. to close to ambient. The cooling may be done in several stages, but preferably in a single stage. The cooling may be achieved with shell- and- tube or
15 plate- and- frame heat exchangers and the recovered energy may be utilized to pre-heat the reformer feed gases, as is well known in the industry. Another way of cooling the reformer tail gas is by direct injection of water into the stream or by passing the stream through water in a vessel.

20

Letter G represents a separator for separating the reformer synthesis gas from condensed water, so as to minimize the amount of water entering downstream equipment.

25 Letter H represents optional hydrogen removal equipment such as Prism™ hydrogen-selective membranes which are sold by Air Products, or Cynara membranes from Natco.

Certain reformer processes produce a synthesis gas too rich in hydrogen, some
30 of which must be removed to achieve optimum FT reactor performance. An ideal H₂/CO ratio is 2.0-2.1, whereas the raw synthesis gas may have a ratio of 3.0 or

higher. High hydrogen concentrations give rise to larger CO loss to producing methane instead of the desired motor fuels or motor fuel precursor such as naphtha.

Letter I represents typical FT reactors, which are of the fixed-bed or slurry bubble type and either may be used. However, the fixed-bed is preferred in small plants because of its simplicity of operation and ease of scale-up.

Letter J represents a back-pressure controller which sets the process pressure. It may be placed in other locations depending on the product recovery and possible partial separation process employed.

Letter K represents product cooling and recovery. Product cooling is typically accomplished by heat exchange with cold water and serves to pre-heat the water for use elsewhere in the FT plant. Separation is accomplished in a separator vessel designed for oil/water separation. However a second alternative is to flash-cool the FT reactor product before the aforementioned cooler-separator as shown in Figure 2. This serves two purposes- firstly to reduce the product temperature and secondly to enable partial separation of the naphtha component in the produced hydrocarbon product, enriching the remaining liquid in the diesel component.

20

Figure 2 shows a process diagram, for flash separation of naphtha and diesel hydrocarbons, in which:

- 1 is a fixed-bed Fischer Tropsch reactor.
- 25 2 is a mixture of gases, water, naphtha, diesel and light waxes at ca.190-240 °C and pressure greater than atmospheric.
- 3 is a pressure let-down valve.
- 4 is stream 2 at reduced temperature due to gas expansion and at 14.7 psia.
- 30 5 is a flash drum vessel.
- 6 is a vapour phase consisting of stream 2 minus diesel and light waxes.

- 7 is a cooler.
 8 is stream 6 with naphtha and water in the liquid phase.
 9 is a vessel to retain naphtha and water.
 10 is a waste tailgas stream consisting mainly of inert gases and
 5 light hydrocarbons.

The FT products 2 flow through a pressure let-down valve 3 and into a flash drum 5. The inert gases and lower-boiling hydrocarbons, water and naphtha go overhead as vapour out of the flash drum and through cooler 7. The diesel and light
 10 waxes collect in vessel 5. The water and naphtha condense in cooler 7 and are collected in vessel 9. The remaining gases exit overhead in stream 10 and are typically combusted, sometimes with energy recovery, or are used to generate electricity.

15 EXAMPLES

Catalyst Supports Employed

20 **Table 1. Physical characteristics of catalyst supports**

Alumina catalyst support (supplier's data)	Alcoa LD-5	Alcoa CSS-350	Alcoa F-220	Sasol Trilobes	Degussa Aerolyst 3038
Surface Area, m ² /g	300 min	350	360	248	270
Average Particle size, microns	various	2120	2000	1670x4100	2500
Pore Volume, cc/g	0.63	0.57	0.5	0.82	0.9-1.0
Bulk Density, g/cc	0.645	0.72	0.769	0.42	0.40-0.46
Al ₂ O ₃ , %wt	Diff.	99.6	93.1	Diff.	<500 ppm
SiO ₂ , %wt	0.40 max	0.02	0.02	0.015	>99.8
Fe ₂ O ₃ , %wt, max	0.04	-	0.02	0.015	<30 ppm
Na ₂ O, %wt, max	0.2	0.35	0.3	0.05	-
LOI (250-1100°C), %wt	23-30	3.5	6.5	-	-

Example 1

Catalyst synthesis was conducted by ordinary means as practiced by those
 25 knowledgeable in the art. The catalyst support was alumina trilobe extrudate obtained

from Sasol Germany GmbH (hereafter referred to as 'trilobe'). The extrudate dimensions were 1.67 mm diameter and 4.1 mm length. The support was calcined in air at 500 °C. for 24 hours. A solution mixture of cobalt nitrate and perrhenic acid was added to the support by the method of incipient wetness to achieve 5 wt% cobalt metal and 0.5 wt.% rhenium metal in the finished catalyst (Catalyst 1). The catalyst was oxidized in three steps:

Step 1: the catalyst was heated to 85 °C and held for 6 hours.

Step 2: the temperature was raised to 100 °C at 0.5 °C per minute and held for 4-hours;

Step 3: the temperature was raised to 350 °C at 0.3 °C per minute and held for 12 hours.

The drying rate of the wet catalyst was somewhat dependent upon the size of catalyst particles. Smaller particles will dry more quickly than larger particles and the size of the crystals formed inside the pores can vary with crystallization rate. A volume of 29 cc of oxidized catalyst was placed in a ½ inch OD tube that had an outer annular space through which temperature-control water was flowed under pressure in order to remove the heat of reaction. In effect, the FT reactor was a shell-and-tube heat exchanger with catalyst placed in the tube side. The inlet gas and water were both at the targeted reaction temperature. Catalyst reduction was accomplished by the following procedure:

Reduction- gas flow rate (cc/min)/H₂ in nitrogen (%) /temperature (°C.) /time (hours):

1. 386/70/200/4, pre-heat stage
2. 386/80/to 325/4, slow heating stage
3. 386/80/325/30, fixed- temperature stage

During Fischer-Tropsch catalysis, total gas flow to the FT reactor was at a GHSV of 1000 hr⁻¹. Gas composition was representative of an air-autothermal reformer gas: 50% nitrogen, 33.3% H₂ and 16.7 % CO. A seasoning of the catalyst was used to

reduce methane production. This was accomplished by holding the reactor temperature at 170 °C. for the first 24 hours. Presumably, this process causes carbonylation of the cobalt surface and increased FT activity. CO conversion and liquid production were measured at a variety of temperatures between 190 °C. and
5 220 °C.

Example 2

The catalyst used in this example (Catalyst 2) was the same as the catalyst used in Example 1, except that the cobalt metal loading was 10 wt%.

10

Example 3

The catalyst used in this example (Catalyst 3) was the same as the catalyst used in Example 1, except that the cobalt metal loading was 15 wt%.

Example 4

The catalyst used in this example (Catalyst 4) was the same as the catalyst used in Example 1, except that the cobalt metal loading was 20 wt%.

Example 5

The catalyst used in this example (Catalyst 5) was the same the catalyst used in Example 1, except that the cobalt metal loading was 26 wt%.

20

Example 6

The catalyst used in this example (Catalyst 6) was the same the catalyst used in Example 1, except that the cobalt metal loading was 35 wt%.

25

Example 7

The catalyst used in this example (Catalyst 7) was the same as the catalyst used in Example 1, except that the alumina support was CSS-350, obtained from Alcoa, and the cobalt loading was 20 weight percent. This support is spherical with a diameter of 1/16 inch.

30

Examples 8a, 8b, 8c & 8d

The catalysts used in these examples (Catalysts 8a, 8b, 8c, and 8d) were the same as used in Example 1, except as follows: Catalyst 8a was identical to Catalyst 1, except that the alumina support was LD-5, obtained from Alcoa, and the cobalt loading was 20 weight percent. This support is spherical with an average particle distribution of 1963 microns. Example 8a used the particle size mixture as received. Some of the original particles were ground to smaller sieve sizes: Catalysts 8b, 8c and 8d were made with particles of diameter 214, 359 and 718 microns respectively. The cobalt loading in Examples 8b, 8c and 8d was identical to Catalyst 8a.

Example 9.

The catalyst used in this example (Catalyst 9) was the same as the catalyst used in Example 1, except that the alumina support was F-220, obtained from Alcoa, and the cobalt loading was 20 weight percent. F-220 is a spherical support with a mesh size distribution of 7/14.

Example 10

The catalyst used in this example (Catalyst 10) was the same as Catalyst 4, except that the promoter was ruthenium rather than rhenium.

Example 11

The catalyst used in this example (Catalyst 11) was the same as Catalyst 3, except that Aerolyst 3038 silica catalyst support from Degussa was used instead of alumina.

Example 12

The catalyst used in this example (Catalyst 12) was identical with Catalyst 8d having the same catalyst support, particle size and catalyst loading, except that the oxidizing process hold times were doubled during catalyst synthesis. That is, the temperature hold times were respectively to 12, 8 and 24 hours for the 3-oxidizing steps described for Catalyst 1. The intention of slower catalyst oxidation rates of the small Catalyst 12 particles was to achieve a larger cobalt crystallite size (21.07 nm)

within the pores of the small support particle in comparison with the crystallite size under faster crystallization conditions of Catalyst 8d (15.72). The method used herein to control drying rate and catalyst cobalt crystallite size is not meant to exclude any other method to achieve larger crystallite sizes. For example, the relative humidity or
 5 pressure of the drying chamber could be varied to control the catalyst drying rate and therefore cobalt crystallite size.

Catalyst Characterization

The above Catalysts were analyzed for average crystallite size ($d(\text{CoO})$),
 10 Dispersion (D%) and Degree of Reduction (DOR) using a Chembet 3000 (Quantachrome Instruments) TPR/TPD analyzer. The catalyst was reduced at 325°C in H_2 flow and cobalt dispersion was calculated assuming that one hydrogen molecule covers two cobalt surface atoms. Oxygen chemisorption was measured with a series of (O_2/He) pulses passed through the catalyst at 380°C temperature after reducing the
 15 catalyst at 325°C. The up-take oxygen moles were determined and degree of reduction was calculated assuming that all cobalt metal was re-oxidized to Co_3O_4 . Cobalt crystallite size was calculated from:

$$d(\text{CoO}) = (96/D\%) \text{ DOR}$$

D% : Dispersion

20

FT Catalyst Evaluation

(i) Influence of cobalt loading

25

The effect of Co loading on catalyst performance was tested with Examples 1-6 with the results shown in Table 2.

Table 2. Effect of catalyst loading on performance on Examples 1-6 (trilobes) at 70 psia.

30

Weight % Cobalt (Example number)	5 (1)	10 (2)	15 (3)	20 (4)	26 (5)	35 (6)
Optimum Temperature, °C	220	210	205	200	200	200
Hydrocarbon Liquid Rate, ml/h	0.09	0.54	0.74	1.03	0.77	0.86
Naphtha, wt%	6.4	8.8	13.9	17.9	16.4	15.8
Diesel, wt%	92.5	82.8	78.3	75.3	76.8	76.8
Light wax, wt%	1.1	6.4	7.8	6.9	6.8	7.4

Diesel production, ml/h	0.08	0.45	0.58	0.78	0.59	0.66
CO Conversion, mol %	19.4	42.0	61.2	85.1	82.8	83.1
C5+ Selectivity, %	28.6	80.6	71.3	68.0	65.1	64.3
Cetane number	81	79	77	78	74	75

Tests for each of Examples 1-6 were conducted at various temperatures, and the temperature that gave the largest amount of hydrocarbon product is listed. It is clear that 5% cobalt was not enough to provide a useful amount of liquid hydrocarbons: the best concentration was 20 wt% Co, which gave 1.03 ml/h. The concentration of diesel range hydrocarbons in the hydrocarbon product was 75.3-92.5 % at cobalt loadings of 10 wt% cobalt or higher. The highest diesel production rate (0.78 ml/h) was achieved with the trilobe support with 20% cobalt at 70 psia.

The performance data for Catalyst 1 at 202.5 is shown in Table 8. The level of wax (C>23) on the C5+ liquid was only 6.8 % and the diesel fraction was 73.5% (C9-C23). It was found that for all Catalysts tested where the crystallite average diameter was greater than 16 nm, the C5+ wax was less than 10 weight %, enabling the product to be used directly as diesel blend.

Figure 3 shows the carbon number distribution for Catalyst 3 (trilobe) in Example 3 at 190 °C. A very narrow distribution was obtained having no heavy wax. Diesel was 90.8%, naphtha 6.1% and light waxes 3.1%. Cetane number was very high at 88. In all graphs of carbon numbers, naphtha is indicated by large squares, diesel by diamonds and light waxes by small squares.

Influence of pressure

Catalyst 4 in Example 4 was run in the standard testing rig as described above at a temperature of 202.5 °C. at a variety of pressures. Results in Table 3 and Figure 4 indicate that productivity of the catalyst for production of liquid hydrocarbons was significant at low pressures down to 70 psia, with the optimum results obtained at pressures between 70 psia and 175 psia. Preferred pressures are 70-450 psia and most preferably from 70 to 175 psia. The diesel fraction over that pressure range was fairly constant at 70.8-73.5 weight percent. As shown in Table 8, Catalyst 4, with 20 %

cobalt had an average crystallite size of 22.26 nm and a C5+ wax fraction of 6.8 wt % enabling the product to be used as a diesel blend.

5 **Table 3. Effect of pressure on catalyst performance (Catalyst 4, 202.5 °C.).**

Pressure, psia	40	70	100	125	140	175	200
Hydrocarbon Liquid Rate, ml/h	0.405	1.047	1.082	1.034	1.046	1.079	0.805
Naphtha, wt%	8.5	19.7	24.7	23.5	23.9	26.6	23.9
Diesel, wt%	77.8	73.5	71.9	73.1	73.4	70.8	74.1
Light wax, wt%	13.7	6.8	3.4	3.4	2.7	2.6	2.0
Diesel production, ml/h	0.32	0.77	0.78	0.76	0.77	0.76	0.60
CO Conversion, mol %	59.4	90.2	84.1	83.8	74.8	73.4	65.8
C5+ Selectivity, %	76.6	58.1	54.4	52.5	61.3	57.7	52.0

Catalyst 7

As seen in Table 4, the maximum diesel production rate was achieved at 215 °C. and 70 psia. Compared with Catalyst 4, Catalyst 7 gave a lower diesel production rate at its optimum temperature (215 °C.), but a higher diesel fraction. Figure 5 shows the narrow carbon number range in the liquid product at 190 °C., with 89.6% in the diesel range. Cetane number was 81. However, as shown in Table 8, the crystallite size was 18.26 nm, and the wax fraction was 7.2% enabling the product to be used as a diesel blend.

15 **Table 4. Performance of Catalyst 7 at various temperatures (CSS-350).**

Temperature, °C	190	200	210	215	220
Hydrocarbon Liquid Rate, ml/h	0.55	0.58	0.64	0.70	0.68
Naphtha, wt%	5.4	15.2	13.4	15.4	14.3
Diesel, wt%	89.6	76.8	82.0	77.4	81.3
Light wax, wt%	5.0	8.0	4.6	7.2	4.4
Diesel production, ml/h	20.1	47.2	45.2	53.8	49.5
Average Molecular Weight	194.9	170.2	171.2	164.8	168.3
CO Conversion, mol %	47.8	53.4	81.6	93.8	100.0

20 Catalysts 8a, 8b, 8c, and 8d

The testing results are shown in Table 5. Catalysts 8b, 8c and 8d showed Co metal dispersion higher than for Catalyst 8a. Catalysts that contain Co⁰ average crystallite sizes below 16 nanometers gave a high wax cut in the FT product of 17.6-

19.3% wt, whereas Catalyst 8a and Catalyst 12, which contained Co⁰ crystallites larger than 16 nm gave lower wax cuts of 6.6 and 7.8 wt.% respectively in the C5+ liquid, enabling the product to be used as a diesel blend. Of note, Catalysts 8a and 12 had very different particle sizes, but gave similar low wax cuts. This shows that the controlling variable for low wax concentrations was crystallite size, and not particle size.

Table 5. Performance of Catalyst 8a-8d and 12 at 70 psia.

Catalyst	8a	12	8b*	8c*	8d*
Average Particle size, microns	1963	718	274	359	718
Average crystallite size, nm	23.06	21.07	9.19	14.76	15.72
Dispersion, %	4.16	4.56	10.45	6.5	6.11
Fischer-Tropsch test Temperature, °C	200	205	200	200	200
C5+ composition wt. %:					
Naphtha (carbon number C6-C8)	9.3	15.7	10.1	10.4	11.4
Diesel (carbon number C9-C23)	84.1	76.5	70.9	72	69.3
Wax (carbon number > C23)	6.6	7.8	19.0	17.6	19.3
Average molecular weight, AMU	182	160	195	190	193
CO conversion, %	52.7	51.2	88.8	72.7	69.3

*Not part of the present Application

10

Catalyst 9

Catalyst 9 was tested at 70 psia. As shown in Table 6 and Figure 7, the 190 °C hydrocarbon product contained 99.1% "naphtha plus diesel". Diesel itself was at 93.6%. There was very little light wax. Cetane number was 81. As shown in Table 8, the crystallite size was 22.22 nm and the wax fraction was 2.3 %, enabling the product to be directly as a diesel fuel.

Table 6. Performance of Catalyst 9 (F-220) at various temperatures (pressure 70 psia).

Temperature, °C	190	200	210	215
Hydrocarbon Liquid Rate, ml/h	0.465	0.757	0.8	0.733
Naphtha, wt%	5.5	9.2	20.1	21.5
Diesel, wt%	93.6	88.5	77.0	74.7
Light wax, wt%	0.9	2.3	2.9	3.8
Diesel production, ml/h	0.41	0.62	0.53	0.47
Average Molecular Weight	188.2	181.4	157.7	154.1
CO Conversion, mol %	50.0	72.2	94.7	92.2
Cetane number	81.0	76.0	67.0	65.0

20

Catalyst 10:

5 Data in Table 7 and Figure 8 show that the use of ruthenium catalyst promoter instead of rhenium also provides a narrow distribution of hydrocarbons with 74.42% in the diesel range having an overall cetane number of 78. As shown in Table 8, the crystallite size was 20.89 nm and the wax fraction was 3.73 %, enabling the product to be used as a diesel blend.

10

Table 7. Performance of Catalyst 10 (Ruthenium promoter, LD-5 alumina support).

Temperature, °C/Pressure, psia	215
Conversion, %	94.64
C5+ liquid rate, ml/h	0.73
Diesel production rate, ml/h	0.54
C5+ weight fractions, %:	
Naphtha (C6-C8)	21.85
Diesel (C9-C23)	74.42
Wax (>C23)	3.73
Cetane number	78
Average molecular weight	164

15

Catalyst 11

20 For Catalyst 11, the hydrocarbon liquid production rate was 0.55 ml/h at 210 °C. The carbon distribution curve shown in Figure 9 demonstrates a narrow distribution with a high diesel cut. As shown in Table 8, the crystallite size was 33.1 nm and the wax fraction was 5.2 %, enabling the product to be used as a diesel blend, perhaps after flashing off the naphtha fraction.

25

Table 8. Summary of the effect of cobalt crystallite size on C5+ wax concentration.

Catalyst Number	4	7	9	10	11	12
Name	Trilobes	CSS-	F-220	LD-5/Ru	Aerolyst 3038	LD-5
Average crystallite size, nm	22.26	18.26	22.22	20.89	33.10	21.07
Dispersion, %	4.81	5.26	4.32	4.60	2.90	4.58
F-T test temperature, °C	202.5	215	200	215	200	205

C5+ composition wt. %:						
Naphtha (carbon number C6-C8)	19.7	15.4	9.2	21.9	20.7	15.7
Diesel (carbon number C9-C23)	73.5	77.4	88.5	74.4	74.1	78.5
Wax (carbon number > C23)	6.8	7.2	2.3	3.7	5.2	7.8
Average molecular weight, AMU	165	165	181	164	147	160
CO conversion, %	90.2	93.8	72.2	92.6	57	51.2

Catalysts 1 to 12 (except catalysts 8 b, c and d) in this disclosure show that a narrow distribution of hydrocarbons, mainly in the diesel range, having low wax content (<10 wt.%) is obtained when the FT catalyst has cobalt crystallites larger than 16 nm, as shown in Figure 10 (the large squares are not part of this embodiment). With small catalyst particles (e.g. Catalyst 12) it is necessary to control the crystallization rate in order to obtain the desired crystallite size.

Figure 11 compares this result with expectations from the Anderson-Shultz-Flory (A-S-F) carbon number distribution based on chain growth. The A-S-F distribution provides only 50 wt. % diesel fraction, whereas the present embodiments provide > 65 wt. %.

The liquid hydrocarbon product of the present catalysts is more valuable than the broad A-S-F type of product because it can be used directly as a diesel-blending stock without hydrocracking to increase cetane number and decrease sulphur content of petroleum diesels. Because the present process can be a simple once-through process, it can entail low capital cost.

Although the disclosure describes and illustrates preferred embodiments of the invention, it is to be understood that the invention is not limited to these particular embodiments. Many variations and modifications will now occur to those skilled in the art. For a complete definition of the invention and its intended scope, reference is to be made to the summary of the invention and the appended claims read together with and considered with the disclosure and drawings herein.

What is claimed is:

1. A Fischer-Tropsch process having a cobalt catalyst with crystallites, the crystallites having an average diameter greater than 16 nanometers, the process producing a liquid hydrocarbon product containing less than 10 weight percent wax ($>C_{23}$) and greater than 65% diesel (C_9-C_{23}).
2. The process of claim 1 having a Fischer-Tropsch catalyst support for the cobalt catalyst, wherein said catalyst support is selected from the group of catalyst supports consisting of alumina, zirconia, titania and silica.
3. The process of any one of claims 1 or 2 wherein the cobalt catalyst has a catalyst loading, and wherein said catalyst loading is greater than 10 weight %.
4. The process of any one of claims 1 to 3 wherein the operating pressure for said Fischer-Tropsch process is less than 200 psia.
5. The process of any one of claims 1 to 4 wherein promoters are utilized in such process, and said promoters are selected from the group of promoters consisting of : ruthenium, rhenium, rhodium, nickel, zirconium, titanium, and mixtures thereof.
6. The process of any one of claims 1 to 5 wherein a flash distillation is conducted on the process to reduce the naphtha cut.
7. The process of any one of claims 1-6 wherein the process uses a FT reactor that does not use tailgas recycle.

8. The processes of any one of claims 1-7 wherein the process uses a reformer that uses air as an oxygen source
9. The processes of any one of claims 1-8 wherein the reactor is a fixed-bed FT reactor or a slurry bubble bed FT reactor.
10. A Fischer-Tropsch process operating at less than 200 psia, using an air autothermal reformer, and having a CO conversion of at least 65 % and providing a diesel yield greater than 60% by weight in a single- pass Fischer-Tropsch reactor using a cobalt catalyst, said catalyst having a metallic cobalt loading greater than 5% by weight and rhenium loading of less than 2% by weight on a catalyst support material selected from the group of catalyst support materials comprising alumina, zirconia, and silica, wherein said cobalt catalyst is in the form of crystallites, said crystallites having an average diameter greater than 16 nanometers.
11. The process of claim 10 wherein the Fischer-Tropsch catalyst support material is comprised of alumina.
12. The process of claim 10 having a feed gas, wherein selective membranes or molecular sieves are employed to remove hydrogen from the feed gas.
13. The process of claim 10 wherein the cobalt catalyst loading is greater than 6 weight %.
14. The process of claim 10 wherein the operating pressure is less than 100 psia.

15. A Fischer-Tropsch process as claimed in claim 10, said reactor further having a promoter, wherein said promoter comprises a promoter selected from the group of promoters consisting of ruthenium and rhenium or mixtures thereof.
16. A Fischer-Tropsch process operating at less than 200 psia, using an oxygen autothermal reformer, and having a CO conversion of at least 65 % and providing a diesel yield greater than 60% by weight in a Fischer-Tropsch reactor using a cobalt catalyst, said catalyst having a metallic cobalt loading greater than 5% by weight and a rhenium loading of less than 2% by weight on a catalyst support selected from the group of catalyst supports comprised of alumina, zirconia and silica materials, wherein said cobalt catalyst is in the form of crystallites, said crystallites having an average diameter greater than 16 nanometers.
17. The process of claim 16 wherein the Fischer-Tropsch catalyst support is comprised of alumina.
18. The process of claim 16 having a tailgas from the reformer, wherein the tailgas is partially recycled to the reformer.
19. The process of claim 16 further having a feed gas wherein selective membranes or molecular sieves are employed to remove hydrogen from the gas.
20. The process of claim 16 wherein the cobalt catalyst loading is greater than 6 weight %.
21. The process of claim 16 wherein the operating pressure is less than 100 psia.

22. A Fischer-Tropsch process of claim 16, said reactor further having a promoter, wherein said promoter comprises a promoter selected from the group of promoters consisting of ruthenium or rhenium, or mixtures thereof
23. A Fischer-Tropsch process operating at less than 200 psia, using an oxygen steam reformer, and having a CO conversion of at least 65 % and providing a diesel yield greater than 60% in by weight in a Fischer-Tropsch reactor using a cobalt catalyst with a metallic cobalt loading greater than 5% by weight and rhenium loading of less than 2% by weight on a catalyst support selected from the group of catalyst supports comprised of alumina, zirconia, or silica materials, or mixtures thereof, wherein said cobalt catalyst is in the form of crystallites, said crystallites having an average diameter greater than 16 nanometers.
24. The process of claim 23 wherein the Fischer-Tropsch catalyst support is comprised of alumina.
25. The process of claim 23 further having a feed gas, wherein selective membranes or molecular sieves are employed to remove hydrogen from the feed gas.
26. The process of claim 23 having a tailgas from the reformer, wherein some or all of the tailgas is burned to provide heat to the reformer.
27. The process of claim 23 wherein the cobalt catalyst loading is greater than 6 weight %.
28. The process of claim 23 wherein the operating pressure is less than 100 psia.

29. A Fischer-Tropsch process of claim 23, said reactor further having a promoter, wherein said promoter comprises a promoter selected from the group of promoters comprising ruthenium, rhenium, or mixtures thereof
30. A Fischer-Tropsch process operating at less than 200 psia, using an air or oxygen partial oxidation reformer, and having a CO conversion of greater than 65 % and providing a diesel yield greater than 60% by weight in a Fischer-Tropsch reactor using a cobalt catalyst with a metallic cobalt loading greater than 5% by weight and rhenium loading of less than 2% by weight on a Fischer-Tropsch catalyst support selected from the group of catalyst supports comprising alumina, zirconia, and silica materials, wherein said cobalt catalyst is in the form of crystallites, said crystallites having an average diameter greater than 16 nanometers.
31. The process of claim 30 wherein the Fischer-Tropsch catalyst support is comprised of alumina.
32. The process of claim 30 having a feed gas, wherein selective membranes or molecular sieves are employed to remove hydrogen from the feed gas.
33. The process of claim 30 wherein the cobalt catalyst loading is greater than 6 weight %.
34. The process of claim 30 wherein the operating pressure is less than 100 psia.
35. A Fischer-Tropsch process of claim 30, said reactor further having a promoter, wherein said promoter comprises a promoter selected from the group of promoters comprising ruthenium, rhenium, or mixtures thereof.

AMENDED CLAIMS**received by the International Bureau on 01 June 2010 (01.06.2010)**

1. A Fischer-Tropsch process for producing a liquid hydrocarbon substantially comprising diesel fuel or diesel blending stock, the process producing a liquid hydrocarbon product containing less than 10 weight percent wax ($>C_{23}$) and greater than 65% diesel (C_9-C_{23}), such Fischer-Tropsch process comprising:
 - operating at pressures below 200 psia; and
 - utilizing a cobalt catalyst comprising a Fischer-Tropsch catalyst support having cobalt metal crystallites thereon, said cobalt metal crystallites having an average diameter greater than 16 nanometers.
2. The process of claim 1, wherein said Fischer-Tropsch catalyst support is a catalyst support selected from the group of catalyst supports consisting of alumina, gamma alumina, zirconia, titania, silica, and mixtures thereof.
3. The process of any one of claims 1 or 2 wherein the cobalt catalyst has a metallic cobalt catalyst loading, and wherein said metallic cobalt catalyst loading is at least 15 weight %.
4. The process of any one of claims 1 to 3 wherein conversion of CO in feed gas is at least 60%.
5. The process of any one of claims 1 to 4 wherein promoters are utilized in such process, and said promoters are selected from the group of promoters consisting of : ruthenium, rhenium, rhodium, nickel, zirconium, titanium, and mixtures thereof.
6. The process of any one of claims 1 to 5 wherein a flash distillation is conducted to reduce light hydrocarbon cuts which have lower boiling points than diesel.

7. The process of any one of claims 1-6 wherein the process uses a Fischer-Tropsch reactor that does not use tailgas recycle.
8. The process of any one of claims 1-7 wherein the process uses a reformer that uses air as an oxygen source.
9. The process of any one of claims 1-8 wherein a Fischer-Tropsch reactor used in said Fischer-Tropsch process is a fixed-bed Fischer-Tropsch reactor or a slurry bubble bed Fischer-Tropsch reactor.
10. A Fischer-Tropsch process operating at less than 200 psia, using an air autothermal reformer, and having a CO conversion of at least 60 % and providing a diesel yield greater than 65% by weight in a single-pass Fischer-Tropsch reactor, comprising the step of :
using a cobalt catalyst, said catalyst having a metallic cobalt loading of at least 15% by weight and rhenium loading of less than 2% by weight, said cobalt catalyst having a catalyst support material selected from the group of catalyst support materials consisting of alumina, zirconia, silica, and mixtures thereof and having cobalt metal crystallites thereon, said cobalt metal crystallites having an average diameter greater than 16 nanometers.
11. The process of claim 10 wherein the Fischer-Tropsch catalyst support material is comprised of gamma-alumina.
12. The process of claim 10 having a Fischer-Tropsch feed gas, wherein selective membranes or molecular sieves are employed to remove hydrogen from the Fischer-Tropsch feed gas.
13. The process of claim 10 wherein the operating pressure is at least 40 psia, and temperature in the Fischer-Tropsch reactor is at least 190°C.

14. The process of claim 10 wherein the operating pressure is less than 100 psia.
15. A Fischer-Tropsch process as claimed in claim 10, said cobalt catalyst further having a promoter, wherein said promoter comprises a promoter selected from the group of promoters consisting of ruthenium, rhenium, and mixtures thereof.
16. A Fischer-Tropsch process having a CO conversion of at least 60 % and providing a diesel yield greater than 65% by weight in a Fischer-Tropsch reactor , comprising:
 - operating at pressures less than 200 psia;
 - using an oxygen autothermal reformer; and
 - using a cobalt catalyst, said catalyst having a metallic cobalt loading of at least 15% by weight and a rhenium loading of less than 2% by weight, on a Fischer-Tropsch catalyst support material selected from the group of catalyst support materials consisting of alumina, zirconia, silica, and mixtures thereof, wherein said cobalt catalyst is in the form of cobalt metal crystallites, said crystallites having an average diameter greater than 16 nanometers.
17. The process of claim 16 wherein the Fischer-Tropsch catalyst support is comprised of alumina.
18. The process of claim 16 having a tailgas from the Fischer-Tropsch reformer, wherein the tailgas is partially recycled to the reformer.
19. The process of claim 16 further having a Fischer-Tropsch reactor feed gas wherein selective membranes or molecular sieves are employed to remove hydrogen from the feed gas.

20. The process of claim 10 wherein the operating pressure is at least 40 psia, and temperature in the Fischer-Tropsch reactor is at least 190°C.
21. The process of claim 16 wherein the operating pressure is no greater than 100 psia.
22. A Fischer-Tropsch process of claim 16, said reactor further having a promoter, wherein said promoter comprises a promoter selected from the group of promoters consisting of ruthenium, rhenium, and mixtures thereof
23. A Fischer-Tropsch process for a Fischer-Tropsch reactor, comprising:
 - operating at pressures less than 200 psia;
 - using an oxygen steam reformer;
 - having a CO conversion of at least 60 % and providing a diesel yield greater than 65% by weight; and
 - using a cobalt metal catalyst with a metallic cobalt loading of at least 15% by weight and rhenium loading of less than 2% by weight on a Fischer-Tropsch catalyst support material selected from the group of catalyst support materials consisting of alumina, zirconia, silica, and mixtures thereof, wherein said catalyst support material possesses cobalt metal crystallites, said crystallites having an average diameter greater than 16 nanometers, .
24. The process of claim 23 wherein the Fischer-Tropsch catalyst support is comprised of gamma alumina.
25. The process of any one of claims 23 to 24 further having a Fischer-Tropsch reactor feed gas, wherein selective membranes or molecular sieves are employed to remove hydrogen from the feed gas.

26. The process of any one of claim 23 to 25 having a tailgas from the reformer, wherein some or all of the tailgas is burned to provide heat to the reformer.
27. The process of any one of claims 23 to 26 wherein the operating pressure is at least 40 psia and the temperature is at least 190°C.
28. The process of any one of claims 23 to 27 wherein the operating pressures are less than 100 psia.
29. A Fischer-Tropsch process of any one of claims 23 to 28, said reactor further having a promoter, wherein said promoter comprises a promoter selected from the group of promoters consisting of ruthenium, rhenium, and mixtures thereof
30. A Fischer-Tropsch process having a CO conversion of greater than 60 % and providing a diesel yield greater than 65% by weight, comprising:
 - operating at less than 200 psia,
 - using an air or oxygen partial oxidation reformer, and
 - using a Fischer-Tropsch reactor having a cobalt catalyst with a metallic cobalt loading greater than 15% by weight and rhenium loading of less than 2% by weight on a Fischer-Tropsch catalyst support material, said Fischer-Tropsch catalyst support material selected from the group of catalyst support materials consisting of alumina, zirconia, and silica, and mixtures thereof, wherein said cobalt catalyst is in the form of metallic metal crystallites, said crystallites having an average diameter greater than 16 nanometers.
31. The process of claim 30 wherein the Fischer-Tropsch catalyst support is comprised of alumina.

32. The process of claim 30 or 31 having a Fischer-Tropsch reactor feed gas, wherein selective membranes or molecular sieves are employed to remove hydrogen from the feed gas.
33. The process of claim 30 wherein the operating pressure is at least 40 psia, and the temperature is at least 190°C.
34. The process of claim 30 wherein the operating pressure is less than 100 psia.
35. A Fischer-Tropsch process of claim 30, said reactor further having a promoter, wherein said promoter consists of a promoter selected from the group of promoters consisting of ruthenium, rhenium, and mixtures thereof.

STATEMENT UNDER ARTICLE 19(1) (Rule 46.4)

Independent claims 1, 10, 16, 23, and 30 have each *inter alia* been amended to expressly recite that it is the cobalt metal crystallite which has an average diameter greater than 16 nanometers in order to distinguish over such prior art references as US 7,452,844 which teaches a cobalt oxide crystallite with a diameter of 40-200 angstroms (ie 4-20 nanometers) [ie teaches a particle size (as opposed to a metal size) of 4-20 nanometers]. The amended independent claims now specifically recite such limitation to similarly distinguish over applicant's prior publication CA 2,567,425 (now abandoned) which fails to *inter alia* disclose the limitation that the cobalt metal crystallite diameter be greater than 16 nanometers and thus fails to enable the invention to consistently produce the desired recited limitations of greater than 65% diesel cut and less than 10% wax, particularly at low operating pressures of less than 200 psia.

Further amendments of a formalistic nature, including amendment to recite a conversion of at least 60% CO, as opposed to formerly reciting at least 65% CO conversion which was not supported by all examples tested, have been included in the claims as now amended.

STATEMENT UNDER ARTICLE 19 (1)

FIGURE 1

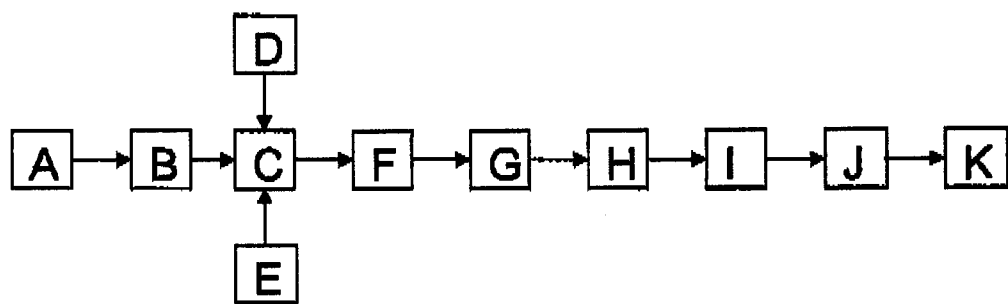

FIGURE 2

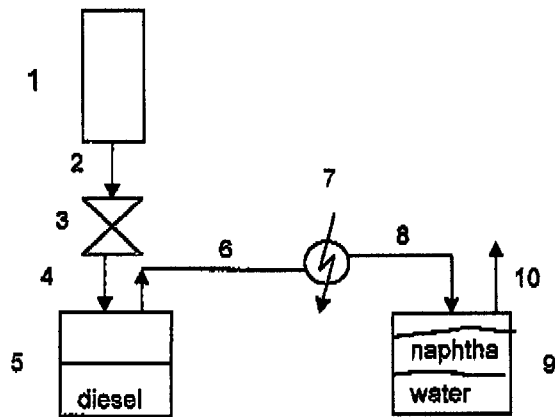
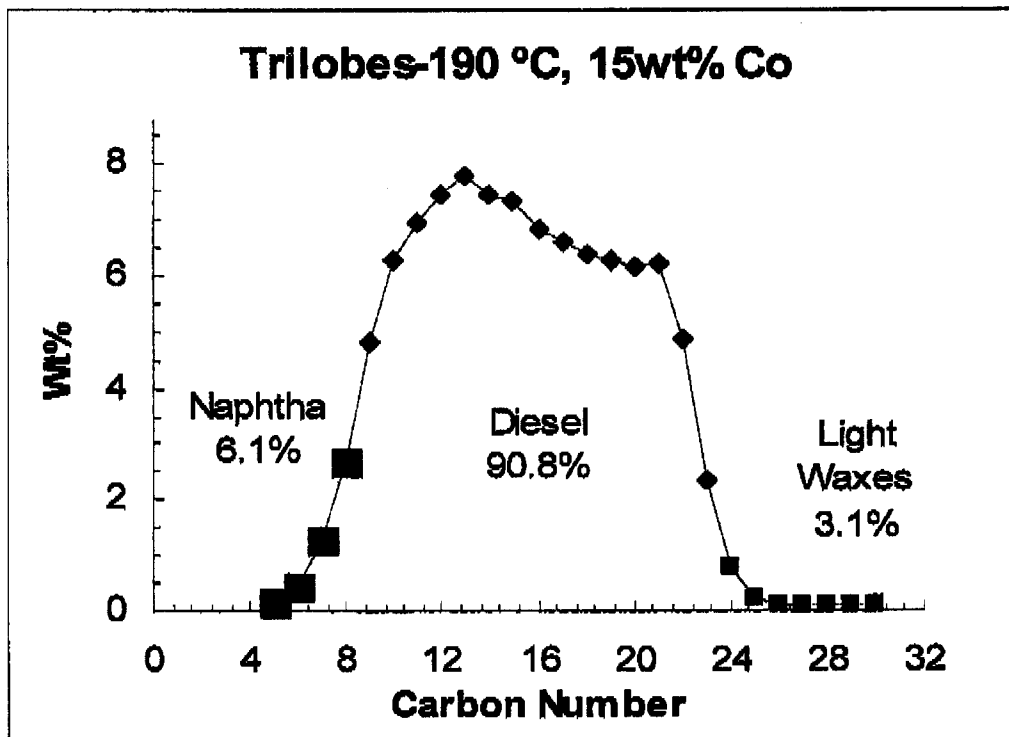

FIGURE 3



4/11

FIGURE 4

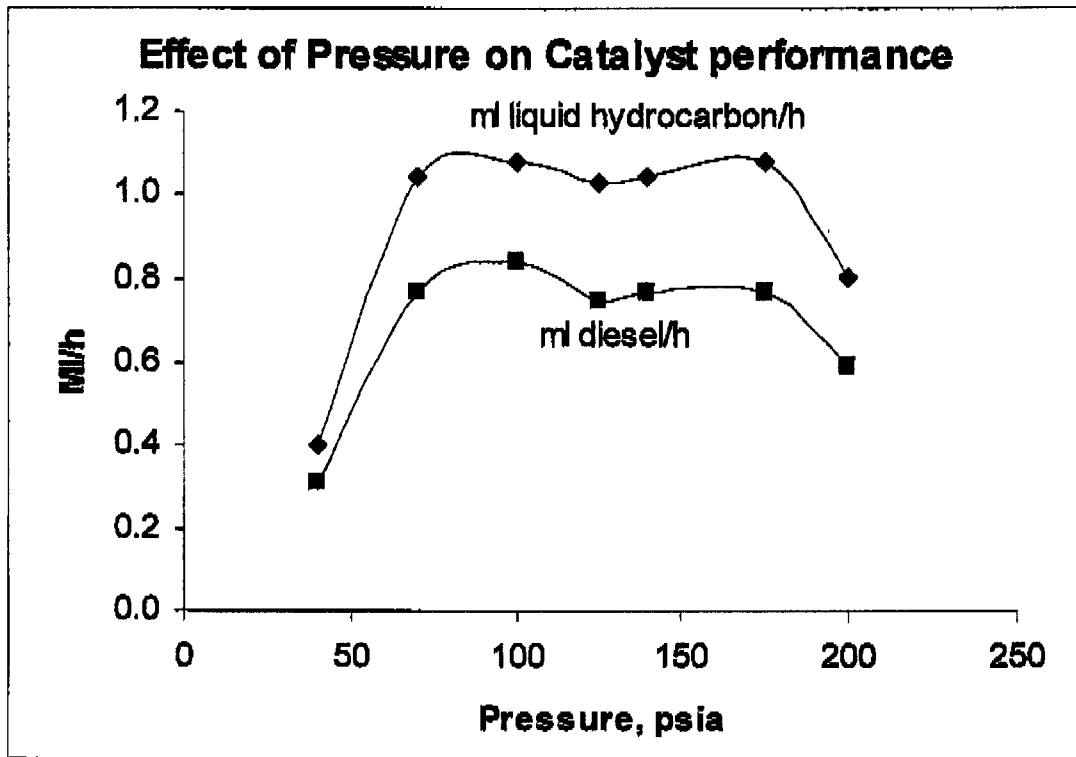
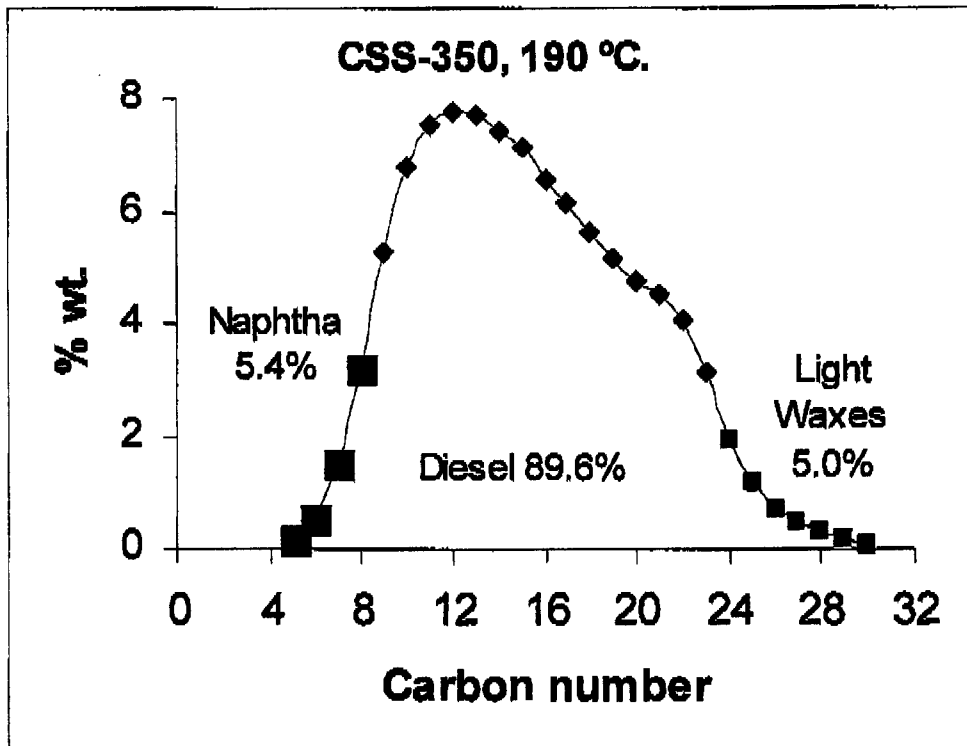

FIGURE 5



6/11

FIGURE 6

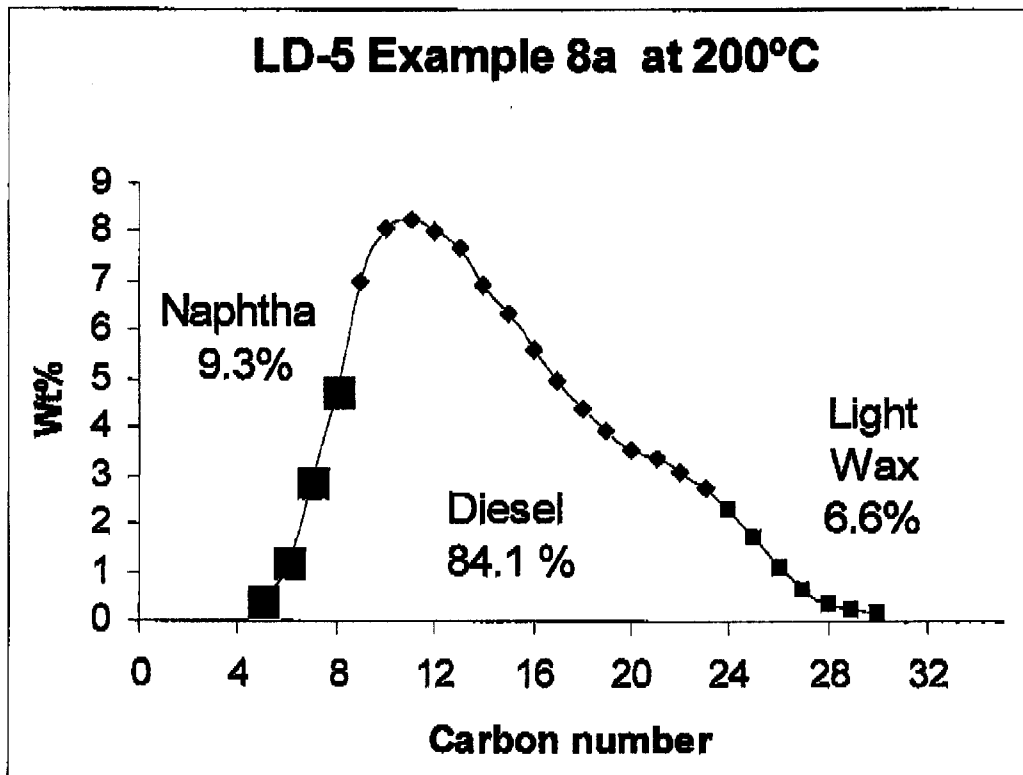

FIGURE 7

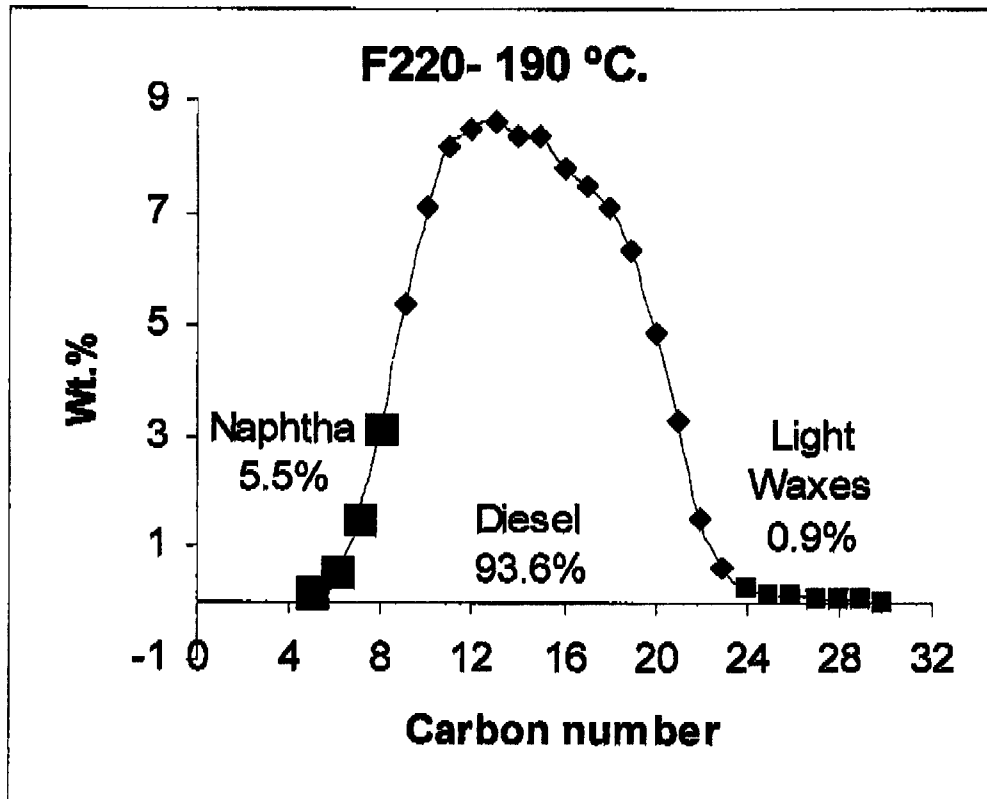
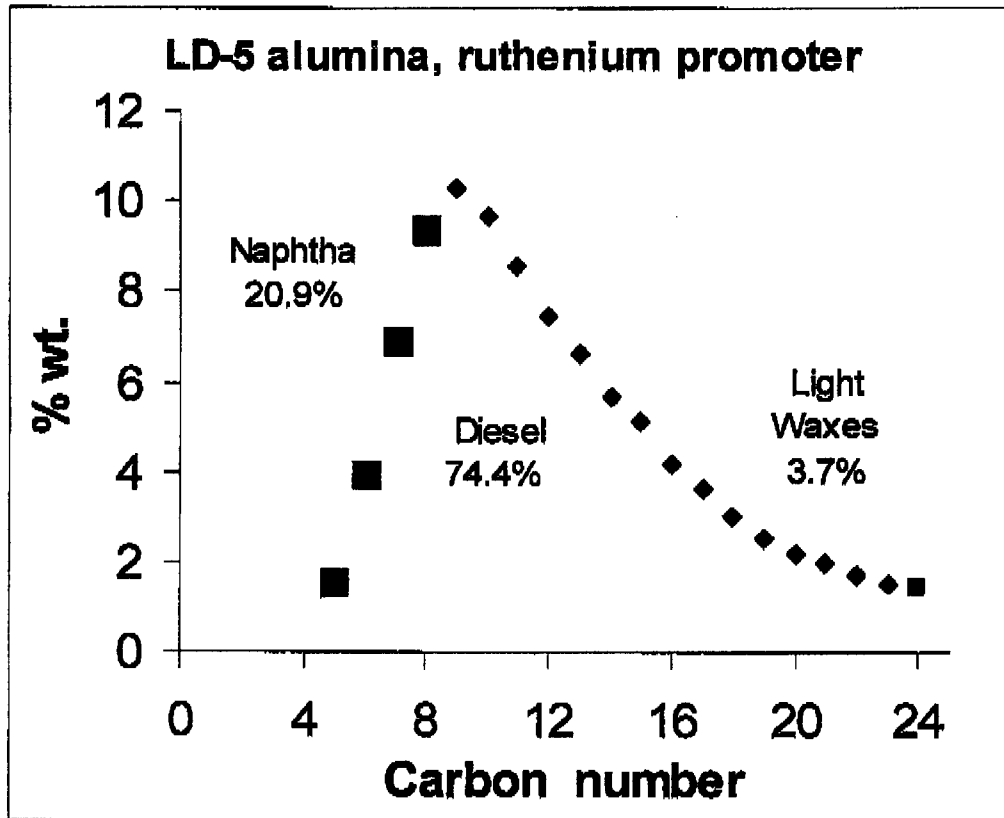

FIGURE 8



9/11

FIGURE 9

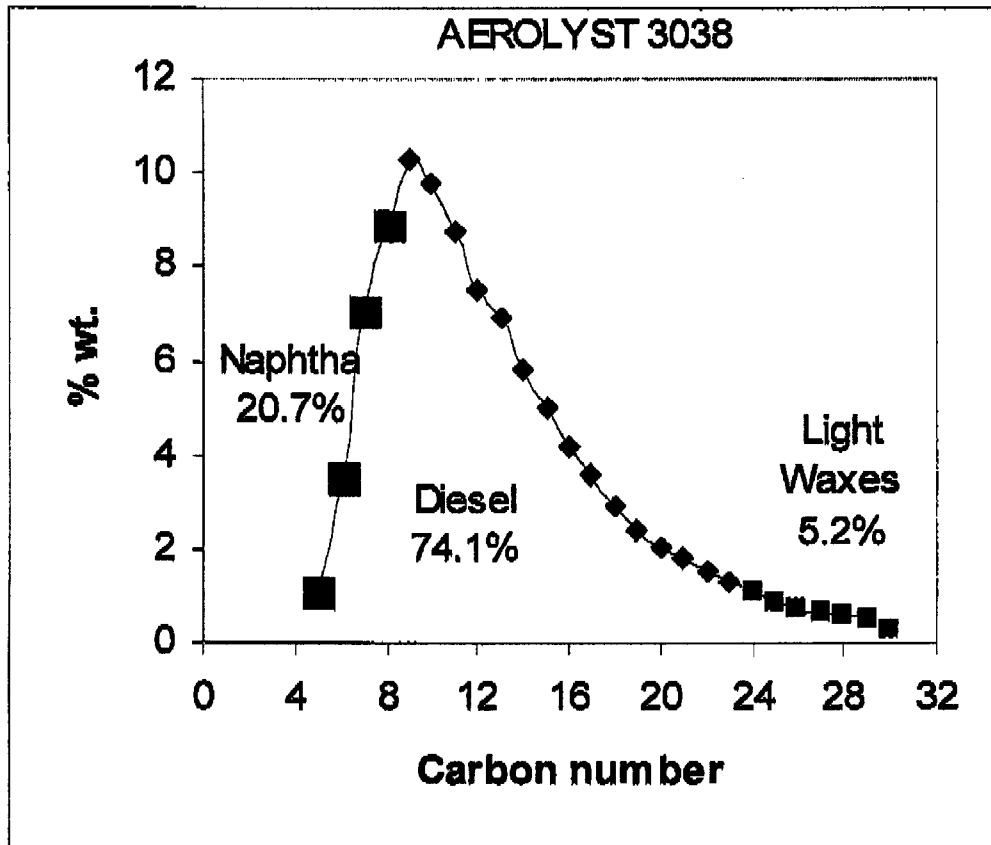

FIGURE 10

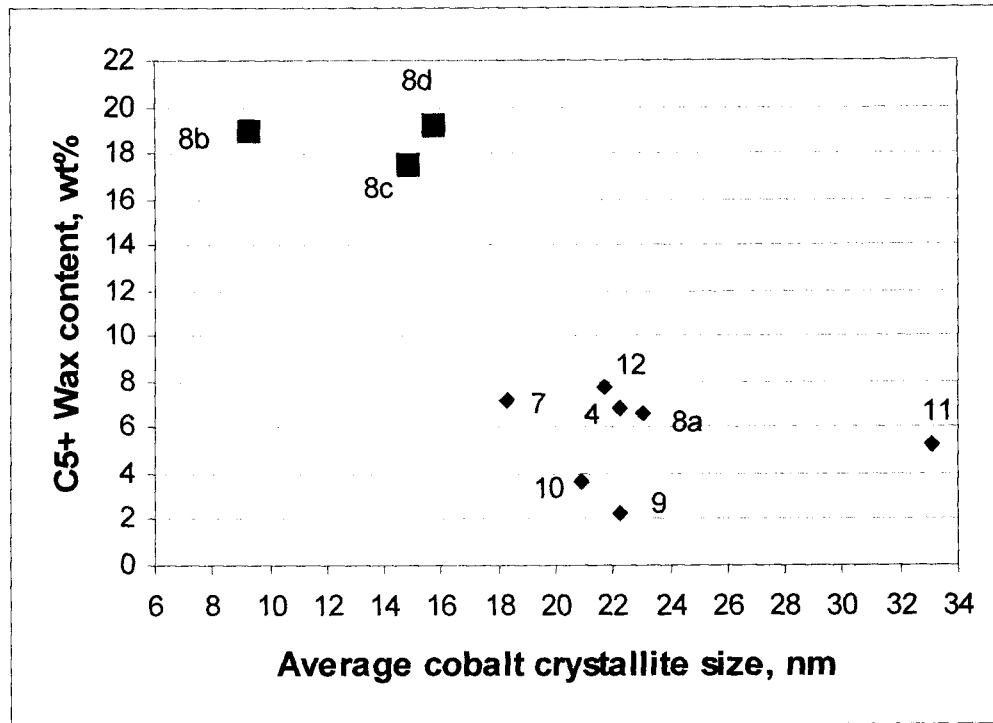
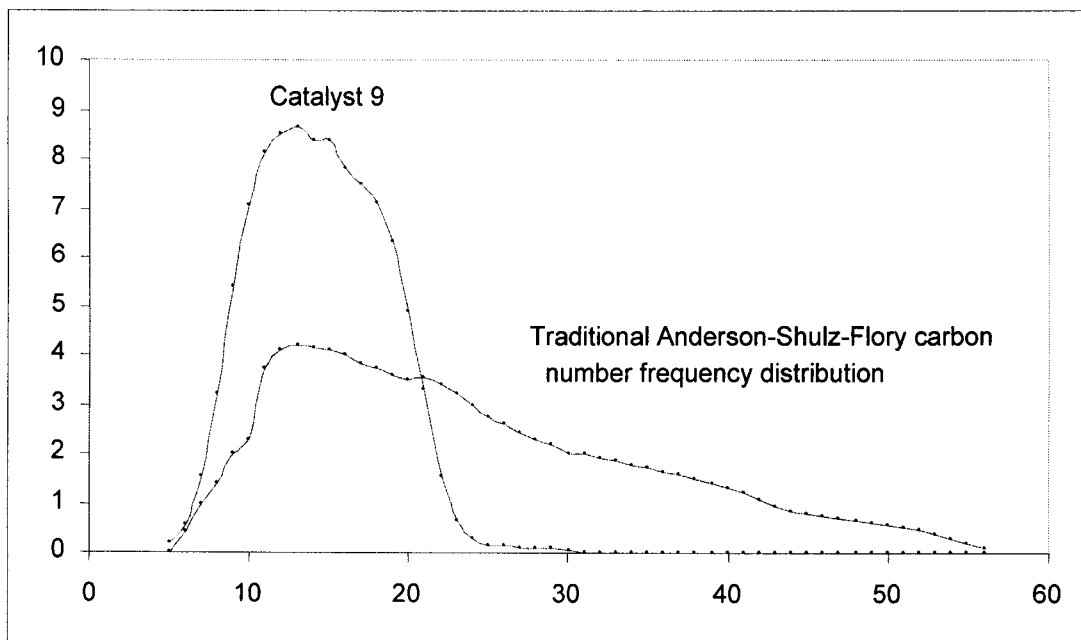

FIGURE 11



INTERNATIONAL SEARCH REPORT

International application No.
PCT/CA2009/001862

<p>A. CLASSIFICATION OF SUBJECT MATTER IPC: <i>C10G 2/00</i> (2006.01), <i>C07C 1/04</i> (2006.01), <i>C10L 1/08</i> (2006.01) According to International Patent Classification (IPC) or to both national classification and IPC</p>		
<p>B. FIELDS SEARCHED</p>		
<p>Minimum documentation searched (classification system followed by classification symbols) IPC: <i>C10G 2/00</i> (2006.01), <i>C07C 1/04</i> (2006.01), <i>C10L 1/08</i> (2006.01)</p>		
<p>Documentation searched other than minimum documentation to the extent that such documents are included in the fields searched</p>		
<p>Electronic database(s) consulted during the international search (name of database(s) and, where practicable, search terms used) Canadian Patent Database, Delphion (all databases), QWeb (fampat)</p>		
<p>C. DOCUMENTS CONSIDERED TO BE RELEVANT</p>		
Category*	Citation of document, with indication, where appropriate, of the relevant passages	Relevant to claim No.
X	CA 2,567,425 A1 (Ayasse) 08 May 2008 (08-05-2008) *whole document*	1-35
X	US 2005/0119116 A1 (Espinoza et. al) 02 June 2005 (02-06-2005) *paragraphs 0024, 0061-0069 and 0105-0112*	1-35
X Y	US 7,452,844 B2 (Hu et al.) 18 November 2008 (18-11-2008) *column 2, lines 26-48; and column 4*	1-3 and 5 4 and 6-35
Y	<u>Handbook of Petroleum Refining Processes, Third Edition</u> (Weick et al. and Schrauwen), McGraw-Hill, 2004 *chapters 15.2 and 15.3*	4 and 6-35
<p><input checked="" type="checkbox"/> Further documents are listed in the continuation of Box C. <input checked="" type="checkbox"/> See patent family annex.</p>		
<p>* Special categories of cited documents :</p> <p>“A” document defining the general state of the art which is not considered to be of particular relevance</p> <p>“E” earlier application or patent but published on or after the international filing date</p> <p>“L” document which may throw doubts on priority claim(s) or which is cited to establish the publication date of another citation or other special reason (as specified)</p> <p>“O” document referring to an oral disclosure, use, exhibition or other means</p> <p>“P” document published prior to the international filing date but later than the priority date claimed</p>	<p>“T” later document published after the international filing date or priority date and not in conflict with the application but cited to understand the principle or theory underlying the invention</p> <p>“X” document of particular relevance; the claimed invention cannot be considered novel or cannot be considered to involve an inventive step when the document is taken alone</p> <p>“Y” document of particular relevance; the claimed invention cannot be considered to involve an inventive step when the document is combined with one or more other such documents, such combination being obvious to a person skilled in the art</p> <p>“&” document member of the same patent family</p>	
<p>Date of the actual completion of the international search 3 February 2010 (03-02-2010)</p>		<p>Date of mailing of the international search report 31 March 2010 (31-03-2010)</p>
<p>Name and mailing address of the ISA/CA Canadian Intellectual Property Office Place du Portage I, C114 - 1st Floor, Box PCT 50 Victoria Street Gatineau, Quebec K1A 0C9 Facsimile No.: 001-819-953-2476</p>		<p>Authorized officer Mary Fawcett Pearce (819) 997-2484</p>

INTERNATIONAL SEARCH REPORT

International application No.
PCT/CA2009/001862

C (Continuation). DOCUMENTS CONSIDERED TO BE RELEVANT

Category*	Citation of document, with indication, where appropriate, of the relevant passages	Relevant to claim No.
X, P, &	US 2009/0124713 A1 (Ayasse) 14 May 2009 (14-05-2009) *whole document*	1-35

Box No. II Observations where certain claims were found unsearchable (Continuation of item 2 of the first sheet)

This international search report has not been established in respect of certain claims under Article 17(2)(a) for the following reasons :

1. Claim Nos. :
because they relate to subject matter not required to be searched by this Authority, namely :

2. Claim Nos. :
because they relate to parts of the international application that do not comply with the prescribed requirements to such an extent that no meaningful international search can be carried out, specifically :

3. Claim Nos. :
because they are dependent claims and are not drafted in accordance with the second and third sentences of Rule 6.4(a).

Box No. III Observations where unity of invention is lacking (Continuation of item 3 of first sheet)

This International Searching Authority found multiple inventions in this international application, as follows :

The specification contains a plurality of independent claims. For unity to exist between said claims, a special technical feature linking the subject matter of these claims must be present. A common feature between all the claims is a Fischer-Tropsch process using a cobalt catalyst with crystallites, said crystallites having an average diameter greater than 16 nanometers. An *a posteriori* analysis has concluded that said common feature is not new and therefore it is not a special technical feature that defines a contribution over the prior art.

1. As all required additional search fees were timely paid by the applicant, this international search report covers all searchable claims.
2. As all searchable claims could be searched without effort justifying additional fees, this Authority did not invite payment of additional fees.
3. As only some of the required additional search fees were timely paid by the applicant, this international search report covers only those claims for which fees were paid, specifically claim Nos. :
4. No required additional search fees were timely paid by the applicant. Consequently, this international search report is restricted to the invention first mentioned in the claims; it is covered by claim Nos. :

- Remark on Protest** The additional search fees were accompanied by the applicant's protest and, where applicable, the payment of a protest fee.
- The additional search fees were accompanied by the applicant's protest but the applicable protest fee was not paid within the time limit specified in the invitation.
- No protest accompanied the payment of additional search fees.

INTERNATIONAL SEARCH REPORT
Information on patent family members

International application No.
PCT/CA2009/001862

Patent Document Cited in Search Report	Publication Date	Patent Family Member(s)	Publication Date
CA2567425A1	08-05-2008	US2008108716A1	08-05-2008
		US2009111900A1	30-04-2009
		US2009124713A1	14-05-2009
		WO2008055353A1	15-05-2008
<hr/>			
US2005119116A1	02-06-2005	US7541310B2	02-06-2009
		WO2005046855A2	26-05-2005
<hr/>			
US7452844B2	18-11-2008	CN1522178A	18-08-2004
		CN100534615C	02-09-2009
		EP1392432A1	03-03-2004
		JP2004528176T	16-09-2004
		RU2292238C2	27-01-2007
		RU2003133445A	10-05-2005
		US7585812B2	08-09-2009
		US2007099797A1	03-05-2007
		US2009036296A1	05-02-2009
		WO02089978A1	14-11-2002
ZA200309032A	17-09-2004		
<hr/>			
US2009124713A1	14-05-2009	CA2567425A1	08-05-2008
		US2008108716A1	08-05-2008
		US2009111900A1	30-04-2009
		WO2008055353A1	15-05-2008
<hr/>			