



(12) **United States Design Patent**
Lyons et al.

(10) **Patent No.:** **US D722,490 S**
(45) **Date of Patent:** **** Feb. 17, 2015**

(54) **SINK CLIP**

- (71) Applicant: **Lyons Industries, Inc.**, Dowagiac, MI (US)
- (72) Inventors: **Lance Dale Lyons**, Dowagiac, MI (US); **Dale Allan Kehoe, II**, Elkhart, IN (US); **Richard Alexander Xouris**, Granger, IN (US); **Jerry Ted Pruszynski**, Granger, IN (US); **Bruce Miller**, Bristol, IN (US); **Allen Francis Elliott**, Berrien Springs, MI (US); **Paul William Emerson**, Dowagiac, MI (US); **Lisa Jo Laubach**, Edwardsburg, MI (US); **Fabiola Pliego Perez-Dussia**, Holland, MI (US)
- (73) Assignee: **Lyons Industries, Inc.**, Dowagiac, MI (US)

(**) Term: **14 Years**

(21) Appl. No.: **29/467,361**

(22) Filed: **Sep. 18, 2013**

(51) **LOC (10) Cl.** **08-08**

(52) **U.S. Cl.**
USPC **D8/395**

(58) **Field of Classification Search**
USPC D8/354, 356, 371, 394-396; D19/65, D19/86; D24/128; 248/74.2, 215, 227.1, 49, 248/300, 301, 316.7, 51, 489; 24/570, 3.12; D32/61; D11/78.1; D3/215

See application file for complete search history.

(56) **References Cited**

U.S. PATENT DOCUMENTS

D54,667	S	*	3/1920	Moore et al.	D30/151
3,021,581	A	*	2/1962	Cook et al.	24/457
3,684,223	A	*	8/1972	Logsdon	248/74.3
D269,155	S	*	5/1983	Rose	D8/356
D295,521	S	*	5/1988	Mockett	D13/155
D305,297	S	*	1/1990	O'Neill	D9/434
D328,187	S	*	7/1992	Saurette	D9/434
D340,857	S	*	11/1993	Light	D8/395
D376,535	S	*	12/1996	Gary et al.	D8/395
D381,484	S	*	7/1997	Clendenning	D32/54
5,953,873	A	*	9/1999	Livingston et al.	52/222
6,273,255	B1	*	8/2001	Rosler	206/378
6,450,338	B1	*	9/2002	Chen	206/378
D521,367	S	*	5/2006	Blanton	D8/395
D537,329	S	*	2/2007	Blanton	D8/395
D584,943	S	*	1/2009	Kerr	D8/394
D600,544	S	*	9/2009	Klaus et al.	D8/395
D628,468	S	*	12/2010	Camp et al.	D8/395
D669,773	S	*	10/2012	Colasse	D8/395
D698,217	S	*	1/2014	Waddell	D8/72

* cited by examiner

Primary Examiner — John Windmuller
(74) *Attorney, Agent, or Firm* — Faegre Baker Daniels LLP

(57) **CLAIM**
The ornamental design for a sink clip, as shown.

DESCRIPTION

FIG. 1 is a perspective view of a sink clip in accordance with the subject invention;
FIG. 2 is a side view of the sink clip of FIG. 1;
FIG. 3 is an opposite side view of the sink clip of FIG. 1;
FIG. 4 is a top plan view of the sink clip of FIG. 1;
FIG. 5 is a bottom plan view of the sink clip of FIG. 1;
FIG. 6 is a rear view of the sink clip of FIG. 1; and
FIG. 7 is a front view of the sink clip of FIG. 1.

1 Claim, 3 Drawing Sheets

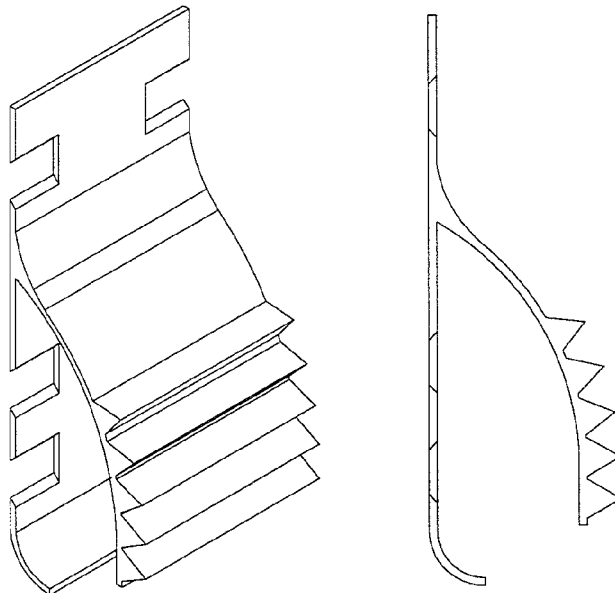

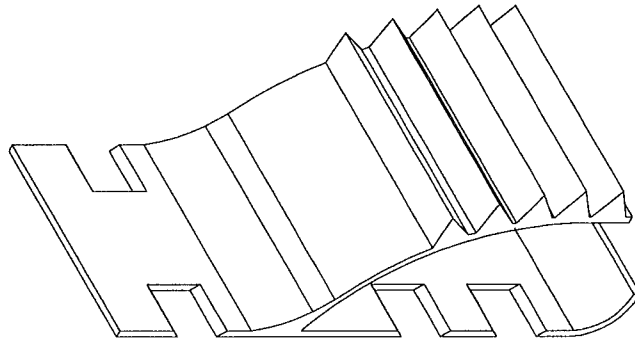

FIG. 1

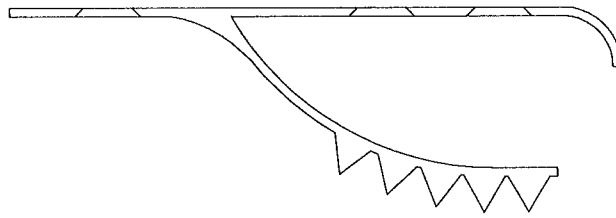

FIG. 3

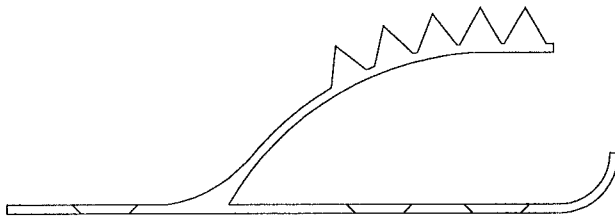

FIG. 2

FIG. 4

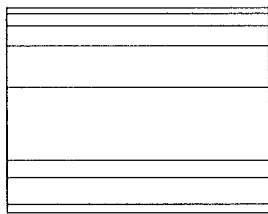

FIG. 5

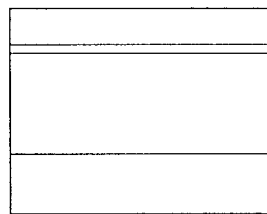

FIG. 7

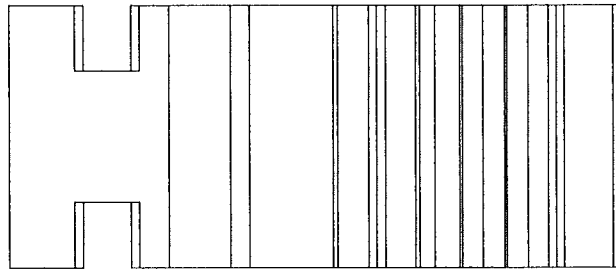

FIG. 6

