



US00D744038S

(12) **United States Design Patent**  
**Wang**

(10) **Patent No.:** **US D744,038 S**

(45) **Date of Patent:** **\*\* Nov. 24, 2015**

(54) **CHALK**

(71) Applicant: **Xiaoyan Wang**, Shangrao (CN)

(72) Inventor: **Xiaoyan Wang**, Shangrao (CN)

(\*\*) Term: **14 Years**

(21) Appl. No.: **29/501,255**

(22) Filed: **Sep. 3, 2014**

(30) **Foreign Application Priority Data**

Aug. 7, 2014 (CN) ..... 2014 3 0277186

(51) **LOC (10) Cl.** ..... **19-06**

(52) **U.S. Cl.**

USPC ..... **D19/182**; D19/912; D19/917

(58) **Field of Classification Search**

USPC ..... D8/98, 99; D14/411; D19/115-204;

D28/7; D10/119.3, 119.4

CPC ..... B43K 5/005; B43K 7/00; B43K 7/01;

B43K 7/10; B43K 7/12; B43K 19/00; B43K

19/02; B43K 8/04; B43K 19/14; B43K

23/016; B43K 19/003

See application file for complete search history.

(56) **References Cited**

**U.S. PATENT DOCUMENTS**

D60,192 S \* 1/1922 Mason, Jr. .... D19/46

D323,683 S \* 2/1992 Isaacs ..... D21/440

D383,162 S *	9/1997	Worther	.....	D19/173
D500,799 S *	1/2005	Olson	.....	D10/78
D552,175 S *	10/2007	Boerio	.....	D19/175
D587,310 S *	2/2009	Paslowski	.....	D19/185
D619,580 S *	7/2010	Nakayama et al.	.....	D14/411
D641,755 S *	7/2011	Rashid et al.	.....	D14/411
D675,621 S *	2/2013	Fletcher et al.	.....	D14/411
D688,665 S *	8/2013	Huang	.....	D14/411
D695,741 S *	12/2013	Wang	.....	D14/411
D706,267 S *	6/2014	Nakata	.....	D14/411
D709,886 S *	7/2014	Lin	.....	D14/411

\* cited by examiner

*Primary Examiner* — Elizabeth Albert

(74) *Attorney, Agent, or Firm* — Matthias Scholl, PC;  
Matthias Scholl

(57) **CLAIM**

The ornamental design for chalk, as shown and described.

**DESCRIPTION**

FIG. 1 is a front elevational view of chalk;  
FIG. 2 is a rear elevational view thereof;  
FIG. 3 is a left side elevational view thereof;  
FIG. 4 is a right side elevational view thereof;  
FIG. 5 is a top plan view thereof;  
FIG. 6 is a bottom plan view thereof; and,  
FIG. 7 is a perspective view thereof.

**1 Claim, 7 Drawing Sheets**

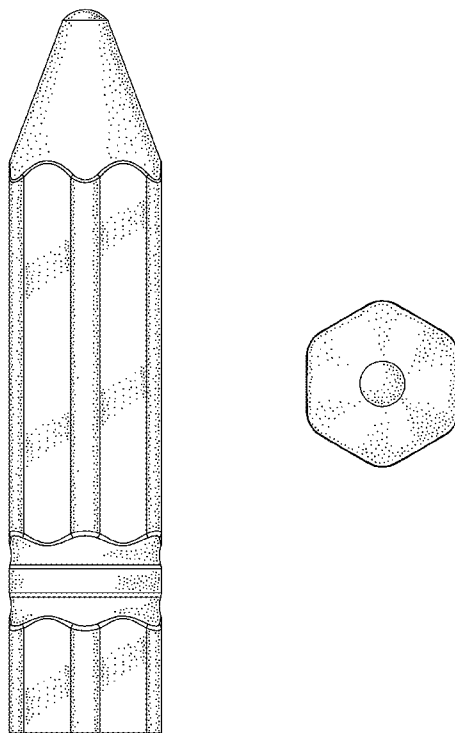

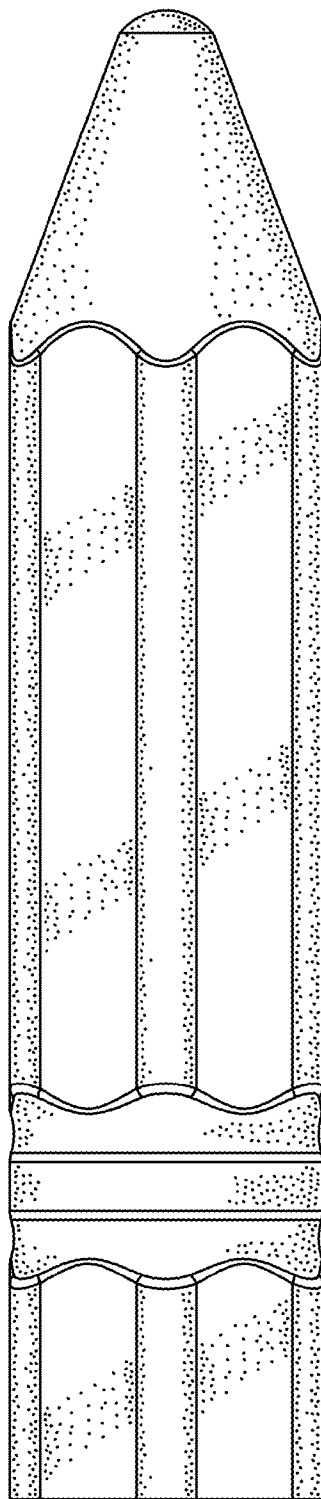

FIG. 1

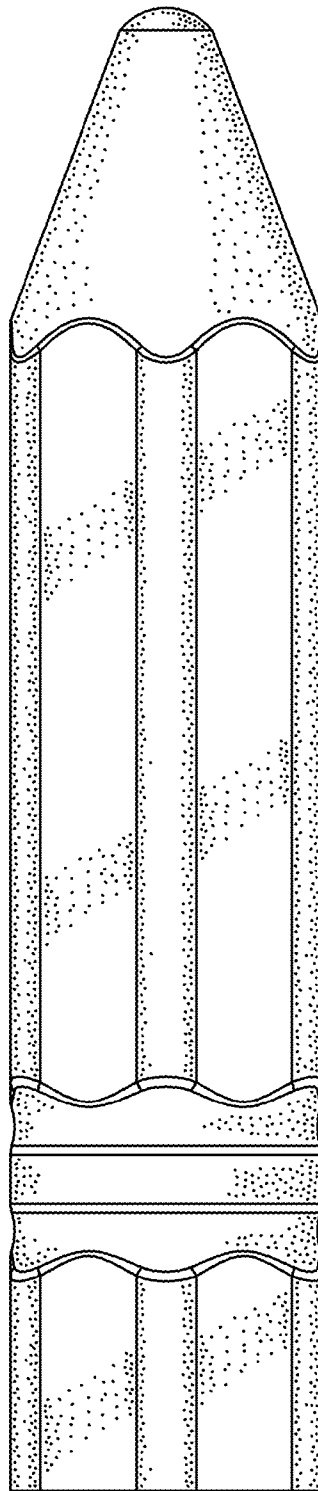

FIG. 2

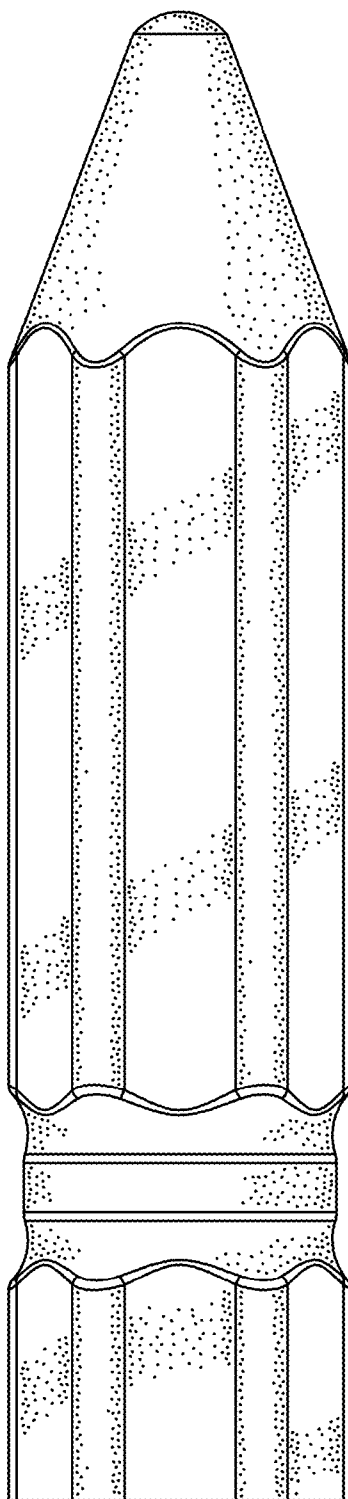

FIG. 3

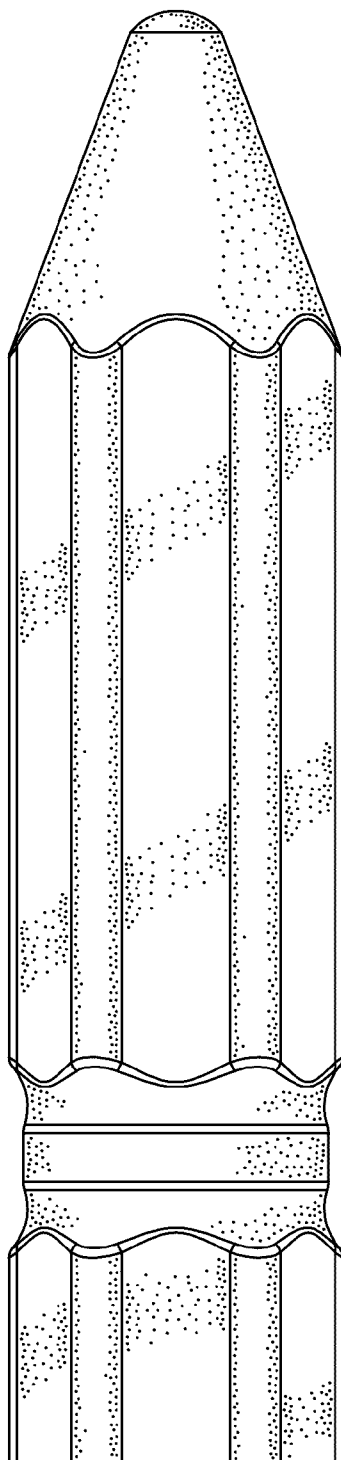

FIG. 4

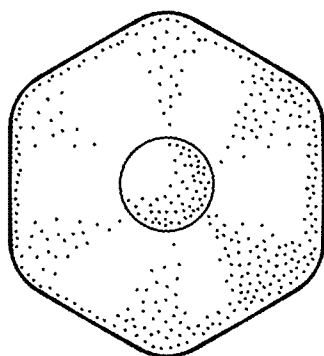

FIG. 5

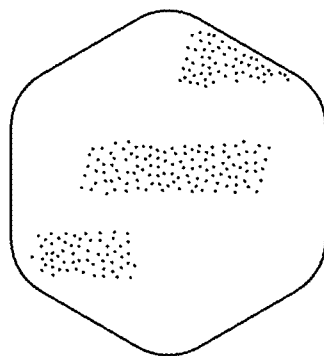

FIG. 6

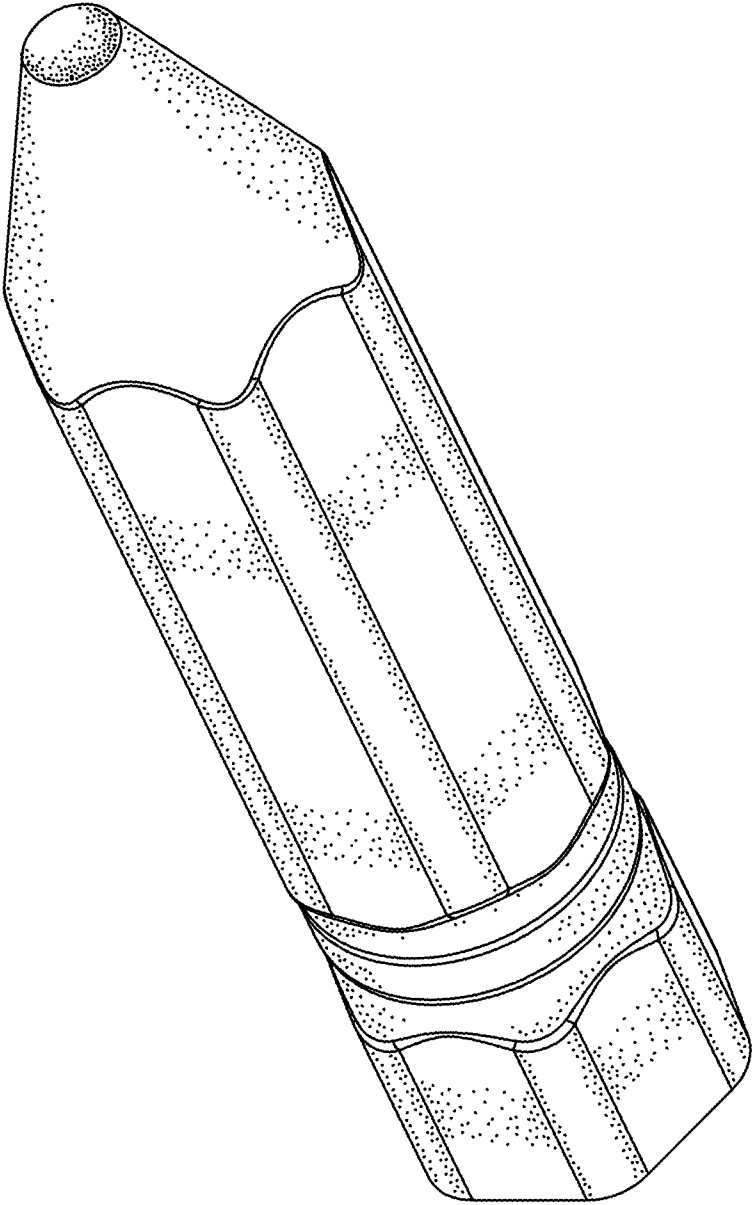

FIG. 7