



US0D1011432S

(12) **United States Design Patent**  
**Schoonmaker et al.**

(10) **Patent No.:** **US D1,011,432 S**  
(45) **Date of Patent:** **\*\* Jan. 16, 2024**

- (54) **GAMING MACHINE INCLUDING LIGHT BAR**
- (71) Applicant: **Aristocrat Technologies, Inc.**, Las Vegas, NV (US)
- (72) Inventors: **Rena Schoonmaker**, Las Vegas, NV (US); **Timothy Seckel**, Streamwood, IL (US); **James McNierney**, Las Vegas, NV (US); **Bruce Urban**, Las Vegas, NV (US)
- (73) Assignee: **Aristocrat Technologies, Inc.**, Las Vegas, NV (US)
- (\*\*) Term: **15 Years**
- (21) Appl. No.: **29/868,373**
- (22) Filed: **Nov. 30, 2022**

**Related U.S. Application Data**

- (62) Division of application No. 29/735,069, filed on May 18, 2020, now Pat. No. Des. 973,778.
- (51) **LOC (14) Cl.** ..... **21-01**
- (52) **U.S. Cl.**  
USPC ..... **D21/369**
- (58) **Field of Classification Search**  
USPC ..... D6/657, 662, 661, 663, 664.1, 667, 668, D6/669, 671, 671.1, 671.2, 672, 673; D14/129, 126, 127, 128, 138 G, 172, 248, D14/307, 325, 341, 371, 374, 375, 401, D14/432, 439, 450; D21/325, 329, 369, D21/371, 370, 385, 394; D25/48.7  
CPC ..... G07F 17/3216; G07F 17/3211; G07F 17/3267; G07F 17/3213; G07F 17/34; G07F 17/3244  
See application file for complete search history.

**References Cited**

**U.S. PATENT DOCUMENTS**

D213,676 S 4/1969 Biro  
D398,597 S 9/1998 Morioka

6,186,894 B1	2/2001	Mayeroff
D498,267 S	11/2004	Crouch
7,029,396 B2	4/2006	Jaffe
D560,724 S	1/2008	Johnson
D560,725 S	1/2008	Johnson
D623,657 S	9/2010	Fitzmaurice
D626,560 S	11/2010	Fitzmaurice
D627,366 S	11/2010	Martiros
D629,420 S	12/2010	O'Donnell
7,988,549 B2	8/2011	Little
D646,336 S	10/2011	Kelly
D646,337 S	10/2011	Kelly
D646,695 S	10/2011	Hoggarth
D653,261 S	1/2012	Ikenoue
8,123,612 B2	2/2012	Yoshizawa
8,328,619 B2	12/2012	Nagano
D678,323 S	3/2013	Yoshida
D678,903 S	3/2013	Yoshida
8,388,435 B2	3/2013	Anderson
D685,033 S	6/2013	Wudtke
8,475,261 B2	7/2013	Little
D704,735 S	5/2014	Hollobaugh
D706,741 S	6/2014	Myers
D710,882 S	8/2014	Francisco
D712,975 S	9/2014	Lesley
D715,323 S	10/2014	Umezawa
D719,615 S	12/2014	Inoue
D719,616 S	12/2014	Inoue
D720,771 S	1/2015	Lacour
D728,621 S	5/2015	Jou
D732,072 S	6/2015	Ying
D733,088 S	6/2015	Garneau
D736,752 S	8/2015	Lee
D737,320 S	8/2015	McCormick
9,105,147 B2	8/2015	Nagano
D740,888 S	10/2015	DePalma
D741,368 S	10/2015	Supino
D742,975 S	11/2015	Myers
D748,123 S	1/2016	Schwengler
9,245,418 B2	1/2016	Mitchell
D751,098 S	3/2016	Lim
D760,239 S	6/2016	Hirai
D761,804 S	7/2016	Hirai
D762,241 S	7/2016	Loosli
D762,613 S	8/2016	Garneau
RE46,169 E	10/2016	Kelly
D769,260 S	10/2016	Kim
D769,325 S	10/2016	Casalegno
D771,041 S	11/2016	Bae
D774,032 S	12/2016	Bae
D776,157 S	1/2017	Lajoie
D776,161 S	1/2017	Tursi
D784,399 S	4/2017	Herrera

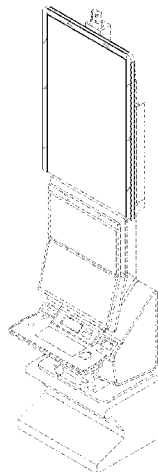

US D1,011,432 S

D786,928 S	5/2017	Lee		D896,315 S	9/2020	Castro	
9,679,435 B2 *	6/2017	Schrementi .....	G07F 17/3213	D898,127 S	10/2020	Bristol	
D792,454 S	7/2017	Baumez		D898,128 S	10/2020	Urban	
D794,672 S	8/2017	Hirai		D902,319 S *	11/2020	Hohman .....	D21/369
D795,884 S	8/2017	Kim		D904,522 S	12/2020	Holland	
D812,146 S	3/2018	Castro		D904,915 S	12/2020	Gong	
D812,147 S	3/2018	Castro		D905,172 S	12/2020	Boese	
D812,148 S	3/2018	Castro		D905,730 S	12/2020	Newsom	
D812,149 S	3/2018	Castro		D906,432 S	12/2020	Johnson	
D818,048 S	5/2018	Calhoun		D906,433 S	12/2020	Abele	
D819,694 S	6/2018	Kim		D907,120 S	1/2021	DeMarco	
D819,747 S	6/2018	Castro		D907,121 S	1/2021	DeMarco	
D820,915 S	6/2018	Lee		D907,122 S	1/2021	DeMarco	
D822,117 S	7/2018	Costa		D907,123 S	1/2021	Alexander	
D829,222 S	9/2018	Choi		D907,125 S	1/2021	Abele	
D832,355 S	10/2018	Castro		D907,126 S	1/2021	Abele	
D832,356 S	10/2018	Castro		D907,707 S	1/2021	DeMarco	
D832,357 S	10/2018	Castro		D907,708 S	1/2021	DeMarco	
D836,164 S	12/2018	Castro		D907,709 S	1/2021	DeMarco	
10,181,236 B2	1/2019	Goldstein		D907,710 S	1/2021	DeMarco	
D842,337 S	3/2019	Pudipeddi		D907,711 S	1/2021	DeMarco	
D842,930 S	3/2019	Johnson		D907,712 S	1/2021	DeMarco	
D842,932 S	3/2019	Stair		D907,714 S	1/2021	Alexander	
D842,933 S	3/2019	Castro		D907,715 S	1/2021	Abele	
D843,458 S	3/2019	Castro		D907,716 S	1/2021	DeMarco	
D843,459 S	3/2019	Castro		D908,171 S	1/2021	DeMarco	
D843,460 S	3/2019	Castro		D908,172 S	1/2021	DeMarco	
D843,461 S	3/2019	Castro		D908,173 S	1/2021	DeMarco	
D843,464 S	3/2019	Castro		D908,712 S	1/2021	Fischbach	
D843,465 S	3/2019	Castro		D908,802 S	1/2021	Holland	
D843,467 S	3/2019	Johnson		D909,399 S	2/2021	La Guardia	
D843,468 S	3/2019	Johnson		D909,479 S	2/2021	Abele	
D843,469 S	3/2019	Nettenstrom		D910,117 S	2/2021	DeMarco	
D843,473 S	3/2019	Zedell, Jr.		D910,118 S	2/2021	DeMarco	
D843,474 S	3/2019	Lesley		D910,119 S	2/2021	DeMarco	
D843,475 S	3/2019	Lesley		D910,120 S	2/2021	DeMarco	
D843,476 S	3/2019	Lesley		D910,761 S	2/2021	Glenn, II	
D843,477 S	3/2019	Lesley		D910,762 S	2/2021	DeMarco	
D843,478 S	3/2019	Lesley		D910,763 S	2/2021	DeMarco	
D843,479 S	3/2019	Castro		D911,451 S	2/2021	Ortiz De Viveiros	
D843,480 S	3/2019	Castro		D913,378 S	3/2021	Glenn, II	
D843,482 S	3/2019	Holland		D913,379 S	3/2021	Calhoun	
D844,062 S	3/2019	Lesley		D914,808 S	3/2021	Loong	
D844,656 S	4/2019	Toth		D915,523 S	4/2021	Glenn, II	
D846,650 S	4/2019	Stair		D918,300 S	5/2021	DeMarco	
D850,536 S	6/2019	Stair		D918,303 S	5/2021	DeMarco	
D852,830 S	7/2019	Penacho		11,011,015 B2	5/2021	Achmueller	
D862,602 S	10/2019	Kariya		D923,102 S	6/2021	McGahn	
D866,667 S	11/2019	Stair		11,132,861 B2	9/2021	Nelson	
D868,165 S *	11/2019	Ortiz De Viveiros .....	D21/369	D934,347 S	10/2021	Ocampo	
D868,714 S	12/2019	Hodgson		D934,955 S	11/2021	Van Linden	
D870,138 S	12/2019	Penacho		D936,150 S	11/2021	Bussey	
D870,820 S	12/2019	Urban		D937,354 S *	11/2021	Glenn, II .....	D21/369
D871,419 S	12/2019	Hu		D937,355 S *	11/2021	Olive .....	D21/369
D871,506 S	12/2019	Castro		D939,025 S	12/2021	Bruzzese	
D871,507 S	12/2019	Urban		11,217,059 B2	1/2022	Onitsuka	
D872,190 S	1/2020	Zedell, Jr.		D943,027 S *	2/2022	Ortiz De Viveiros .....	D21/369
D877,810 S	3/2020	Nelson		D943,028 S *	2/2022	Ortiz de Viveiros .....	D21/369
D880,606 S	4/2020	Glenn, II		D943,029 S *	2/2022	Francisco .....	D21/369
D880,608 S	4/2020	Glenn, II		D944,330 S *	2/2022	Ortiz De Viveiros .....	D21/369
D880,610 S	4/2020	Glenn, II		D946,661 S *	3/2022	Thompson .....	D21/369
D881,285 S	4/2020	Glenn		11,288,916 B2	3/2022	Coon	
D882,696 S	4/2020	Lesley		D952,751 S	5/2022	Kulujian	
D882,697 S	4/2020	Lesley		D952,753 S	5/2022	Kulujian	
D882,698 S	4/2020	Lesley		D952,755 S	5/2022	Kulujian	
D884,079 S	5/2020	Glenn, II		11,348,400 B2	5/2022	Coon	
D889,546 S	7/2020	Jones		D954,844 S *	6/2022	Rosander .....	D21/369
D890,264 S	7/2020	Johnson		D954,845 S	6/2022	Johnson	
D890,265 S *	7/2020	Johnson .....	D21/369	D958,888 S *	7/2022	DeMarco .....	D21/325
D890,552 S	7/2020	Case		D959,562 S *	8/2022	Edwards .....	D21/370
D890,790 S	7/2020	Marks		D964,471 S	9/2022	Holland	
D890,849 S	7/2020	Johnson		D969,926 S	11/2022	Lewis	
D890,850 S	7/2020	Johnson		D969,927 S	11/2022	Lee	
D893,631 S	8/2020	Glinka		D969,928 S	11/2022	Lamb	
D894,285 S	8/2020	Glenn, II		D974,472 S	1/2023	Colvin	
D895,019 S	9/2020	Lesley		D977,014 S	1/2023	Bussey	
D896,312 S	9/2020	Castro		2002/0119814 A1	8/2002	Fong	
D896,313 S	9/2020	Castro		2002/0183105 A1	12/2002	Cannon	
D896,314 S	9/2020	Castro		2004/0048646 A1	3/2004	Visocnik	

2004/0204227	A1	10/2004	Johnson
2005/0043083	A1	2/2005	Inoue
2005/0059475	A1	3/2005	Breen
2005/0215311	A1	9/2005	Hornik
2005/0282615	A1	12/2005	Englman
2005/0288094	A1	12/2005	Marks
2007/0287529	A1	12/2007	Kojima
2010/0210343	A1	8/2010	Englman
2011/0207530	A1	8/2011	Chudek
2013/0116809	A1	5/2013	Carpenter
2014/0094303	A1	4/2014	Wabschall
2014/0256409	A1	9/2014	Wood
2015/0099568	A1	4/2015	Elias
2016/0086435	A1	3/2016	Hughes
2016/0092065	A1	3/2016	Hilbert
2016/0093143	A1	3/2016	Lamb
2016/0093145	A1	3/2016	Kitamura
2016/0140795	A1	5/2016	Fong
2017/0039802	A1	2/2017	Prabhu
2017/0061743	A1	3/2017	Itagaki
2017/0092066	A1	3/2017	Watkins
2017/0221313	A1	8/2017	Basallo
2018/0040191	A1	2/2018	Tran
2018/0053373	A1	2/2018	Goldstein
2018/0075689	A1	3/2018	Castro
2018/0078854	A1	3/2018	Achmueller
2018/0190068	A1	7/2018	Priddy
2018/0330568	A1	11/2018	Glenn
2018/0342129	A1	11/2018	Wudtke
2019/0012874	A1	1/2019	Goldstein
2019/0066445	A1	2/2019	Satterlie
2019/0096161	A1	3/2019	Barbour
2019/0096166	A1	3/2019	Shimizu
2019/0096170	A1*	3/2019	Lewis ..... G07F 17/3211
2019/0197818	A1	6/2019	Rosander
2019/0197824	A1	6/2019	Timperley
2019/0244488	A1	8/2019	Marsh
2019/0295380	A1	9/2019	Casey
2020/0111295	A1	4/2020	Glenn
2020/0111299	A1	4/2020	Baker
2020/0160654	A1	5/2020	Idris
2020/0327779	A1	10/2020	Sanborn
2021/0110642	A1	4/2021	Ocampo
2021/0134109	A1	5/2021	Hemerick
2021/0322595	A1	10/2021	Colvin
2022/0068081	A1	3/2022	Pariseau
2022/0180695	A1	6/2022	Fritz
2022/0245993	A1	8/2022	Soong
2023/0024888	A1	1/2023	Ocampo

FOREIGN PATENT DOCUMENTS

EM	0031804620004	6/2016
EM	0041240300002	7/2017
EM	0085382430003	5/2021

OTHER PUBLICATIONS

“Huge new casino and resort opens near Toronto”, Aug. 5, 2021, Blogto, site visited Aug. 1, 2022: <https://www.blogto.com/city/2021/08/huge-new-casino-and-resort-opens-near-toronto/> (Year: 2021).\*

“Slot machines” Aug. 11, 2020, Encore Boston Harbor, site visited Aug. 1, 2022: <https://www.encorebostonharbor.com/casino/featured-slot-games> (Year: 2020).\*

“How Do I Pick a Good Slot Machine” Mar. 17, 2020, BestUsCasinos, site visited Aug. 2, 2022: <https://www.bestuscasinos.org/blog/how-do-i-pick-good-slot-machine/> (Year: 2020).\*

“Huge Win! Queen of the Nile Deluxe Slot—Max Bet Bonus!,” screenshots of YouTube video, download date Apr. 30, 2019, published on Sep. 5, 2018, 7 pages.  
Office Action dated Oct. 22, 2020 for U.S. Appl. No. 29/686,998 (pp. 1-8).  
Notice of Allowance dated Nov. 4, 2020 for U.S. Appl. No. 16/379,724 (pp. 1-9).  
Notice of Allowance dated Dec. 16, 2020 for U.S. Appl. No. 16/379,724 (pp. 1-2).

Office Action dated Jul. 6, 2020 for U.S. Appl. No. 16/379,724 (pp. 1-10).  
Notice of Allowance dated Jan. 25, 2021 for U.S. Appl. No. 29/686,998 (pp. 1-7).  
Office Action dated Feb. 23, 2021 for U.S. Appl. No. 29/686,999 (pp. 1-6).  
Corrected Notice of Allowability dated Mar. 19, 2021 for U.S. Appl. No. 29/686,998 (pp. 1-2).  
Torsani, Derek. “Animated Buffer Logo.” Dribbble, published Mar. 31, 2015 (Retrieved from the Internet Feb. 17, 2021). Internet URL: <<https://dribbble.com/shots/1998685-Animated-Buffer-Logo>> (Year: 2015).  
GiVe. “Remerge’s CSS loader+ CodePen.” Dribbble, published Nov. 24, 2014 (Retrieved from the Internet Feb. 17, 2021). Internet URL: <<https://dribbble.com/shots/1821741-Remerge-s-CSS-loader-CodePen>> (Year: 2014).  
Notice of Allowance dated Apr. 28, 2021 for U.S. Appl. No. 29/686,999 (pp. 1-6).  
Office Action (Non-Final Rejection) dated Sep. 27, 2021 for U.S. Appl. No. 17/079,400 (pp. 1-11).  
Office Action (Non-Final Rejection) dated Sep. 23, 2021 for U.S. Appl. No. 17/248,251 (pp. 1-12).  
MCFM-55—43inch Vertical Type Gaming Machine, first available Jul. 1, 2020, syweb.com [online], site visited Nov. 15, 2021], Available from internet URL: <https://bit.ly/3oxvpLu> (Year: 2020).  
Infinity V55, first available Apr. 23, 2018, youtube.com [online], site visited Nov. 16, 2021], Available from internet URL: <https://www.youtube.com/watch?v=ILy-9J6YkPo> (Year: 2018).  
Office Action (Final Rejection) dated Jan. 28, 2022 for U.S. Appl. No. 17/079,400 (pp. 1-10).  
Office Action (Final Rejection) dated Feb. 24, 2022 for U.S. Appl. No. 17/248,251 (pp. 1-6).  
Office Action dated Mar. 23, 2022 for U.S. Appl. No. 29/735,030 (pp. 1-10).  
Office Action dated Mar. 23, 2022 for U.S. Appl. No. 29/735,035 (pp. 1-10).  
Office Action dated Mar. 17, 2022 for U.S. Appl. No. 29/735,056 (pp. 1-12).  
Office Action dated Mar. 23, 2022 for U.S. Appl. No. 29/735,058 (pp. 1-11).  
Office Action dated Mar. 17, 2022 for U.S. Appl. No. 29/735,063 (pp. 1-12).  
Office Action dated Mar. 23, 2022 for U.S. Appl. No. 29/735,065 (pp. 1-10).  
Office Action dated Mar. 17, 2022 for U.S. Appl. No. 29/735,067 (pp. 1-13).  
Office Action dated Mar. 17, 2022 for U.S. Appl. No. 29/735,069 (pp. 1-12).  
Office Action (Notice of Allowance and Fees Due (PTOL-85)) dated Apr. 6, 2022 for U.S. Appl. No. 17/248,251 (pp. 1-8).  
Office Action (Notice of Allowance and Fees Due (PTOL-85)) dated May 23, 2022 for U.S. Appl. No. 17/248,251 (pp. 1-2).  
Office Action (Notice of Allowance and Fees Due (PTOL-85)) dated Jun. 24, 2022 for U.S. Appl. No. 17/079,400 (pp. 1-8).  
Office Action dated Aug. 19, 2022 for U.S. Appl. No. 29/735,030 (pp. 1-7).  
“Slot machines” Aug. 11, 2020, Encore Boston Harbor, site visited Aug. 1, 2022: <https://www.encorebostonharbor.com/casino/featured-slot-games> (Year: 2020).  
Office Action dated Aug. 22, 2022 for U.S. Appl. No. 29/735,035 (pp. 1-7).  
Office Action dated Aug. 22, 2022 for U.S. Appl. No. 29/735,056 (pp. 1-8).  
Office Action dated Aug. 22, 2022 for U.S. Appl. No. 29/735,058 (pp. 1-8).  
Office Action dated Aug. 22, 2022 for U.S. Appl. No. 29/735,063 (pp. 1-7).  
Notice of Allowance dated Aug. 26, 2022 for U.S. Appl. No. 29/735,065 (pp. 1-8).  
Notice of Allowance dated Aug. 30, 2022 for U.S. Appl. No. 29/735,067 (pp. 1-8).  
Notice of Allowance dated Aug. 29, 2022 for U.S. Appl. No. 29/735,069 (pp. 1-8).

Notice of Allowance dated Nov. 15, 2022 for U.S. Appl. No. 29/735,030 (pp. 1-7).

“Winning big bucks”, Aug. 4, 2021, Youtube, site visited Nov. 1, 2022: <https://www.youtube.com/watch?v=dQeaTYnkCt0> (Year: 2021).

“Discover the Sumptuous Grand Casino Brussels Viage” Nov. 14, 2017, Youtube, site visited Nov. 1, 2022: <https://www.youtube.com/watch?v=LNr5WDi0-rs> (Year: 2017).

Notice of Allowance dated Nov. 15, 2022 for U.S. Appl. No. 29/735,035 (pp. 1-7).

Notice of Allowance dated Nov. 16, 2022 for U.S. Appl. No. 29/735,056 (pp. 1-7).

Notice of Allowance dated Nov. 16, 2022 for U.S. Appl. No. 29/735,058 (pp. 1-8).

Notice of Allowance dated Nov. 14, 2022 for U.S. Appl. No. 29/735,063 (pp. 1-7).

Office Action (Non-Final Rejection) dated Apr. 25, 2023 for U.S. Appl. No. 17/664,388 (pp. 1-8).

Notice of Allowance dated May 25, 2023 for U.S. Appl. No. 29/700,719 (pp. 1-19).

\* cited by examiner

*Primary Examiner* — Jack Reickel

*Assistant Examiner* — Salamah Jordan

(74) *Attorney, Agent, or Firm* — Armstrong Teasdale LLP

(57)

**CLAIM**

We claim the ornamental design for a gaming machine including light bar, as shown and described.

**DESCRIPTION**

The present application is also related to U.S. patent application Ser. No. 29/735,056, filed May 18, 2020, entitled

“Bank of Gaming Machines Including Light Bar,” U.S. patent application Ser. No. 29/735,058, filed May 18, 2020, entitled “Bank of Gaming Machines Including Light Bar,” U.S. patent application Ser. No. 29/735,063, filed May 18, 2020, entitled “Bank of Gaming Machines Including Light Bar,” U.S. patent application Ser. No. 29/735,067, filed May 18, 2020, entitled “Bank of Gaming Machines Including Light Bar,” U.S. patent application Ser. No. 29/735,030, filed May 18, 2020, entitled “Bank Of Gaming Machines Including Light Bar,” U.S. patent application Ser. No. 29/735,035, filed May 18, 2020, entitled “Bank of Gaming Machines Including Light Bar,” and U.S. patent application Ser. No. 29/735,069, filed May 18, 2020, entitled “Gaming Machine Including Light Bar,” the disclosures of which are hereby incorporated by reference in their entireties.

FIG. 1 is a perspective view of a gaming machine including light bar showing the new design;

FIG. 2 is a front view thereof;

FIG. 3 is a rear view thereof;

FIG. 4 is a right side view thereof;

FIG. 5 is a left side view thereof;

FIG. 6 is a top view thereof;

FIG. 7 is a bottom view thereof; and,

FIG. 8 is another front view thereof, illustrating the light bar in an illuminated state.

In these drawings, the solid lines illustrate the claimed ornamental design, whereas broken lines illustrate unclaimed environmental features and form no part of the claimed design. The radiating lines emanating from the light bar in FIG. 8 represent illumination.

**1 Claim, 7 Drawing Sheets**

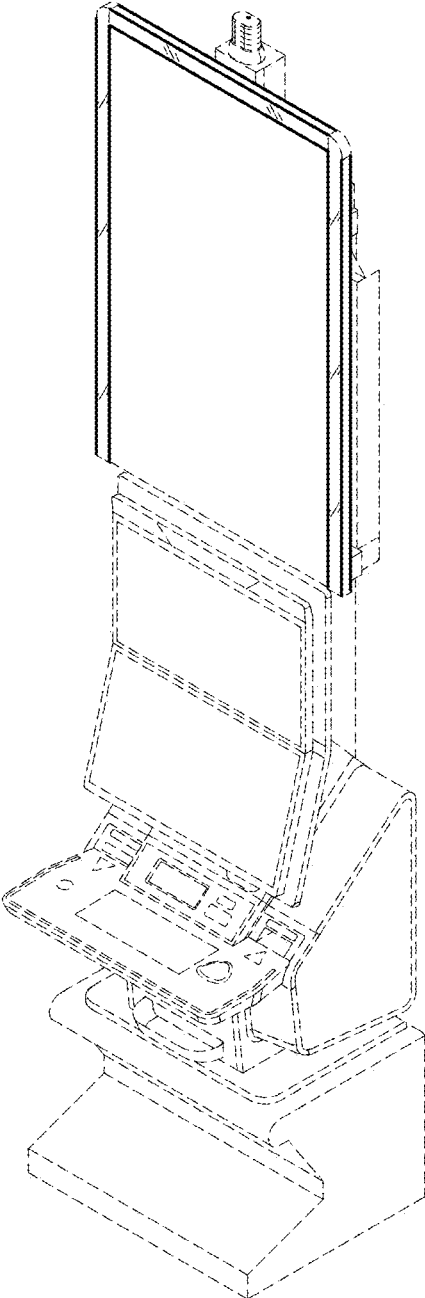

FIG. 1

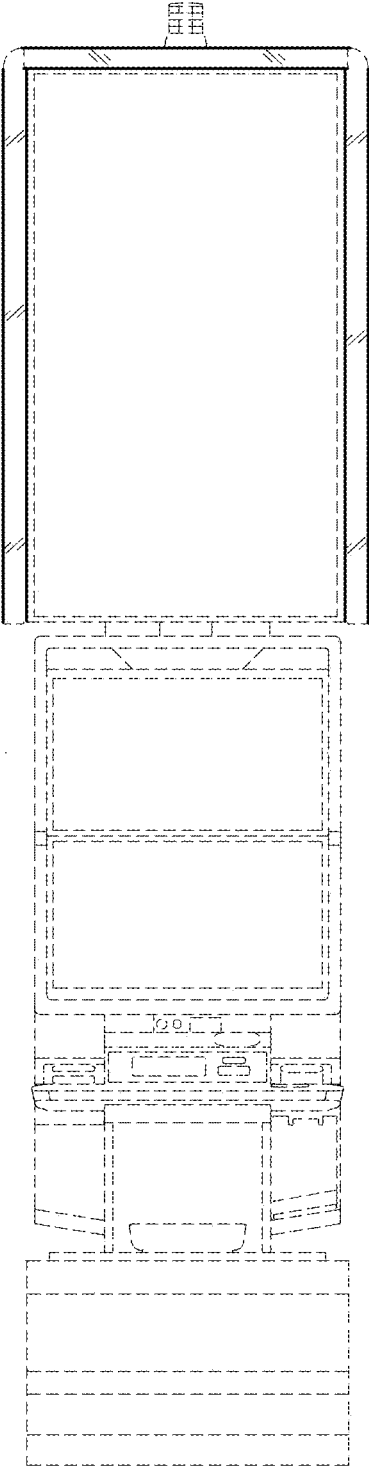

FIG. 2

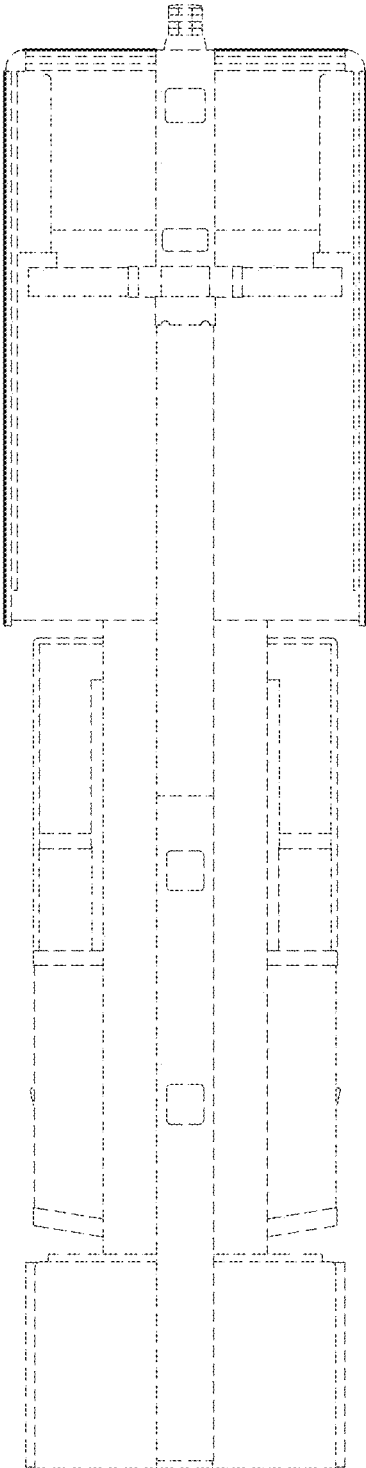

FIG. 3

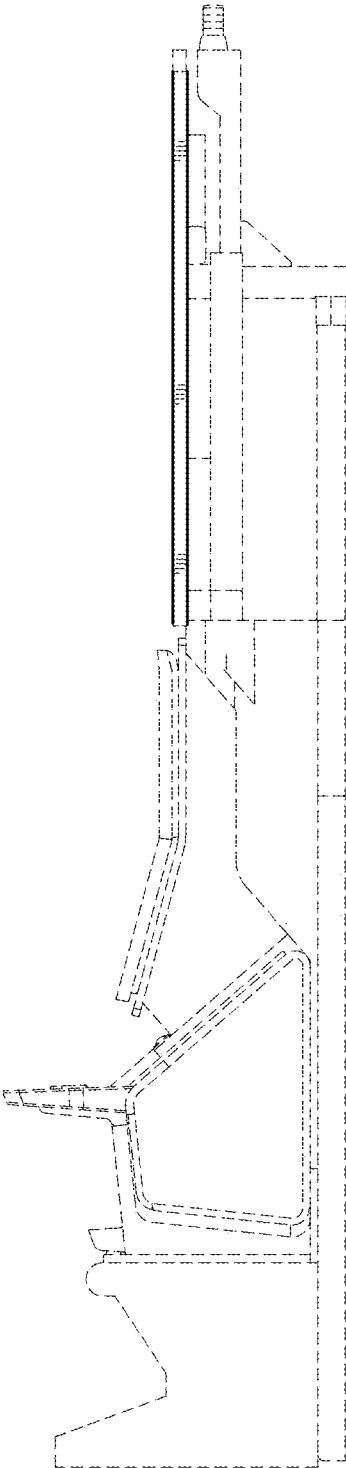

FIG. 4



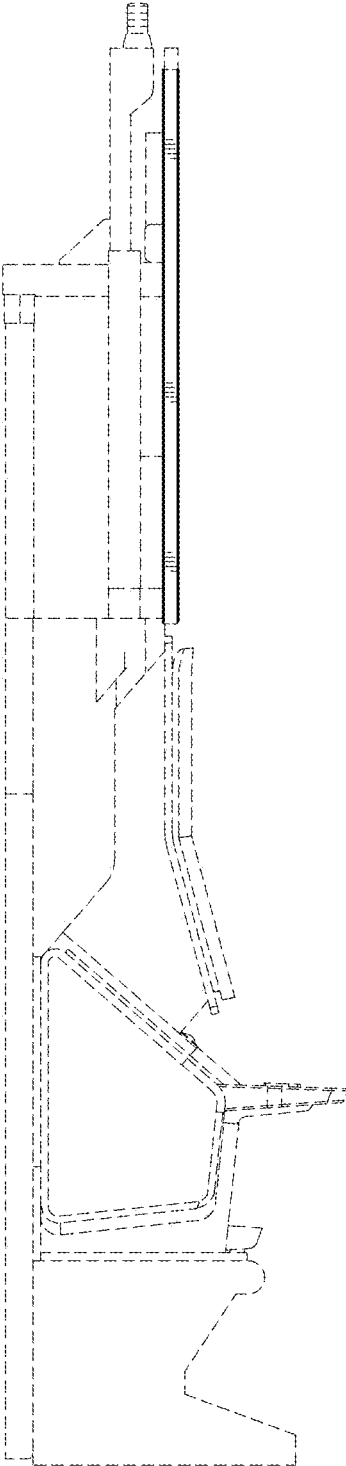

FIG. 5

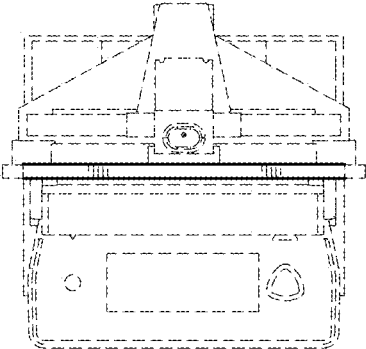

FIG. 6

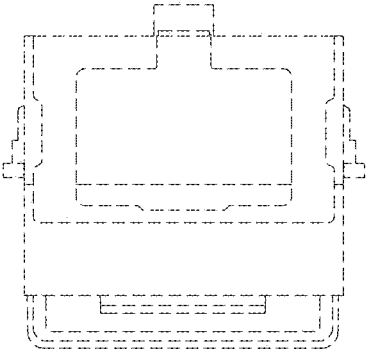

FIG. 7

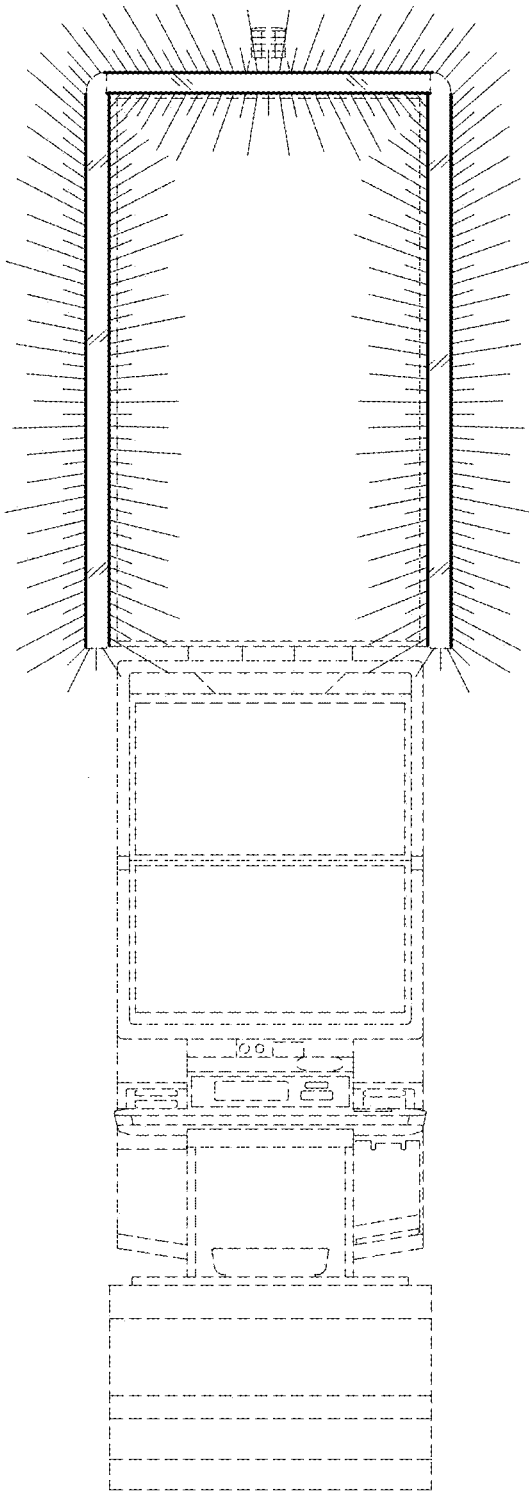

FIG. 8