



US00D712484S

(12) **United States Design Patent**  
**Sumii et al.**

(10) **Patent No.:** **US D712,484 S**

(45) **Date of Patent:** **\*\* Sep. 2, 2014**

(54) **HOUSING OF CONTROLLER FOR ELECTRONIC DEVICE**

(71) Applicant: **Sony Computer Entertainment Inc.,**  
Tokyo (JP)

(72) Inventors: **Tetsu Sumii, Tokyo (JP); Ennin Huang,**  
Tokyo (JP)

(73) Assignee: **Sony Computer Entertainment Inc.,**  
Tokyo (JP)

(\*\*) Term: **14 Years**

(21) Appl. No.: **29/460,699**

(22) Filed: **Jul. 12, 2013**

(30) **Foreign Application Priority Data**

Feb. 19, 2013 (JP) ..... D2013-003276

(51) **LOC (10) Cl.** ..... **21-01**

(52) **U.S. Cl.**

USPC ..... **D21/333; D14/401**

(58) **Field of Classification Search**

CPC ..... A63F 13/02; A63F 11/00; A63F 13/00;  
A63F 3/00; A63F 9/00; A63F 13/08; G06F  
17/00; G06F 19/00; G06F 17/32; G06F 3/00  
USPC ..... D14/399-401, 412-416; D21/324, 333;  
273/148 B; 463/1, 29-39, 46, 47;  
345/156-161, 905

See application file for complete search history.

(56) **References Cited**

**U.S. PATENT DOCUMENTS**

5,551,693 A 9/1996 Goto et al.  
D382,603 S 8/1997 Goto  
D393,885 S 4/1998 Goto  
D397,164 S 8/1998 Goto  
D398,032 S 9/1998 Goto  
D402,317 S 12/1998 Goto

D405,835 S 2/1999 Goto  
D416,588 S 11/1999 Goto  
D430,222 S 8/2000 Goto  
D430,223 S 8/2000 Goto  
D431,051 S 9/2000 Goto  
D439,580 S 3/2001 Goto  
D441,369 S 5/2001 Goto  
D442,180 S 5/2001 Goto  
D443,617 S 6/2001 Goto  
D443,618 S 6/2001 Goto  
D443,877 S 6/2001 Goto  
D444,469 S 7/2001 Goto  
D444,470 S 7/2001 Goto  
6,342,009 B1 \* 1/2002 Soma ..... 463/38  
6,743,100 B1 \* 6/2004 Neiser ..... 463/37  
6,923,443 B1 \* 8/2005 Hughes, IV ..... 273/148 B  
D521,567 S \* 5/2006 Svendsen et al. .... D21/333

(Continued)

*Primary Examiner* — Prabhakar Deshmukh

(74) *Attorney, Agent, or Firm* — Rader, Fishman & Grauer  
PLLC

(57) **CLAIM**

The ornamental design for a housing of controller for elec-  
tronic device, as shown and described.

**DESCRIPTION**

FIG. 1 is a front, top, right perspective view of the housing of controller for electronic device showing our new design; FIG. 2 is a front, bottom, right perspective view thereof; FIG. 3 is a rear, top, left perspective view thereof; FIG. 4 is a front elevational view thereof; FIG. 5 is a rear elevational view thereof; FIG. 6 is a left side elevational view thereof; FIG. 7 is a right side elevational view thereof; FIG. 8 is a top plan view thereof, and, FIG. 9 is a bottom plan view thereof.

The broken lines indicate the unclaimed portions of the controller for electronic device and form no part of the claimed design.

**1 Claim, 5 Drawing Sheets**

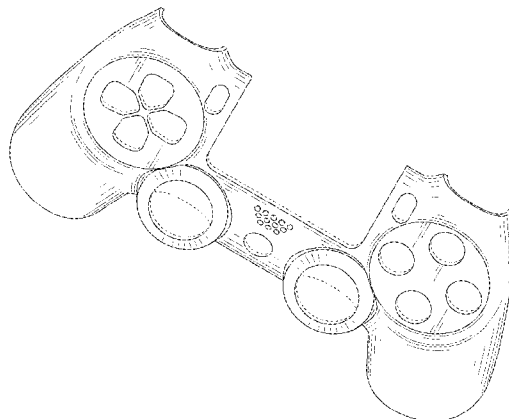

(56)

**References Cited**

U.S. PATENT DOCUMENTS

7,063,321	B2 *	6/2006	Hussaini et al. ....	273/148 B	7,837,559	B2 *	11/2010	Kidakarn .....	463/37
D561,190	S	2/2008	Goto		D638,017	S *	5/2011	Ortiz .....	D14/401
D587,717	S *	3/2009	Harris .....	D14/454	D640,697	S *	6/2011	Lovoi et al. ....	D14/401
7,762,553	B2 *	7/2010	Harris .....	273/148 B	D666,250	S *	8/2012	Fulghum et al. ....	D21/333
					D669,078	S *	10/2012	Lovoi et al. ....	D14/401

\* cited by examiner

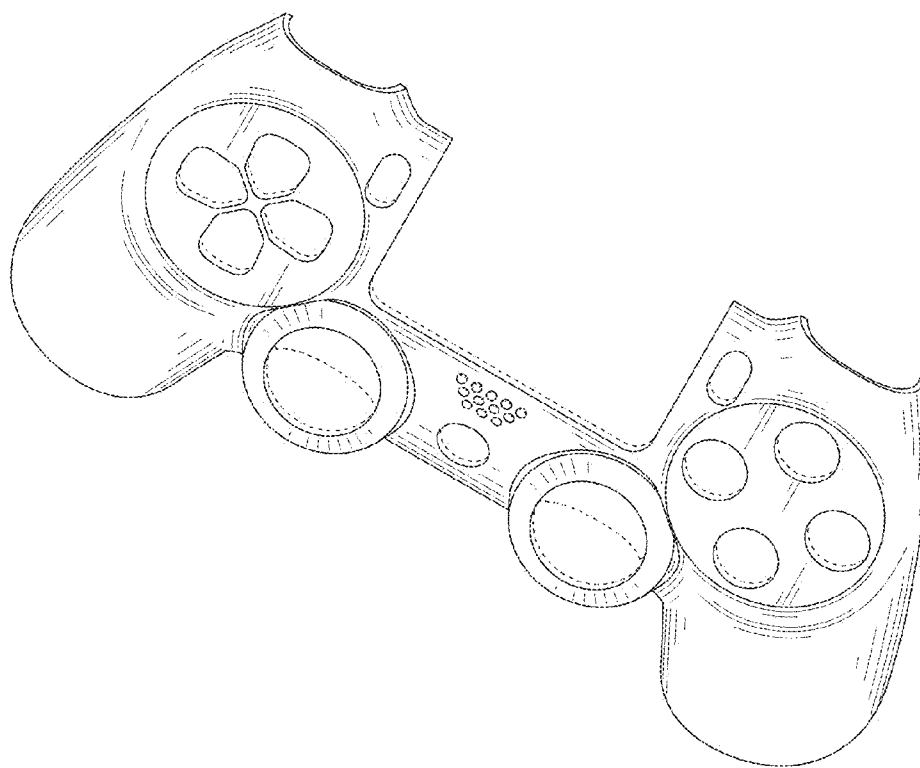

FIG. 1

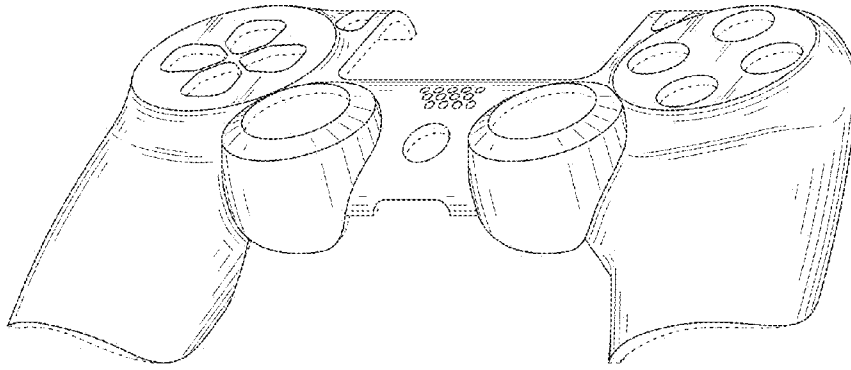

FIG. 2

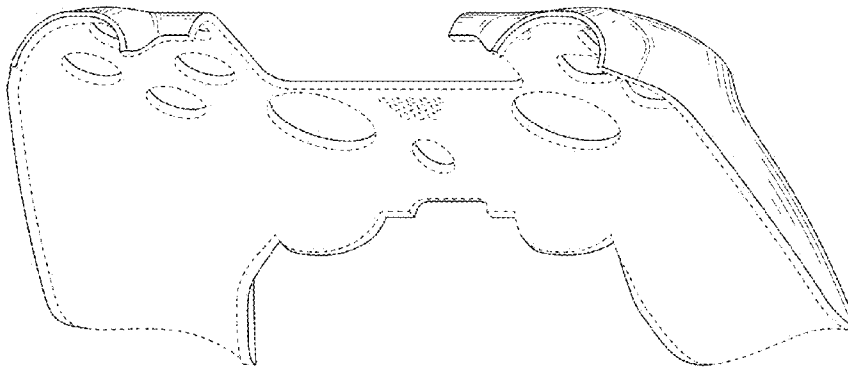

FIG. 3

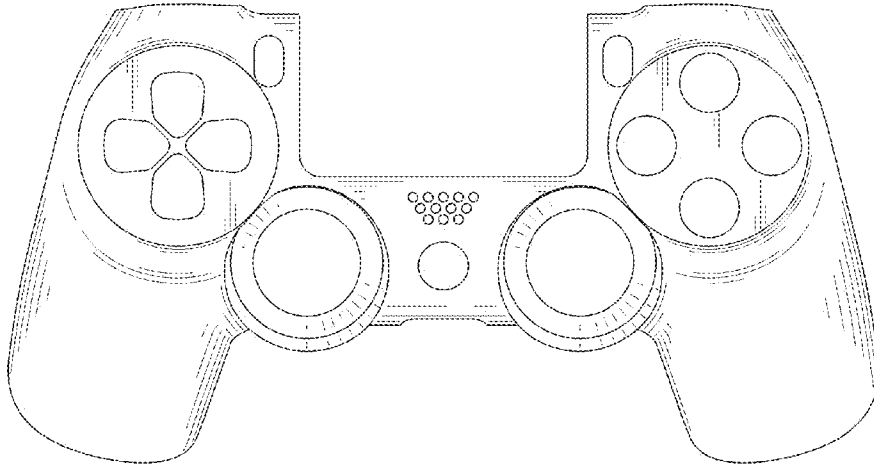

FIG. 4

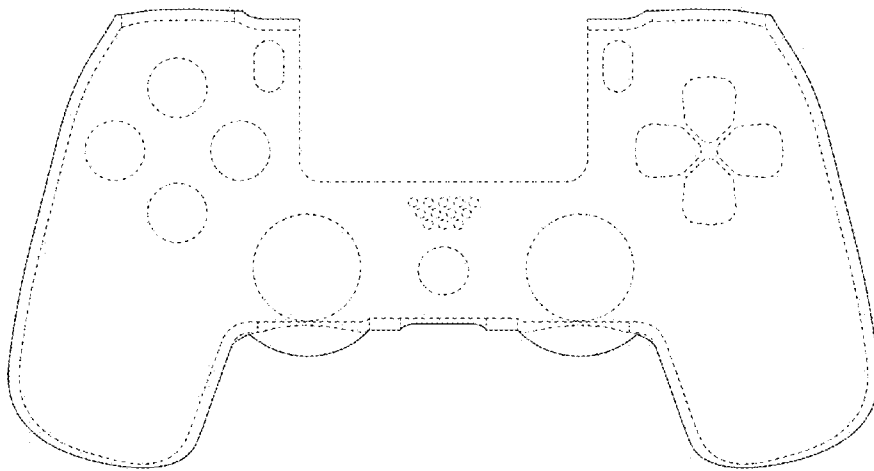

FIG. 5

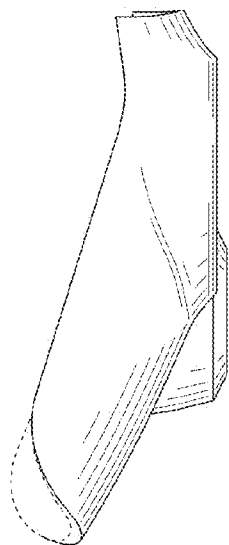

FIG. 6

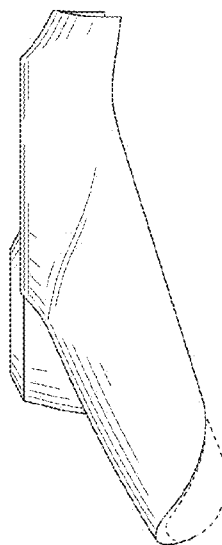

FIG. 7

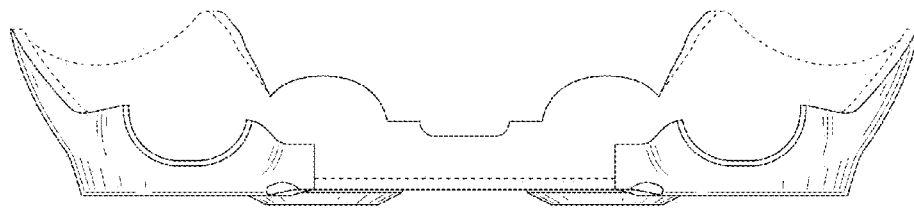

FIG. 8

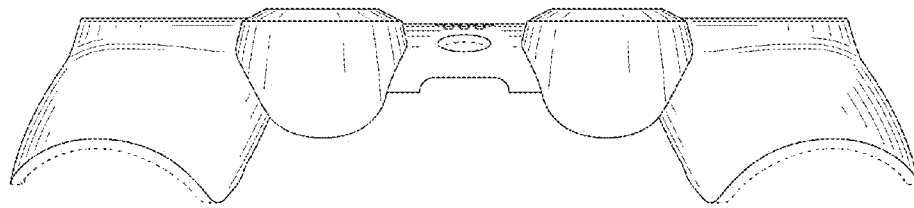

FIG. 9