



US00D598654S

(12) **United States Design Patent**
Huang

(10) **Patent No.:** **US D598,654 S**

(45) **Date of Patent:** **** Aug. 25, 2009**

(54) **TOOTHBRUSH**

(75) Inventor: **Shou-Jen Huang**, Sanchung (TW)

(73) Assignee: **Acumen Co., Ltd.**, Sanchung, Taipei Hsien (TW)

(**) Term: **14 Years**

(21) Appl. No.: **29/332,584**

(22) Filed: **Feb. 20, 2009**

(51) **LOC (9) Cl.** **04-02**

(52) **U.S. Cl.** **D4/108**

(58) **Field of Classification Search** D4/104-112,
D4/134, 138; 15/110, 143.1, 167.1, 167.2;
132/308-311; 601/139, 141; 606/161
See application file for complete search history.

(56) **References Cited**

U.S. PATENT DOCUMENTS

- 2006/0010628 A1* 1/2006 Moskovich 15/111
- 2006/0064833 A1* 3/2006 Jacobs 15/110
- 2007/0283518 A1* 12/2007 Blanchard et al. 15/167.1
- 2008/0131834 A1* 6/2008 Shepherd et al. 433/29

FOREIGN PATENT DOCUMENTS

KR 30-0436408 S * 1/2007

OTHER PUBLICATIONS

EM 65677-0003 Industrial Design Application, (M + C Shiffer GmbH) Jan. 27, 2004, [online], [retrieved on Apr. 18, 2008]

Retrieved from the OAMI Database of the Office for Harmonization in the Internal Market using the Internet <URL: <http://oami.europa.eu>>.*

HK 0800531.4 Industrial Design Application, (Colgate-Palmolive Company) Apr. 25, 2008, [online], [retrieved on May 24, 2009] Retrieved from the Designs Registry, Intellectual Property Department of the Government of Hong Kong Special Administrative Region using the Internet <URL: <http://ipsearch.ipd.gov.hk>>.*

* cited by examiner

Primary Examiner—Melanie H Tung
Assistant Examiner—Lavone D Tabor
(74) *Attorney, Agent, or Firm*—patenttm.us

(57) **CLAIM**

The ornamental design for a toothbrush, as shown.

DESCRIPTION

FIG. 1 is a perspective view of a toothbrush showing my new design;

FIG. 2 is a front view thereof;

FIG. 3 is an enlarged left view thereof;

FIG. 4 is an enlarged right view thereof;

FIG. 5 is a top view thereof;

FIG. 6 is a bottom view thereof; and,

FIG. 7 is another perspective view thereof.

1 Claim, 5 Drawing Sheets

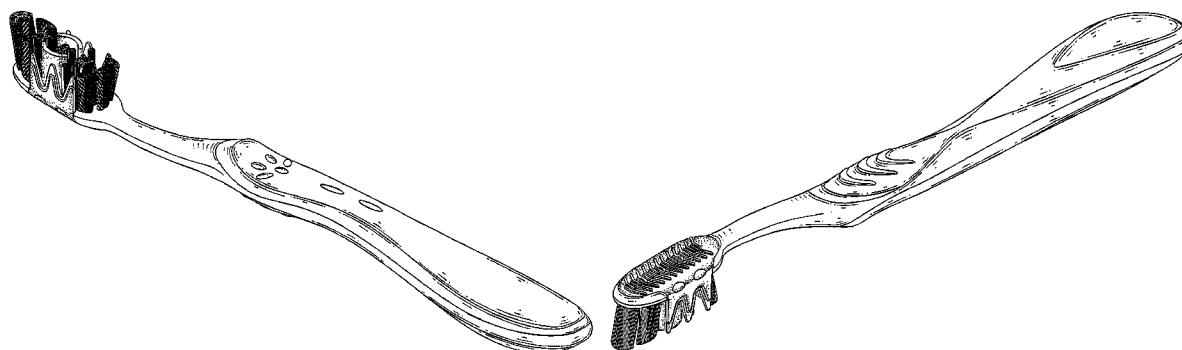

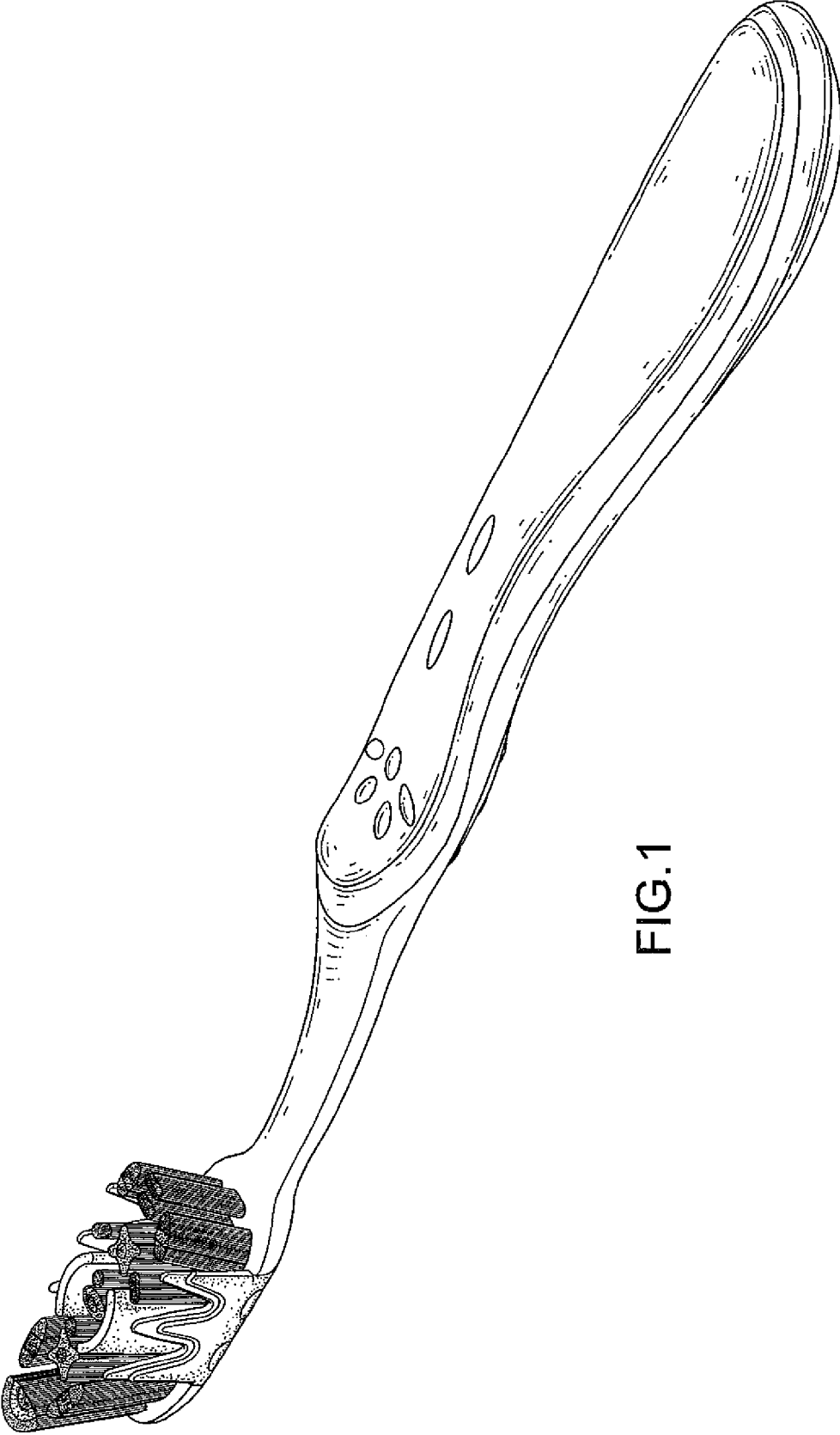

FIG.1

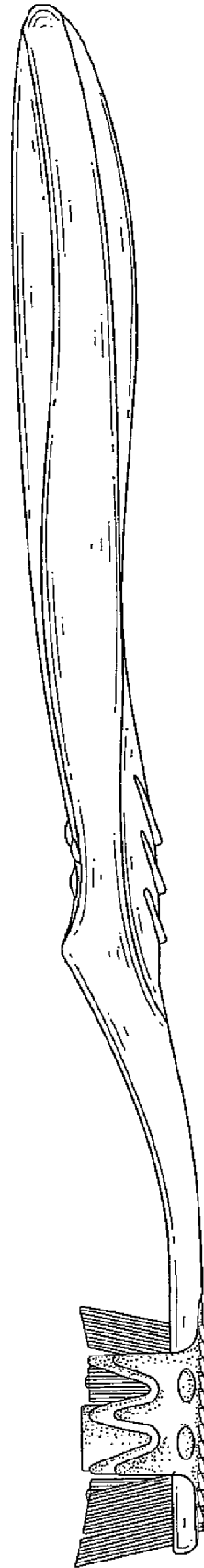

FIG.2

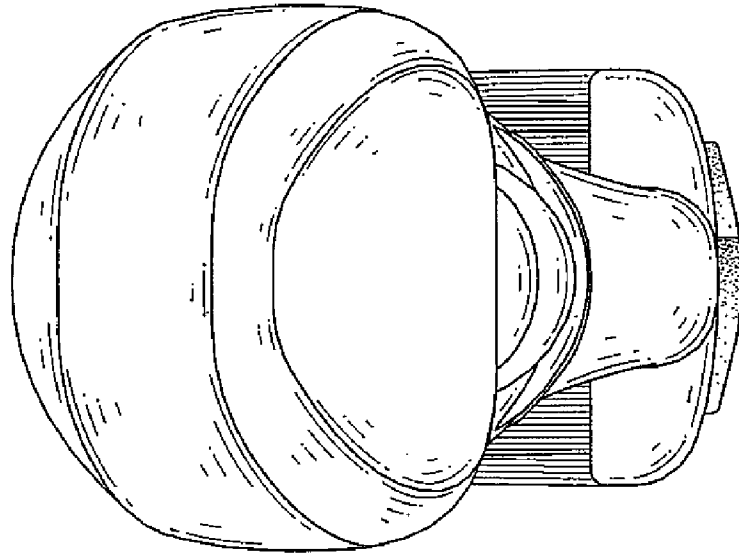

FIG.4

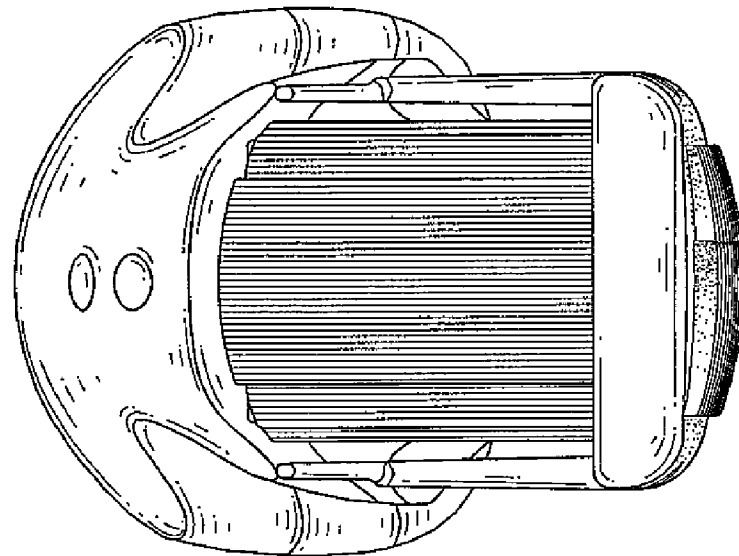

FIG.3

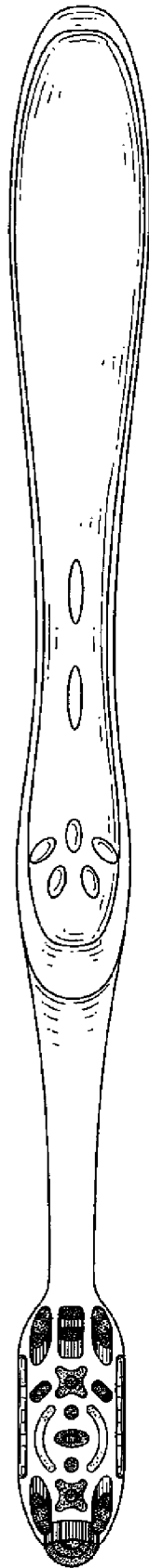

FIG. 5

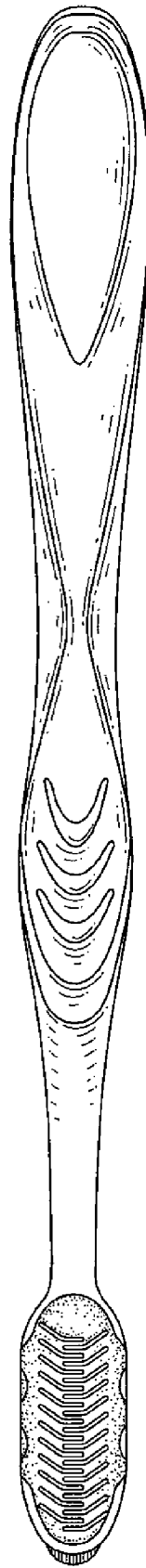

FIG. 6

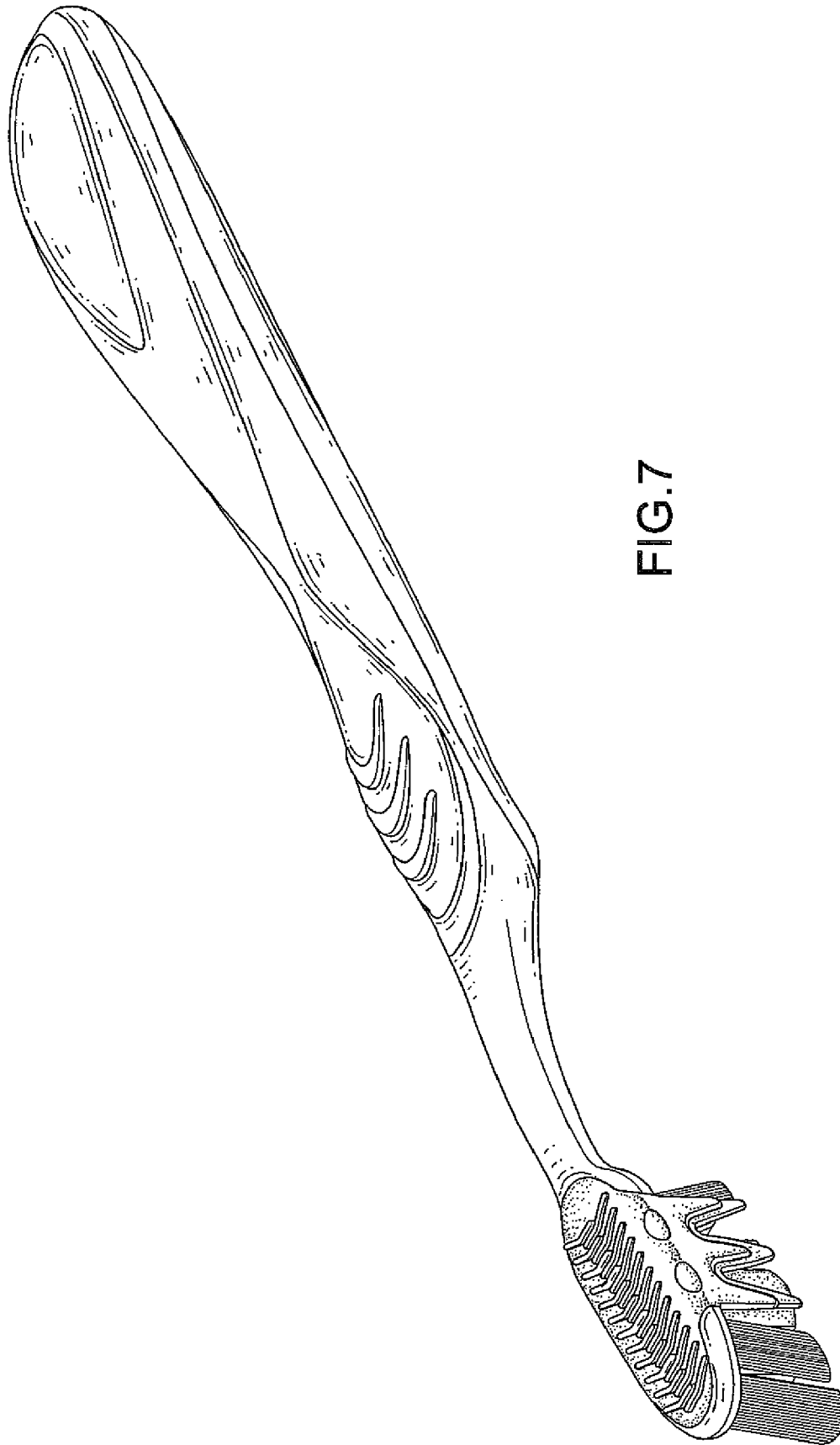

FIG.7