



US00D625472S

(12) **United States Design Patent**
Matz et al.

(10) **Patent No.:** **US D625,472 S**

(45) **Date of Patent:** **** Oct. 12, 2010**

(54) **GROOMING TOOL**

(75) Inventors: **Andrea Matz**, Stanhope, NJ (US); **Ryan Rutherford**, Belleville, NJ (US); **Jonathan Willinger**, Tenefly, NJ (US)

(73) Assignee: **J.W. Pet Company, Inc.**, Teterboro, NJ (US)

(**) Term: **14 Years**

(21) Appl. No.: **29/358,392**

(22) Filed: **Mar. 26, 2010**

Related U.S. Application Data

(62) Division of application No. 29/333,964, filed on Mar. 18, 2009, now Pat. No. Des. 615,714.

(51) **LOC (9) Cl.** **30-99**

(52) **U.S. Cl.** **D30/158**

(58) **Field of Classification Search** D30/158-159, D30/199; 119/600, 601, 604-606, 611-619, 119/625, 628-633, 624; D4/132-138, 100-102, D4/122, 127, 119, 114, 199, 118, 121, 159, D4/129, 130, 116, 18, 117, 120; D8/106, D8/107, 13, 45, 80; 401/28, 201, 6, 284, 401/279, 288, 22, 140, 207, 149, 281, 136, 401/137, 188 R, 189, 190, 268, 270, 278; 132/119-121, 152, 154, 147-150, 108-110, 132/112-115, 160; D28/31, 63, 30, 25, 21, D28/7, 34; 15/50.1-50.3, 55, 57, 71, 77, 15/79.1, 104.002, 105-106, 143.1, 159.1, 15/160, 186-188, 169, 145, 114, 231, 172, 15/1.52, 207.2, 29, 229.13, 111, 118, 109.94, 15/164, 209.1, 211, 236.06, 236.01, 236.05, 15/210.1, 229.11, 244.3, 191.1; 56/400.01, 56/400.17, 400.21; 81/177.7, 489, 177.1, 81/436-440, 849; 16/426, 421, 422, 438, 16/110.1, 430, DIG. 12, DIG. 19; 30/353; 19/98; 294/104, 19.1, 3; 601/138, 114, 17, 601/160, 112, 154, 137; 604/289; D24/215, D24/214, 206; D32/40, 42, 45, 35, 41

See application file for complete search history.

(56) **References Cited**

U.S. PATENT DOCUMENTS

238,297 A	3/1881	Lawrence	
D20,486 S	1/1891	Thompson	
487,580 A	12/1892	Neuls	
1,852,362 A	4/1932	Newby	
2,150,260 A	3/1939	Berry	
D114,197 S	4/1939	Muller-Munk	
D142,930 S *	11/1945	Adler	D28/31
D152,375 S *	1/1949	Seley	D32/41
2,482,120 A	9/1949	Mishkinis	

(Continued)

OTHER PUBLICATIONS

UPCO Catalogue Fall 2005, p. 36 "Undercoat Rakes". 1 page.*

(Continued)

Primary Examiner—Susan Moon Lee
(74) *Attorney, Agent, or Firm*—Katten Muchin Rosenman LLP

(57) **CLAIM**

We claim the ornamental design for a grooming tool, as shown and described.

DESCRIPTION

FIG. 1 is a perspective view of a grooming tool;
FIG. 2 is a front view thereof;
FIG. 3 is a rear view thereof;
FIG. 4 is a left side view thereof;
FIG. 5 is a right side view thereof;
FIG. 6 is a top view thereof; and,
FIG. 7 is a bottom view thereof.

The portions shown in broken line are not claimed.

1 Claim, 5 Drawing Sheets

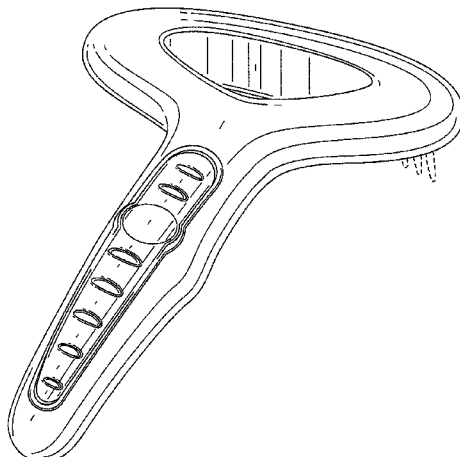

U.S. PATENT DOCUMENTS

D168,915 S *	2/1953	Snyder	D4/136	6,450,127 B2	9/2002	Willinger et al.	
2,630,594 A	3/1953	Fisher		D465,930 S	11/2002	Offer et al.	
2,633,591 A	4/1953	Servilla		D468,109 S	1/2003	Plante et al.	
2,918,686 A	12/1959	Rowland		D473,343 S	4/2003	Carruba et al.	
3,010,131 A	11/1961	Kisky		D473,682 S	4/2003	Plante et al.	
D199,718 S *	12/1964	Adler	D28/31	6,543,388 B2	4/2003	Willinger et al.	
3,421,171 A	1/1969	Teruya		6,543,954 B2	4/2003	Owings	
3,474,481 A	10/1969	Soleymani et al.		D480,215 S	10/2003	Mastroianni	
3,491,777 A	1/1970	Grosbard		6,637,441 B2	10/2003	Kennedy et al.	
D222,792 S	12/1971	Krusche et al.		D484,314 S	12/2003	DiGioia	
D235,170 S	5/1975	McNair		D485,990 S	2/2004	Wallace	
4,098,266 A	7/1978	Muchisky et al.		D491,310 S	6/2004	Glucksman et al.	
4,244,075 A	1/1981	Silver		D492,119 S	6/2004	Hay	
4,417,826 A	11/1983	Floros		D493,569 S	7/2004	Angeletta	
4,508,108 A	4/1985	Miyaoka		D497,450 S	10/2004	Scofield	
4,720,883 A	1/1988	Sanchez		D501,607 S	2/2005	Hay et al.	
4,826,340 A	5/1989	Rothweiler et al.		D502,568 S	3/2005	Longoria	
4,841,590 A	6/1989	Terry et al.		D504,234 S	4/2005	Kuo et al.	
4,927,283 A	5/1990	Fitjer		6,955,137 B2	10/2005	Dunn et al.	
D309,984 S	8/1990	Gingras		D515,737 S	2/2006	Angeletta	
4,974,286 A	12/1990	Stowell et al.		D518,598 S	4/2006	Angeletta	
4,998,836 A	3/1991	Scripnick		D518,916 S	4/2006	Angeletta	
5,067,444 A	11/1991	Parker		D521,242 S	5/2006	Gaiti	
D324,914 S	3/1992	Bucher		D523,173 S	6/2006	Angeletta	
D331,288 S	11/1992	Yuen		D524,545 S	7/2006	Hinnant	
D334,430 S	3/1993	Tsou		D524,547 S	7/2006	Hay	
D335,171 S	4/1993	Lenci et al.		D525,744 S	7/2006	Dibnah et al.	
5,267,528 A *	12/1993	Murieen, Sr.	119/628	D549,411 S	8/2007	McNeeley et al.	
5,305,490 A	4/1994	Lundgren		D565,258 S *	3/2008	Porter et al.	D30/158
5,322,382 A	6/1994	Hull et al.		D565,846 S	4/2008	Holcomb et al.	
5,385,532 A	1/1995	Shyu		D575,528 S	8/2008	Libman et al.	
5,388,700 A	2/1995	Per-Lee		D591,953 S	5/2009	Krus et al.	
5,392,483 A	2/1995	Heinzelman et al.		D610,755 S *	2/2010	Lin	D30/159
5,398,369 A	3/1995	Heinzelman et al.		D610,756 S	2/2010	Lin	
D357,810 S	5/1995	Evans		2001/0011528 A1 *	8/2001	Willinger et al.	119/633
5,421,765 A	6/1995	Lehmann et al.		2001/0034920 A1	11/2001	Brown	
5,435,039 A	7/1995	Taylor		2002/0040686 A1	4/2002	Willinger et al.	
5,454,659 A	10/1995	Vosbikian et al.		2004/0265042 A1	12/2004	Chan et al.	
5,465,449 A	11/1995	Lewkowicz		2005/0092340 A1	5/2005	Rijskamp	
D367,176 S	2/1996	Berti		2005/0241594 A1	11/2005	Willinger et al.	
5,503,109 A	4/1996	Sporn		2006/0010625 A1	1/2006	Tapper et al.	
D369,882 S	5/1996	McCarthy		2008/0078333 A1	4/2008	Wang	
D371,219 S	6/1996	Bouchez					
D373,904 S	9/1996	Vanderhoef et al.					
D381,771 S	7/1997	Chern					
5,673,455 A	10/1997	Per-Lee et al.					
D388,535 S	12/1997	Per-Lee					
5,819,758 A	10/1998	Sohler					
5,823,145 A	10/1998	Hingiss					
5,864,915 A	2/1999	Ra					
D410,789 S	6/1999	Cheng					
D424,747 S	5/2000	Chen					
D426,916 S	6/2000	Ebert					
D426,924 S *	6/2000	Joiner et al.	D32/35				
D437,487 S	2/2001	Chen					
D437,690 S	2/2001	Stevenson et al.					
6,213,055 B1	4/2001	Willinger et al.					
6,250,833 B1	6/2001	Perry et al.					
D444,925 S	7/2001	Monette					
6,279,582 B1 *	8/2001	Wang	132/154				
D448,114 S	9/2001	Faust et al.					
D452,044 S	12/2001	Goetschi					
D453,420 S	2/2002	Offer et al.					
6,425,701 B1	7/2002	Jacobs					
D461,279 S	8/2002	Angeletta					

OTHER PUBLICATIONS

Non-final Office Action dated Apr. 25, 2000 from corresponding U.S. Appl. No. 09/218,252.
 Non-final Office Action dated Sep. 26, 2000 from corresponding U.S. Appl. No. 09/218,252.
 Non-final Office Action dated Jun. 28, 2001 from corresponding U.S. Appl. No. 09/829,261.
 Non-final Office Action dated Jun. 4, 2002 from corresponding U.S. Appl. No. 10/017,514.
 (1) Jeffers Pet Catalogue, Jun. 2005, p. 85 (1 page). (2) Jeffers Pet Catalogue, Jun. 2007, pp. 92, 93, 131 (3 pages).
 (1) Drs. Foster and Smith catalogue, 2002 issue, p. 105 (1 page). (2) Drs Foster and Smith catalogue, Dec. 2005 issue, p. 132 (1 page). (3) Drs. Foster and Smith catalogue, Jul. 2005, p. 102 (1 page).
 (1) Care-a-Lot Pet catalogue, 2002 issue, p. 62 (1 page). (2) Care-a-Lot Pet catalogue, Oct. 2003 issue, p. 62 (1 page).
 UPCO Catalogue, Fall 2005, pp. 34, 37 (2 pages).
 J.B. Wholesale Pet Catalogue, Nov. 2006, p. 81 (1 page).
 Cherrybrook Catalogue, Nov 2006, p. 83 (1page).
 Pet Solutions Catalogue, Sep. 2009, p. 31 (1page).
 Non-Final Office Action dated Oct. 1, 2009 from corresponding U.S. Appl. No. 29/333,964.

* cited by examiner

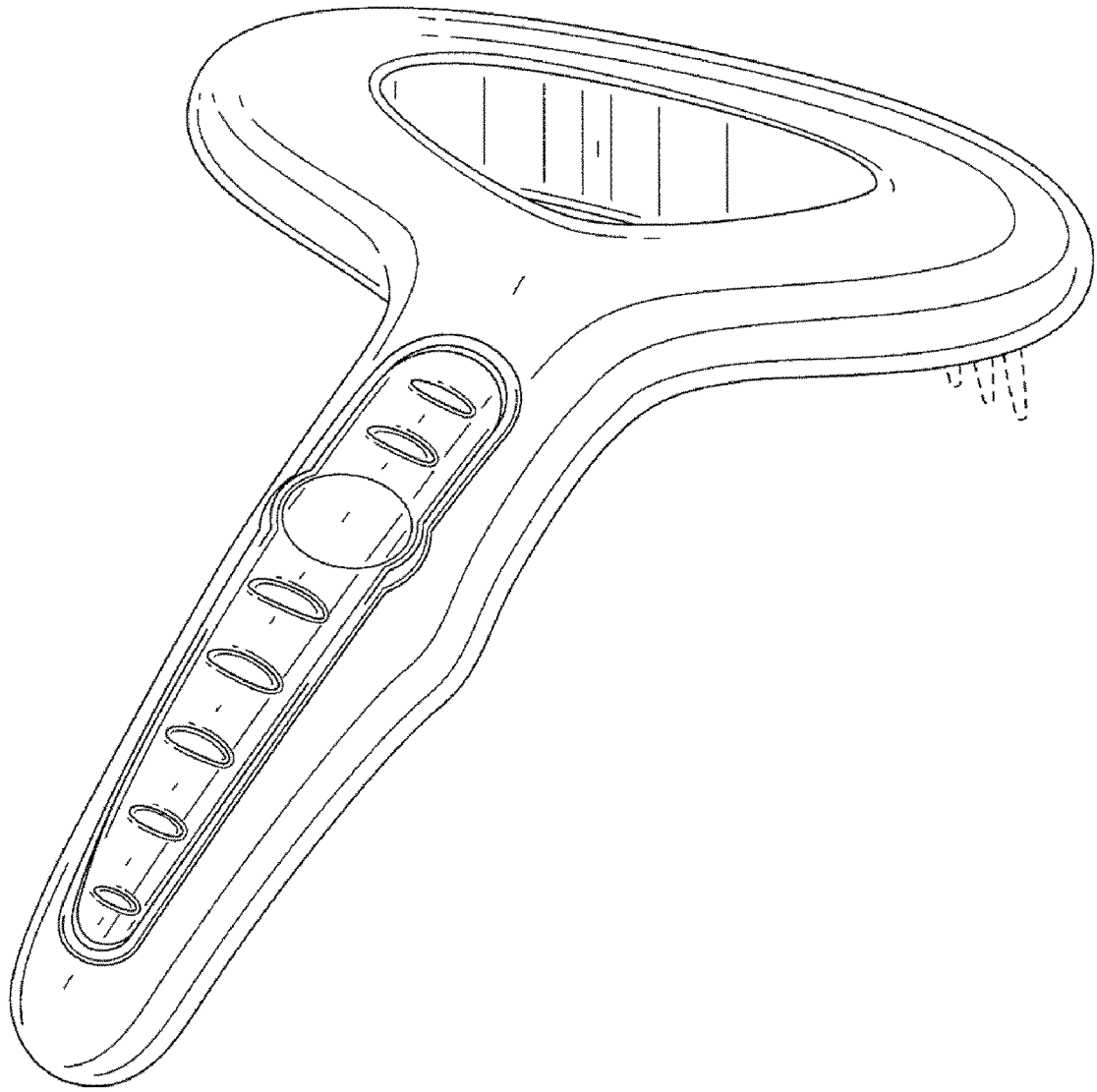

FIG. 1

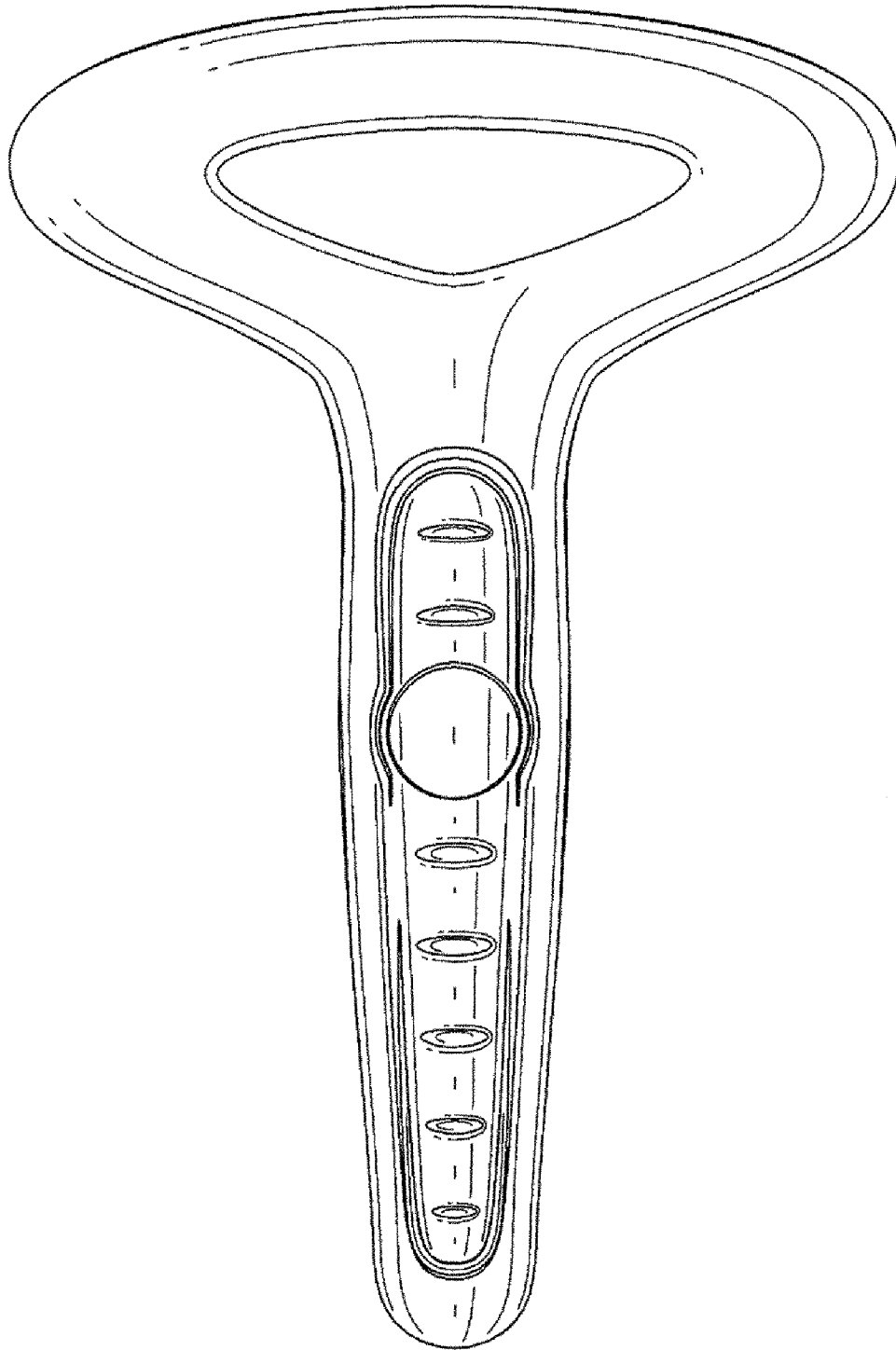

FIG. 2

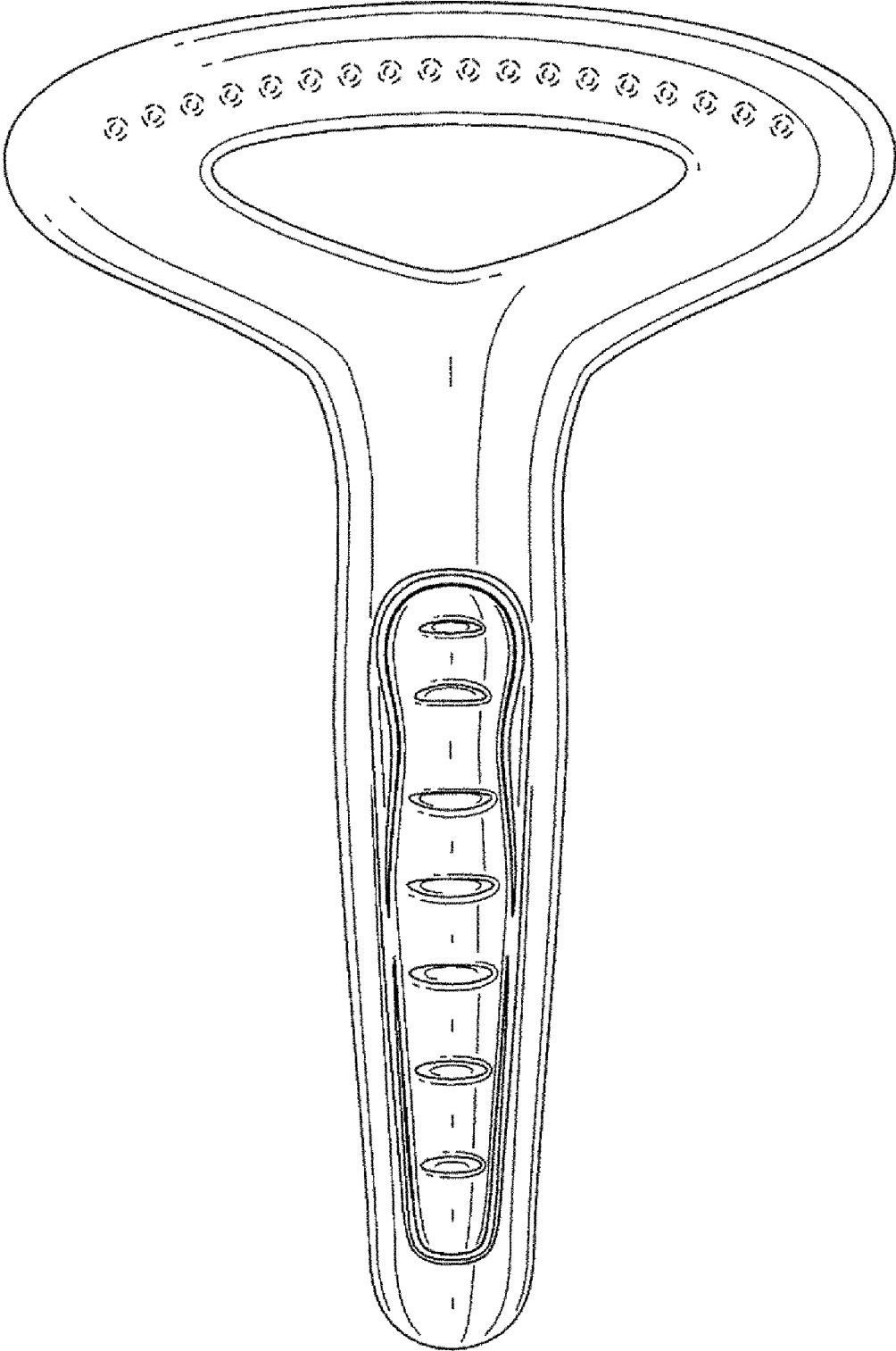

FIG. 3

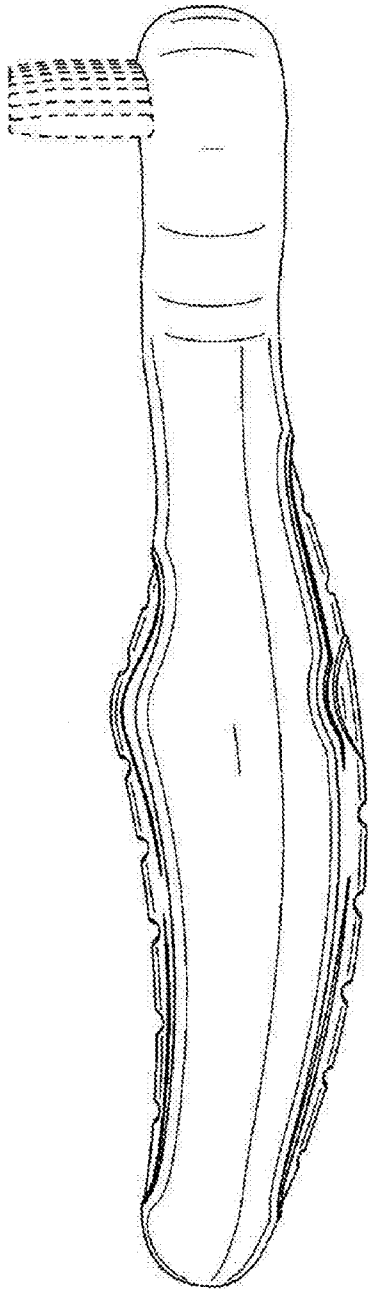

FIG. 4

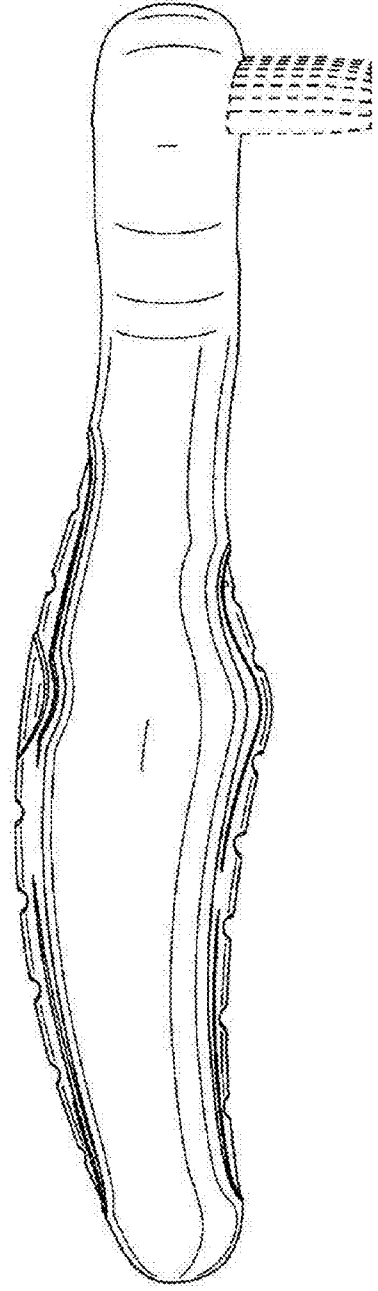

FIG. 5

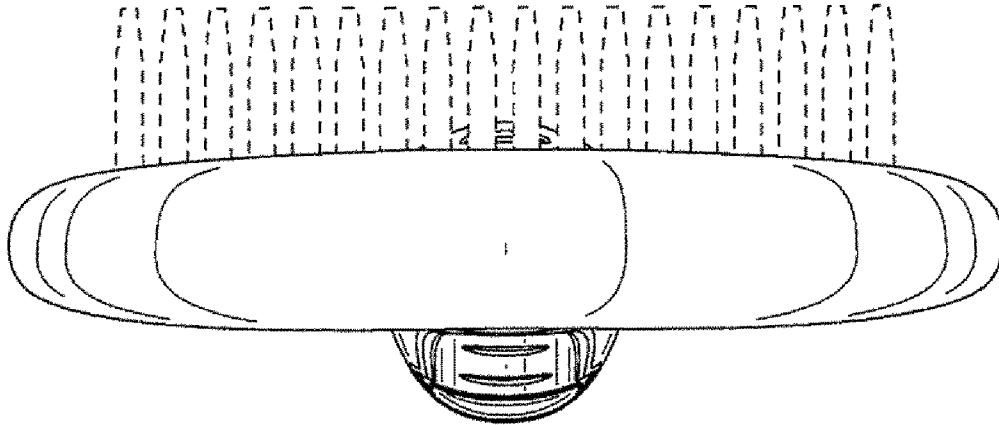

FIG. 6

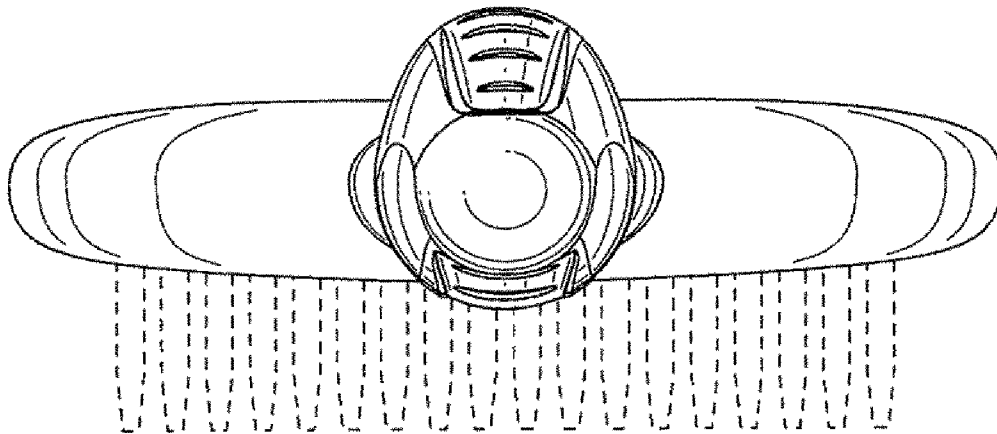

FIG. 7