



US00D463194S

(12) **United States Design Patent** (10) **Patent No.:** **US D463,194 S**  
**Busick et al.** (45) **Date of Patent:** **\*\* Sep. 24, 2002**

(54) **BEVERAGE COOLER**  
(75) Inventors: **Louis M. Busick**, Columbus, OH (US);  
**Stephen W. Wharton**, Columbus, OH (US); **Stephen J. Sabin**, Ballina (IE);  
**Declan L. Coyle**, Ballina (IE)  
(73) Assignee: **Oasis Corporation**, Columbus, OH (US)

5,513,495 A 5/1996 West et al.  
5,560,211 A 10/1996 Parker  
6,003,318 A 12/1999 Busick et al.  
D419,362 S \* 1/2000 Bouhuys ..... D7/306  
D431,145 S \* 9/2000 Woebecke et al. .... D7/306  
D435,994 S \* 1/2001 Gaffney ..... D7/306  
D442,009 S \* 5/2001 Schwarzli ..... D7/306  
D443,792 S \* 6/2001 Peters et al. .... D7/306

(\*\*) Term: **14 Years**

\* cited by examiner

(21) Appl. No.: **29/148,779**

*Primary Examiner*—M. N. Pandozzi  
(74) *Attorney, Agent, or Firm*—Kelly Bauersfeld Lowry & Kelley, LLP

(22) Filed: **Sep. 26, 2001**

(57) **CLAIM**

(51) **LOC (7) Cl.** ..... **07-01**  
(52) **U.S. Cl.** ..... **D7/313; D7/306**  
(58) **Field of Search** ..... D7/300, 306, 312,  
D7/313, 307, 308; 137/371; 222/183, 185.1,  
146.6, 146.1; 194/317; 210/466, 232; 62/3.64,  
389, 3.63

The ornamental design for a beverage cooler, substantially as shown.

**DESCRIPTION**

(56) **References Cited**

**U.S. PATENT DOCUMENTS**

D161,592 S \* 1/1951 Persak, Jr. .... D7/313  
D164,941 S \* 10/1951 Nevell ..... D7/313  
D199,408 S \* 10/1964 Felske ..... D7/313  
3,289,895 A \* 12/1966 Yuza ..... 222/146.1  
4,145,291 A \* 3/1979 Console et al. .... 210/466  
4,993,229 A \* 2/1991 Baus et al. .... 62/3.64  
D358,289 S \* 5/1995 Thies et al. .... D7/306  
5,501,077 A 3/1996 Davis et al.

FIG. 1 is a perspective view showing the front, top and right sides of a beverage cooler embodying our new design; FIG. 2 is a front elevation view thereof; FIG. 3 is a right side elevation view thereof, the left side elevation being a mirror image of the right side elevation as shown; FIG. 4 is a rear elevation view thereof; FIG. 5 is a top plan view thereof; FIG. 6 is a bottom plan view thereof; and, FIG. 7 is a perspective view showing the rear, top and left sides thereof.

**1 Claim, 6 Drawing Sheets**

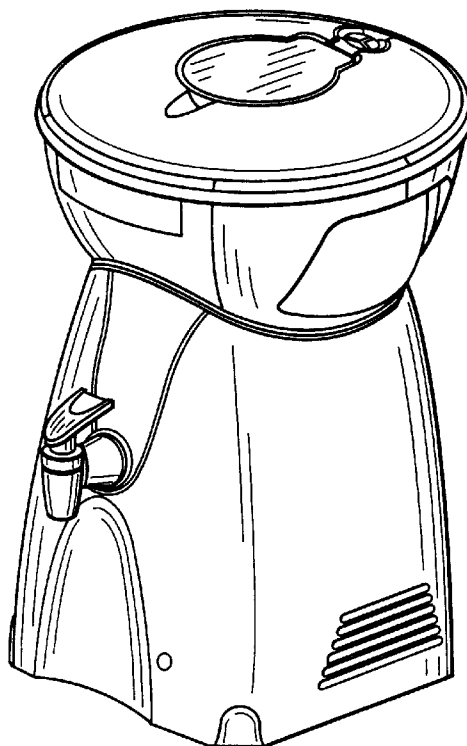

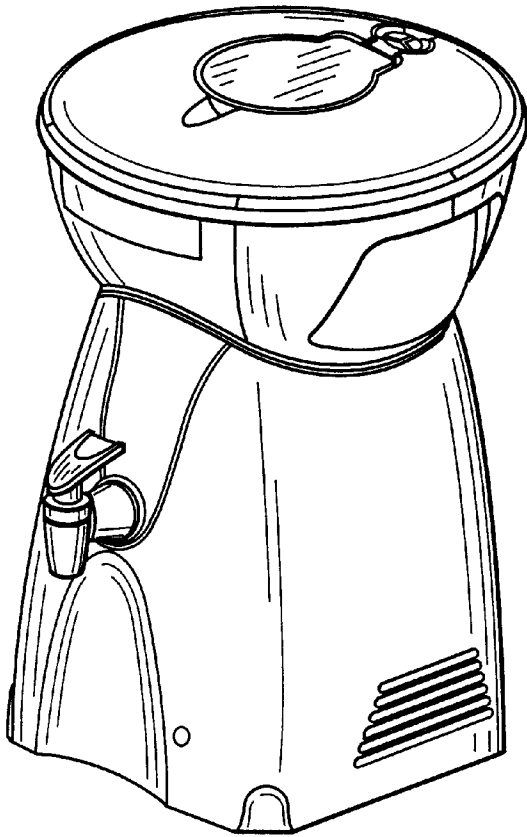

FIG. 1

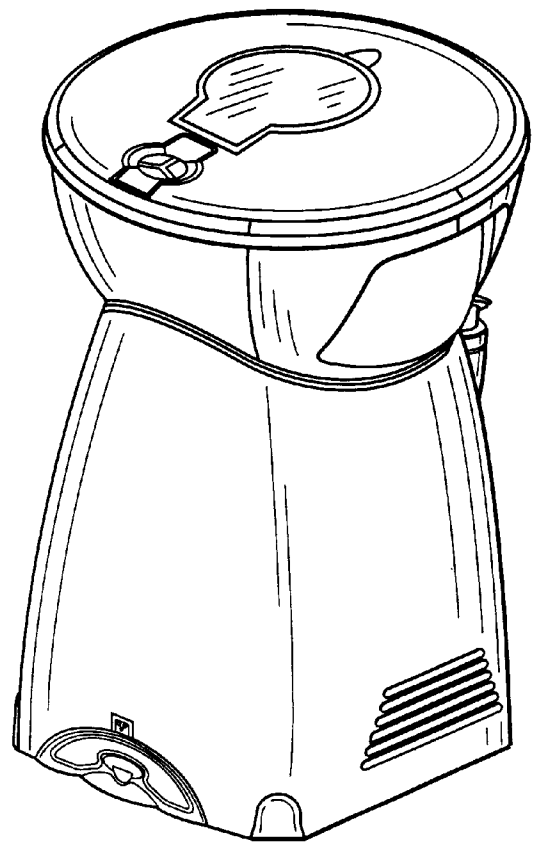

FIG. 7

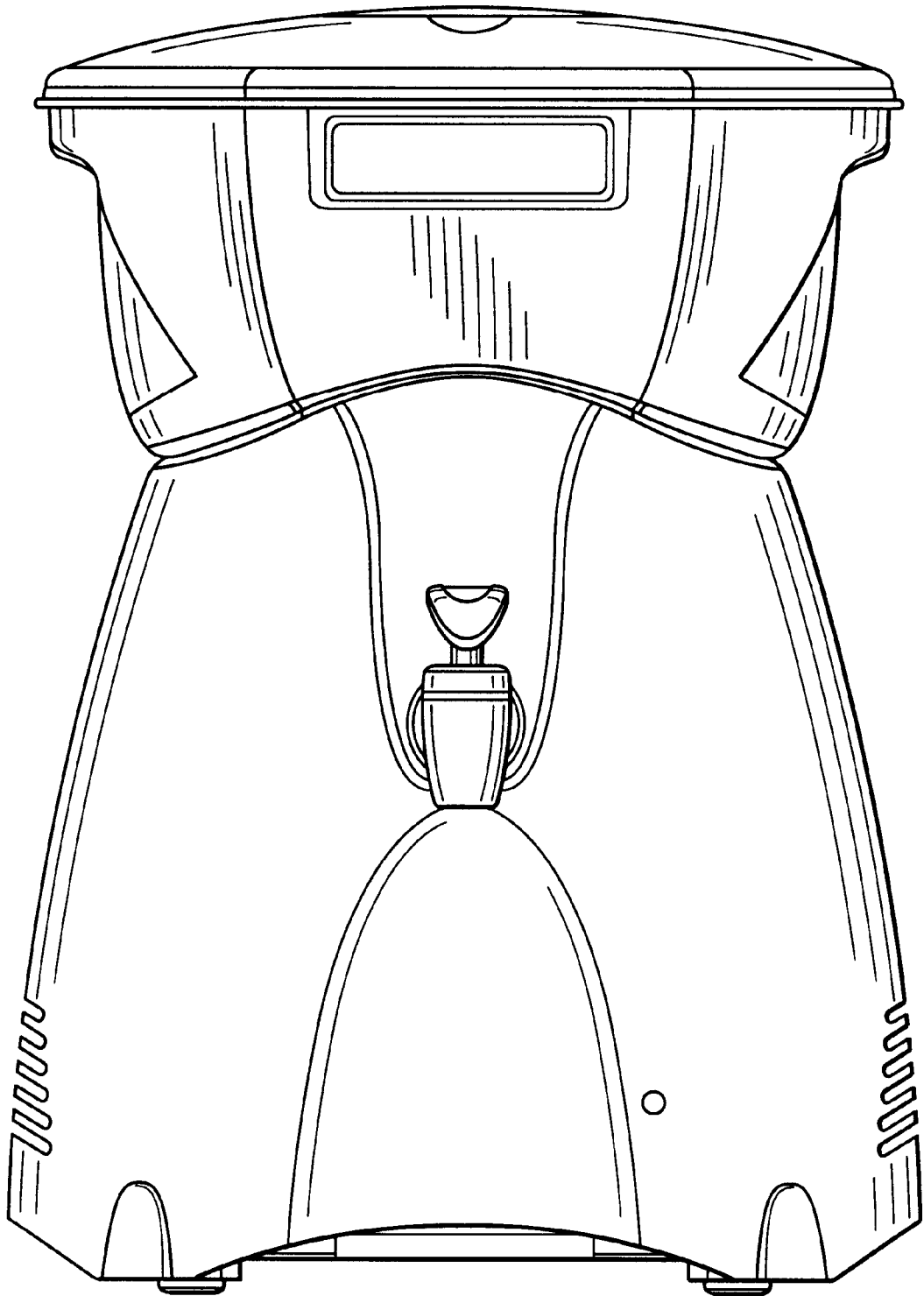

FIG. 2

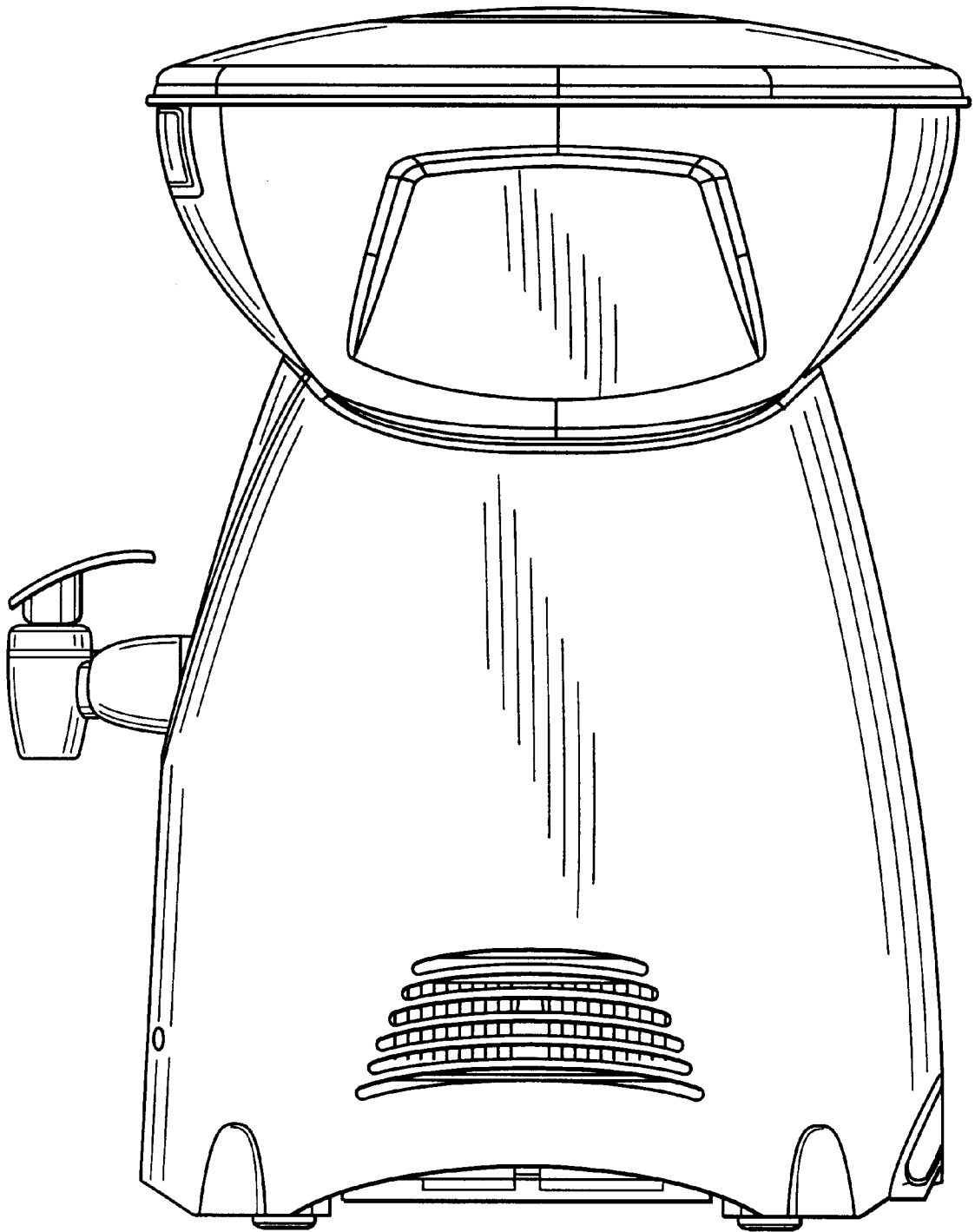

FIG. 3

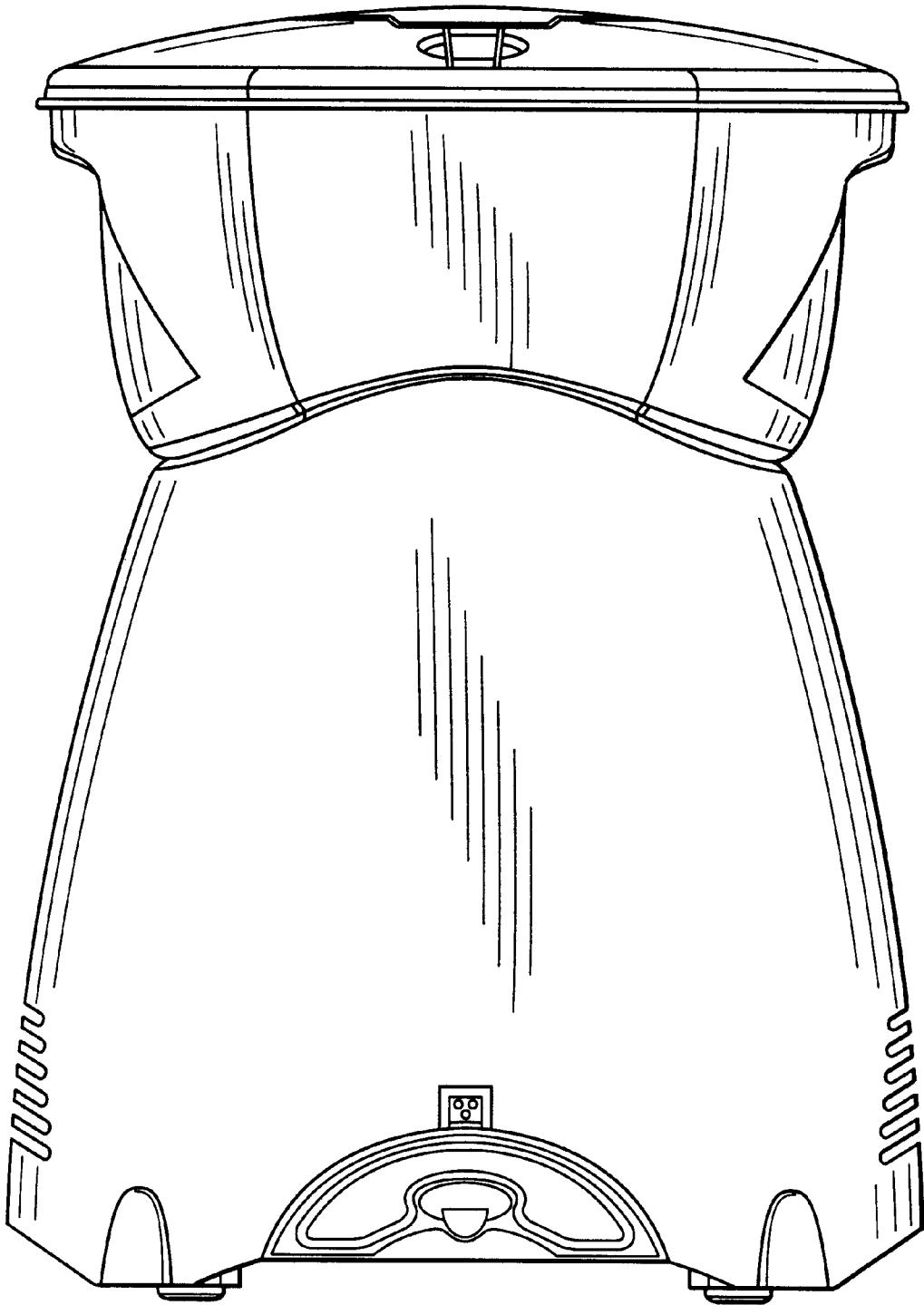

FIG. 4

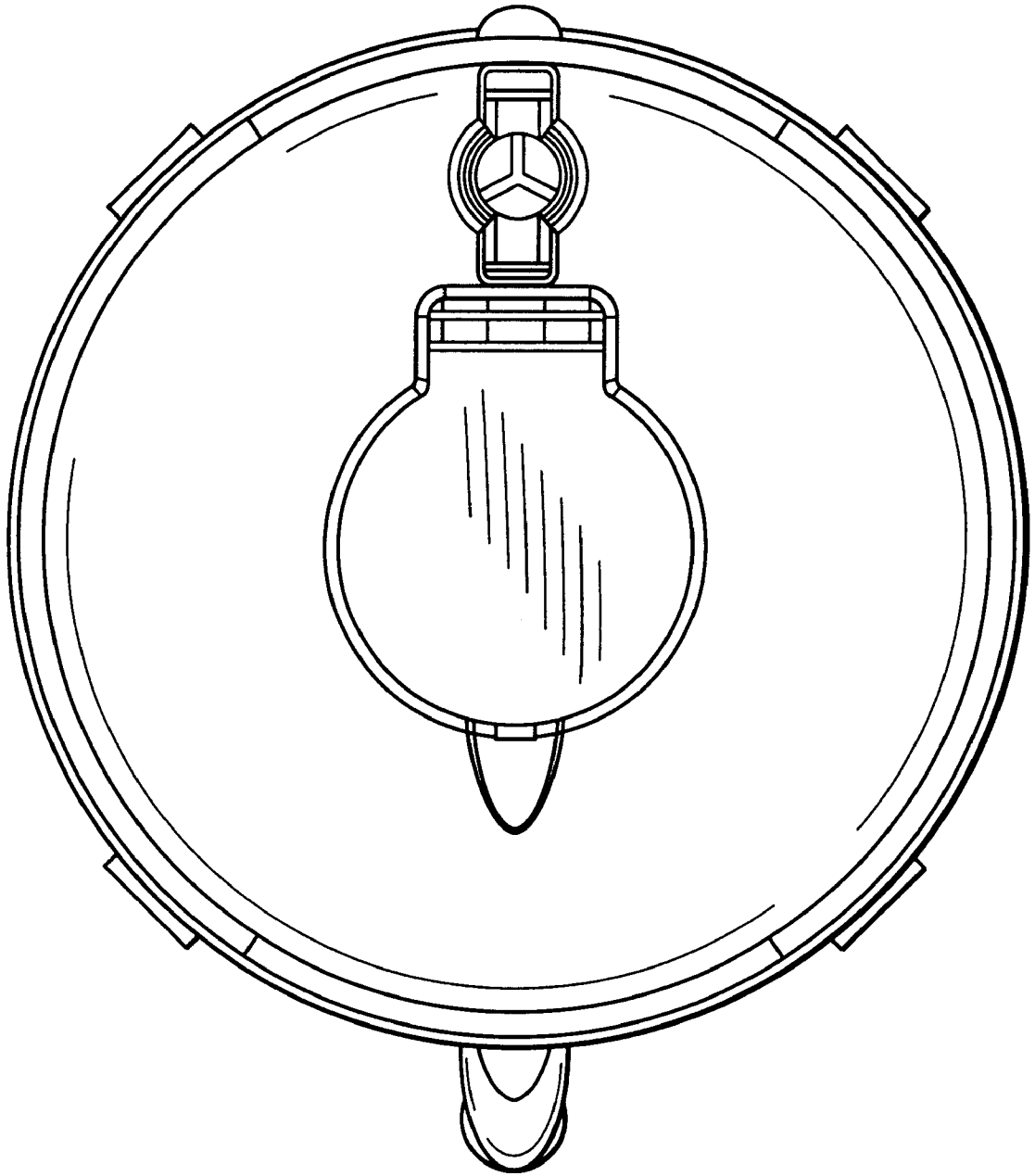

FIG. 5

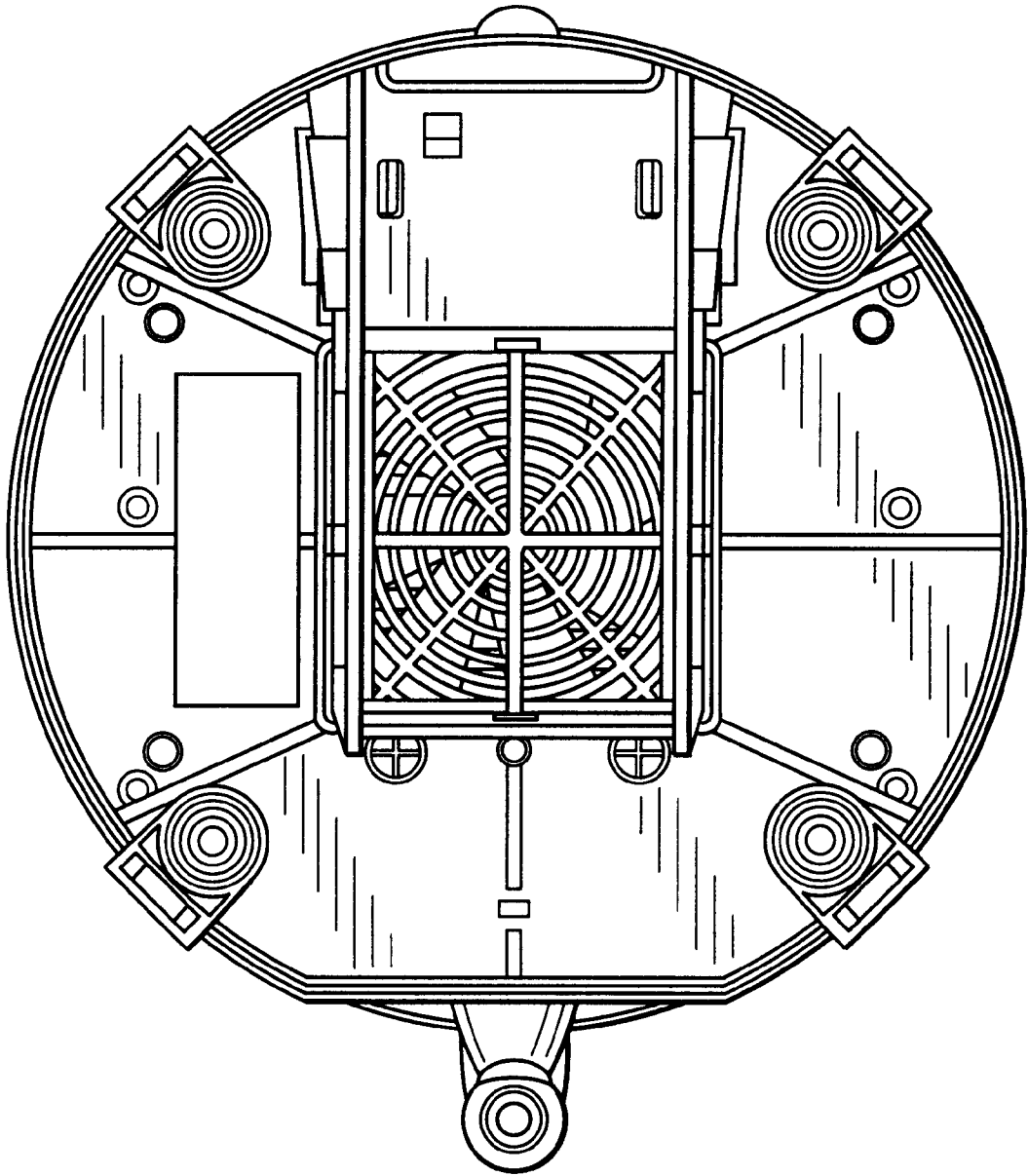

FIG. 6