



US00D805914S

(12) **United States Design Patent**  
**Jackman**

(10) **Patent No.:** **US D805,914 S**

(45) **Date of Patent:** **\*\* Dec. 26, 2017**

(54) **COMBINED PACKAGING CONTAINER AND TOY**

(71) Applicant: **Nichole Jackman**, Salt Lake City, UT (US)

(72) Inventor: **Nichole Jackman**, Salt Lake City, UT (US)

(\*\*) Term: **15 Years**

(21) Appl. No.: **29/562,160**

(22) Filed: **Apr. 22, 2016**

(51) **LOC (10) Cl.** ..... **09-01**

(52) **U.S. Cl.**  
USPC ..... **D9/636; D21/510**

(58) **Field of Classification Search**  
USPC ..... D3/270, 271.1–271.6; D7/510, 514–520, D7/599, 604, 613, 619.2, 623, 628; D9/600, 636–640, 414, 430–434; 206/457, 527, 531, 538; 215/381–384, 215/400; D21/506, 510  
CPC .... B65D 5/4258; B65D 81/60; B65D 81/365; B65D 81/366; B65D 81/368; B65D 2203/00; B65D 2203/02  
See application file for complete search history.

(56) **References Cited**

**U.S. PATENT DOCUMENTS**

D91,586 S \* 2/1934 McCollum ..... D9/636  
D93,880 S \* 11/1934 McCollum ..... D9/636  
D142,250 S \* 8/1945 Anthony ..... D21/510  
D169,888 S \* 6/1953 Beyer ..... D21/510

D173,819 S \* 1/1955 Seals ..... D9/636  
3,832,800 A \* 9/1974 Selesny ..... B65D 81/368  
446/77  
D262,902 S \* 2/1982 Duarte ..... D21/510  
D276,634 S \* 12/1984 Pope ..... D21/510  
D372,056 S \* 7/1996 Norton ..... D21/510  
6,299,060 B1 \* 10/2001 Garran ..... B65D 81/368  
206/457  
6,581,822 B1 \* 6/2003 Garran ..... B65D 81/368  
206/457  
D544,926 S \* 6/2007 Kassens ..... D21/506  
D664,859 S \* 8/2012 Puccioni ..... D9/636

\* cited by examiner

*Primary Examiner* — Sandra Morris

(74) *Attorney, Agent, or Firm* — Workman Nydegger

(57) **CLAIM**

The ornamental design for a combined packaging container and toy, as shown and described.

**DESCRIPTION**

FIG. 1 is a perspective view of a combined packaging container and toy showing the new design; FIG. 2 is another perspective view of the combined packaging container and toy in an open configuration of the new design; FIG. 3 is a front elevational view thereof; FIG. 4 is a rear elevational view thereof; FIG. 5 is a right side elevational view thereof; FIG. 6 is a left side elevational view thereof; FIG. 7 is a top plan view thereof; and, FIG. 8 is a bottom plan view thereof. The broken lines are for illustrative purposes only and form no part of the claimed design.

**1 Claim, 8 Drawing Sheets**

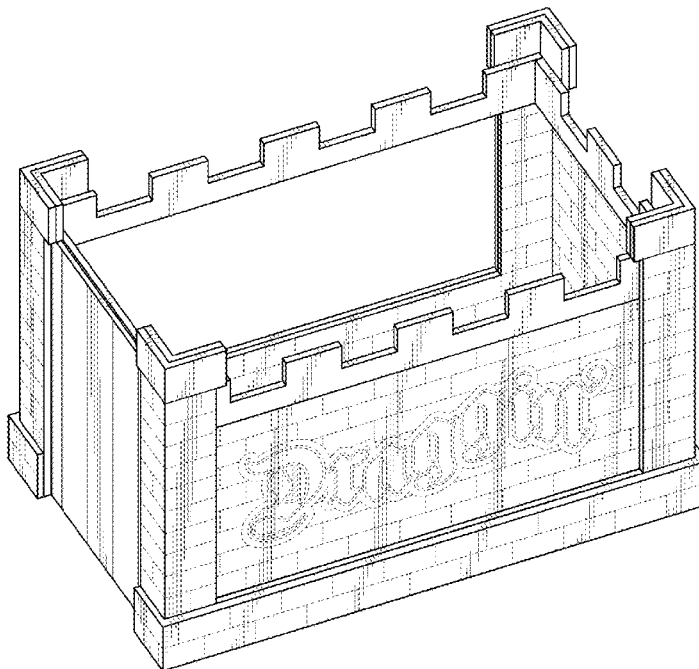

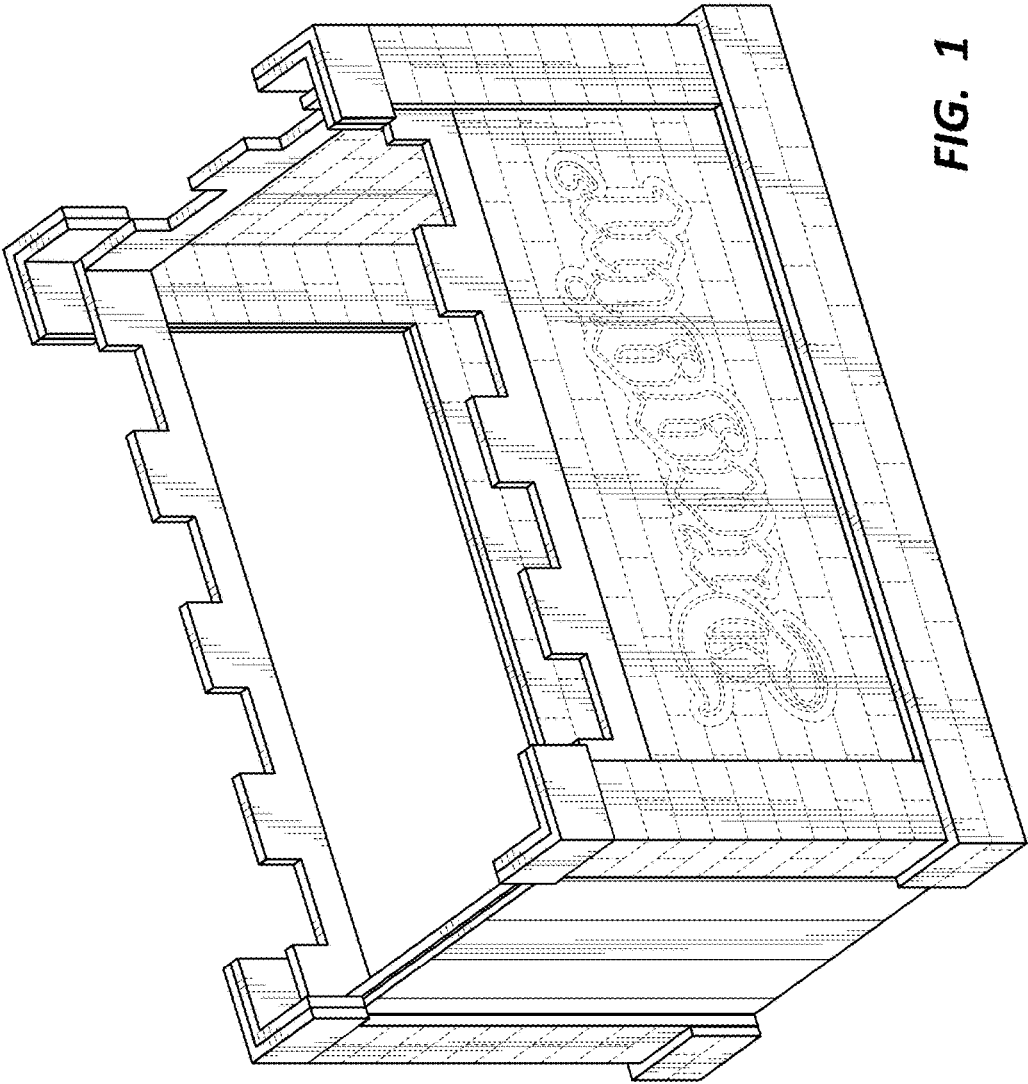

**FIG. 1**

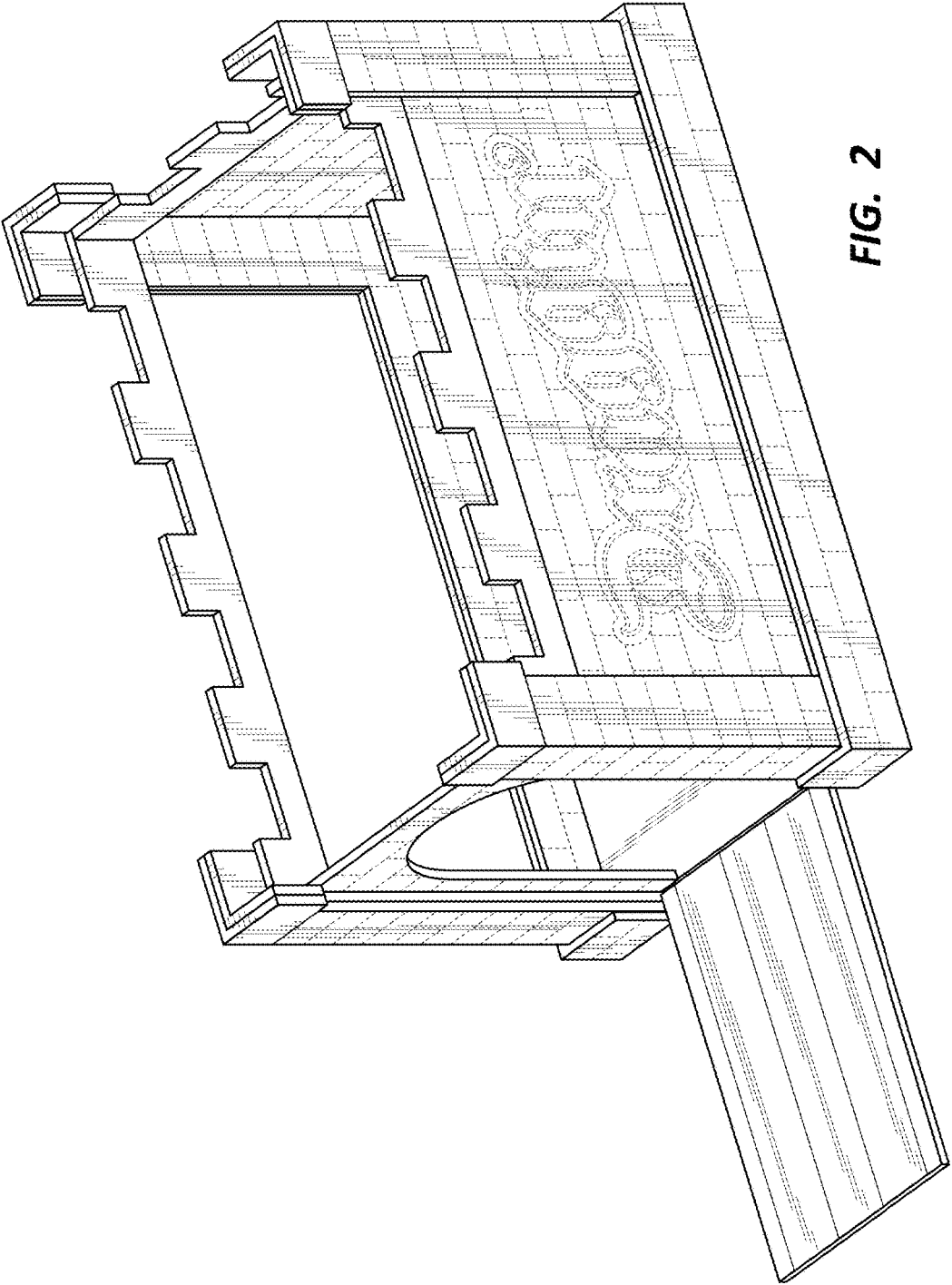
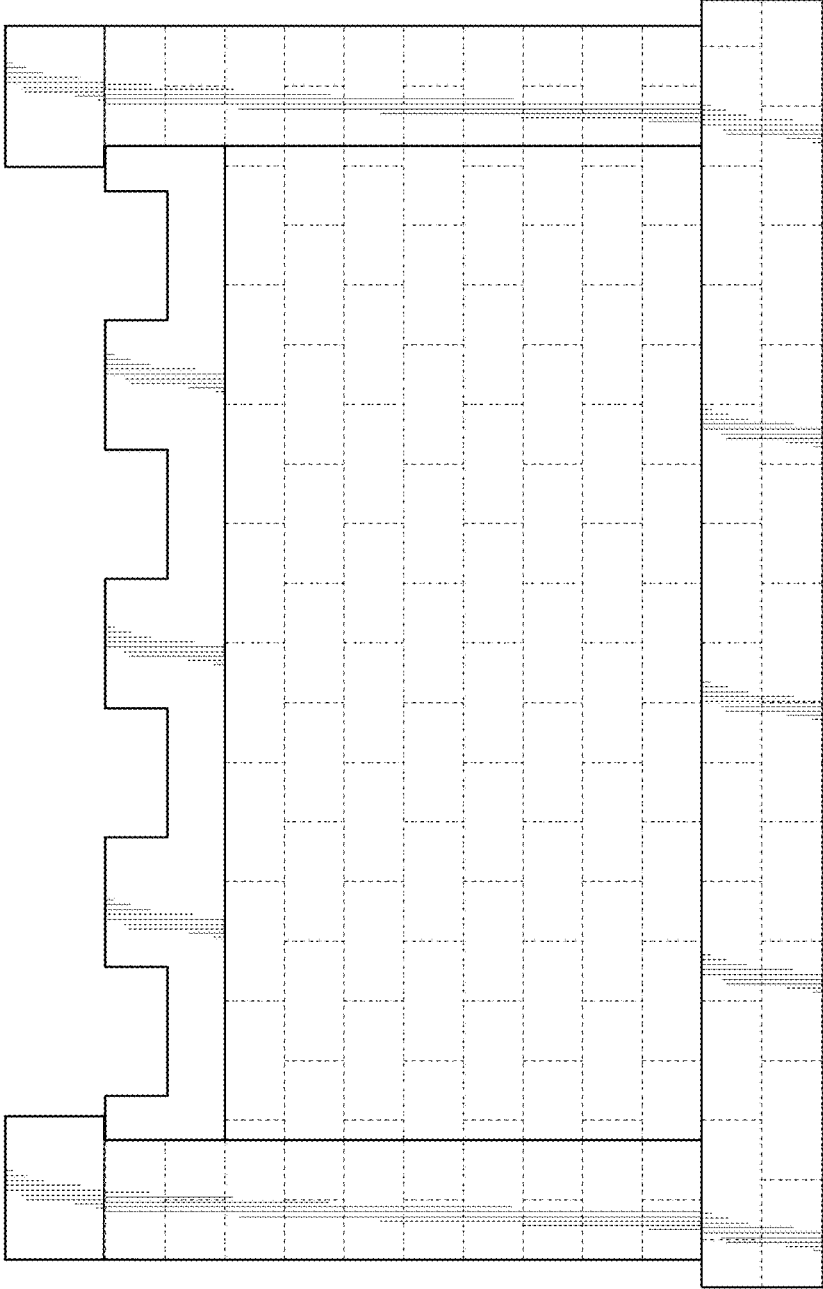
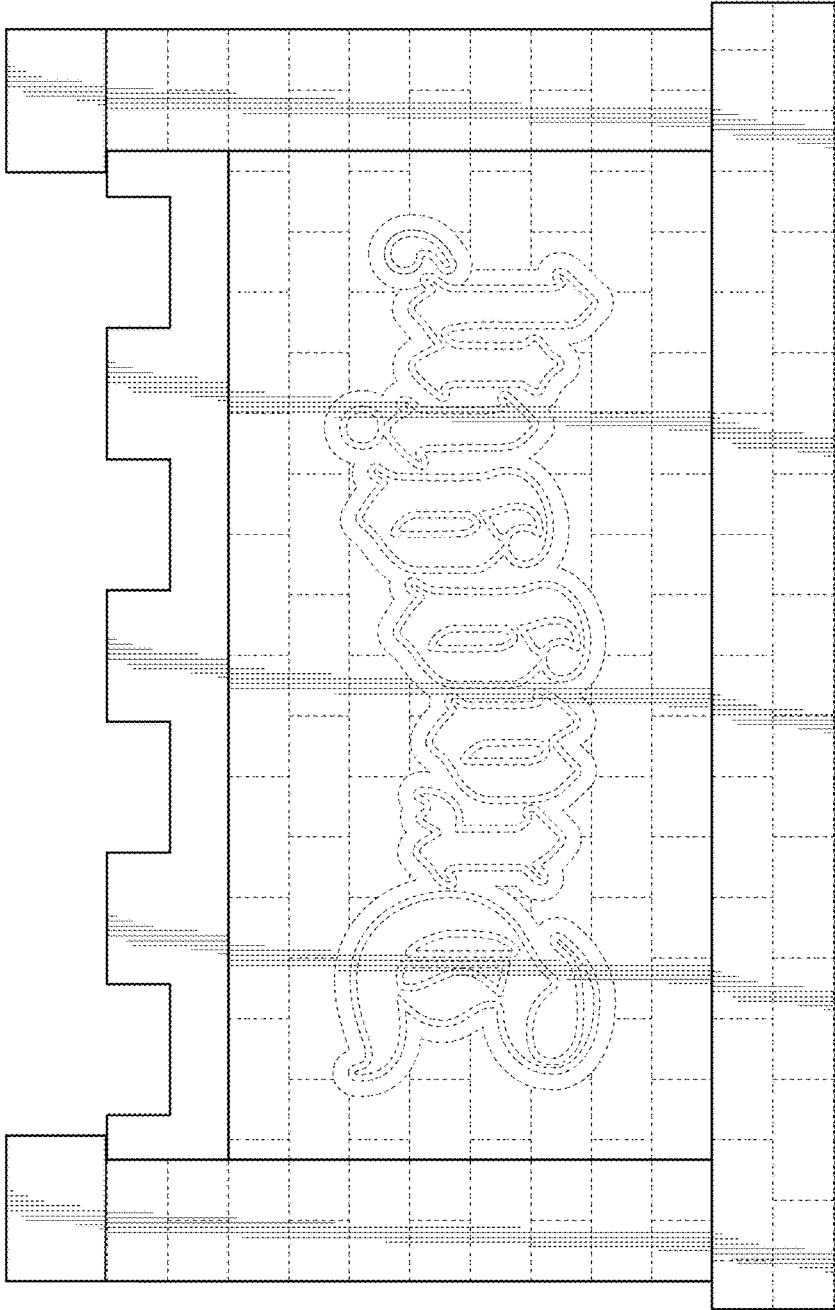

FIG. 2



**FIG. 3**



**FIG. 4**

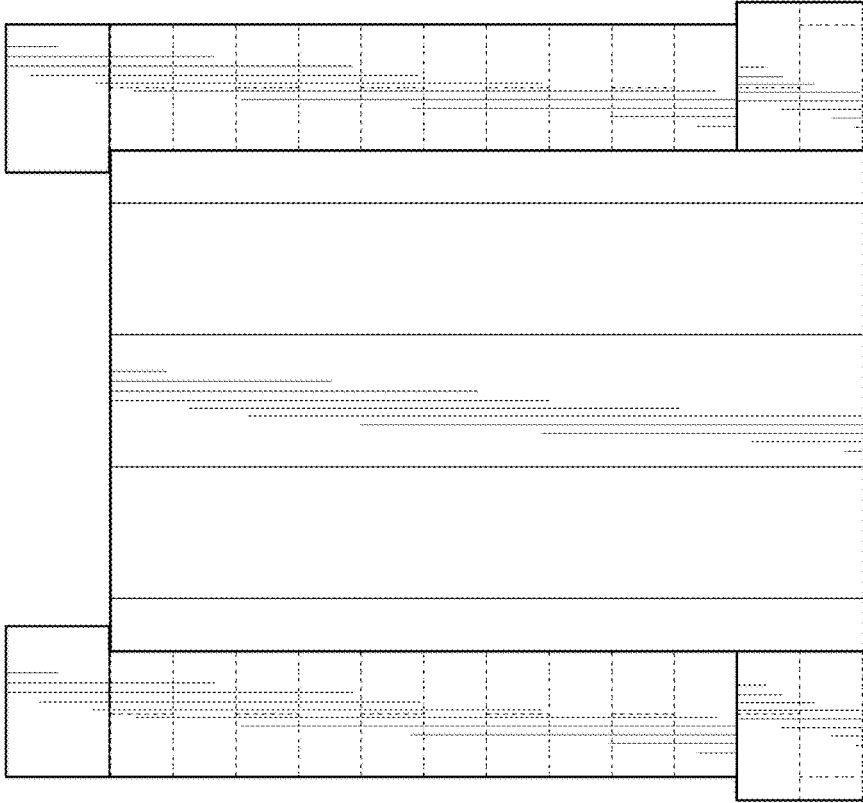
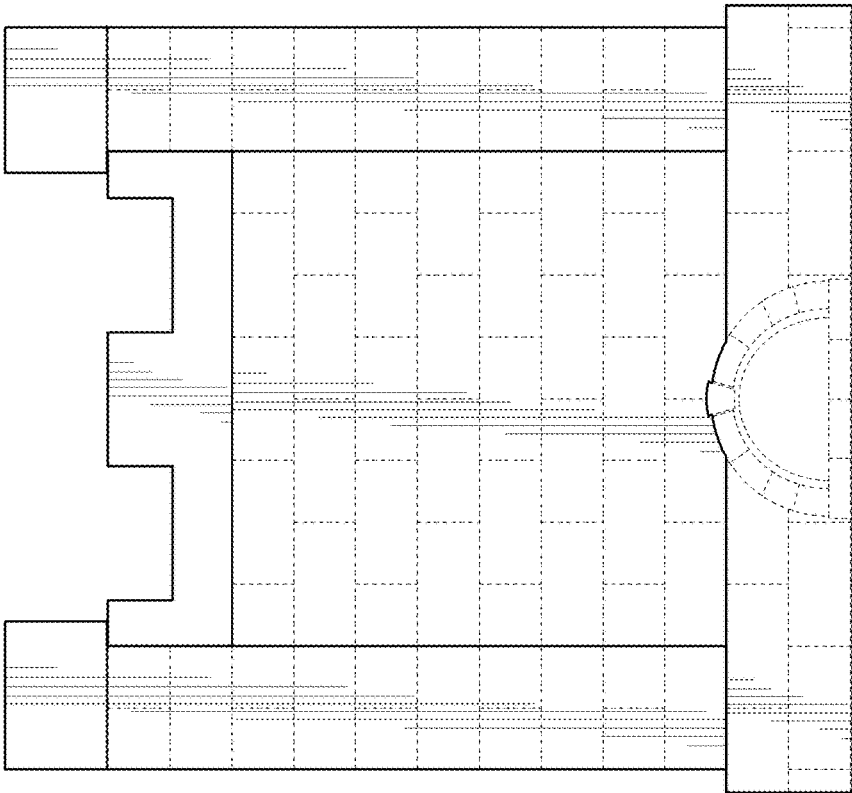
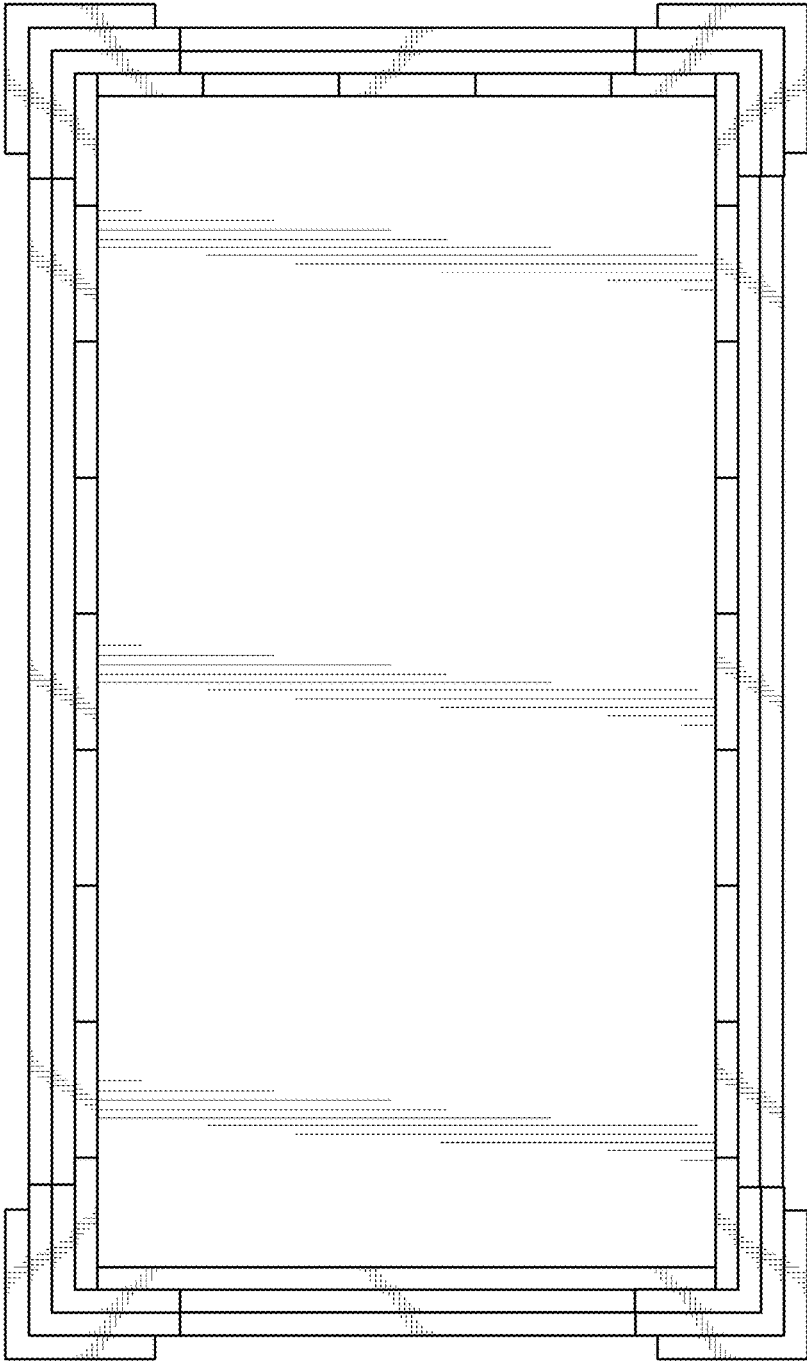

FIG. 5



**FIG. 6**



**FIG. 7**



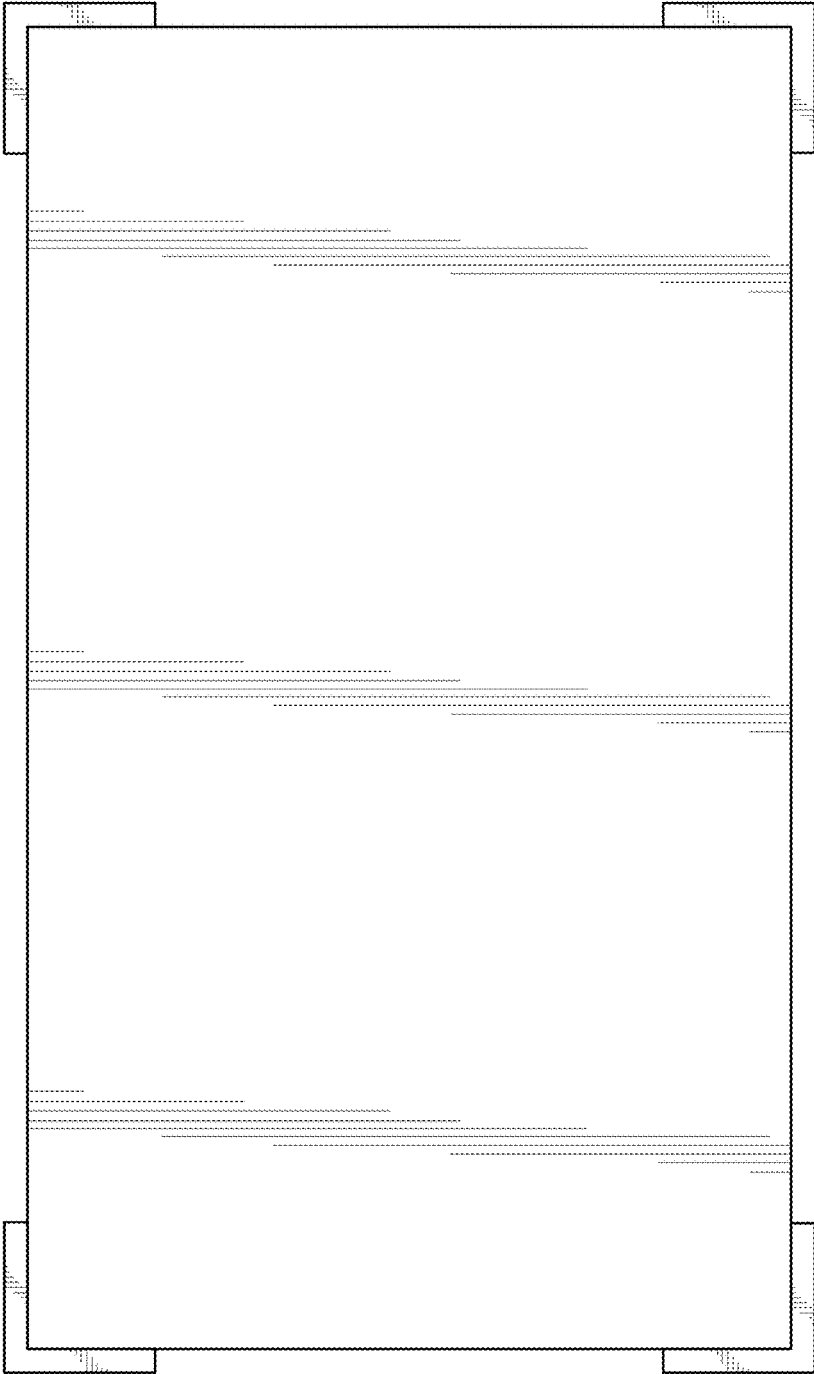

FIG. 8