



US0D1023199S

(12) **United States Design Patent**
Kuan et al.

(10) **Patent No.:** **US D1,023,199 S**

(45) **Date of Patent:** **** Apr. 16, 2024**

(54) **GOLF CLUB HEAD**

(71) Applicant: **SUMITOMO RUBBER INDUSTRIES, LTD.**, Kobe (JP)

(72) Inventors: **Jimmy H. Kuan**, West Covina, CA (US); **Isaac Chang**, Fullerton, CA (US)

(73) Assignee: **SUMITOMO RUBBER INDUSTRIES, LTD.**, Kobe (JP)

(**) Term: **15 Years**

(21) Appl. No.: **29/848,288**

(22) Filed: **Aug. 1, 2022**

(51) **LOC (14) Cl.** **21-02**

(52) **U.S. Cl.**
USPC **D21/746**

(58) **Field of Classification Search**
USPC D21/736–746, 759
CPC A63B 53/00; A63B 53/04; A63B 53/007;
A63B 53/065; A63B 53/0487; A63B
60/00; A63B 60/46
See application file for complete search history.

D930,097 S * 9/2021 Wang D21/744
D934,974 S * 11/2021 Cyrulik D21/759
D957,556 S * 7/2022 Tang D21/759
D957,557 S * 7/2022 Tang D21/759
D958,914 S * 7/2022 Rollinson D21/744
D972,673 S * 12/2022 Wang D21/744
D982,690 S * 4/2023 Toulon D21/743

(Continued)

FOREIGN PATENT DOCUMENTS

EM 015009704-0003 * 6/2023
JP D1753885 * 9/2023
KR 301225524.0000 * 7/2023

OTHER PUBLICATIONS

Golf putter head google search; google.com; Feb. 5, 2024.*
(Continued)

Primary Examiner — Mitchell I. Siegel
(74) *Attorney, Agent, or Firm* — Oliff PLC

(57) **CLAIM**

The ornamental design for a golf club head, as shown and described.

(56) **References Cited**

U.S. PATENT DOCUMENTS

D750,186 S * 2/2016 Schweigert D21/746
D825,699 S * 8/2018 Sillies D21/759
D827,064 S * 8/2018 Wypych D21/743
D834,118 S * 11/2018 Song D21/759
D842,952 S * 3/2019 Schweigert D21/743
D848,562 S * 5/2019 Nicolette D21/736
D864,325 S * 10/2019 Rollinson D21/743
D867,501 S * 11/2019 Chun D21/752
D892,956 S * 8/2020 Clarke D21/744
D895,041 S * 9/2020 Chun D21/752
D898,848 S * 10/2020 Clarke D21/743
D909,505 S * 2/2021 Schweigert D21/736
D909,506 S * 2/2021 Schweigert D21/736
D928,262 S * 8/2021 Cyrulik D21/759

DESCRIPTION

FIG. 1 is a front, heel-side, top perspective view of a golf club head, showing the new design;
FIG. 2 is a front elevational view thereof;
FIG. 3 is a rear elevational view thereof;
FIG. 4 is a toe-side elevational view thereof;
FIG. 5 is a heel-side elevational view thereof;
FIG. 6 is a top plan view thereof;
FIG. 7 is a bottom plan view thereof; and,
FIG. 8 is a rear, heel-side, bottom perspective view thereof.
The broken lines depict parts of the golf club head that form no part of the claimed design.

1 Claim, 8 Drawing Sheets

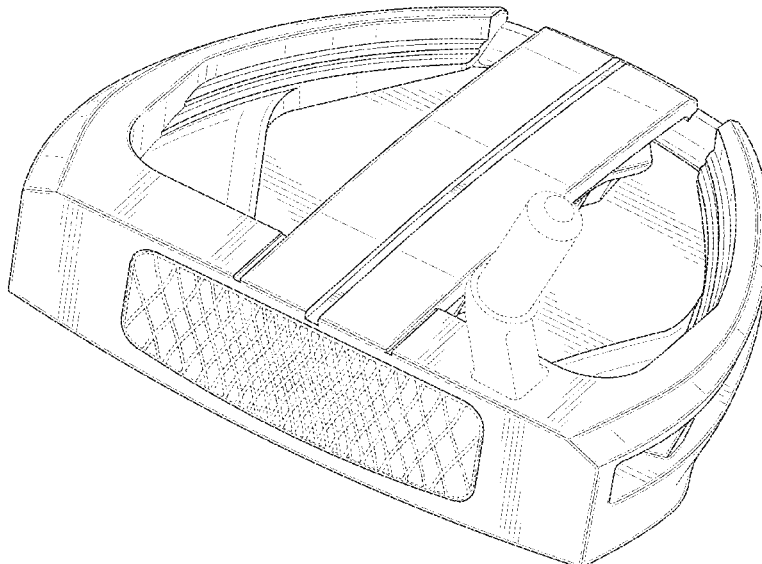

(56)

References Cited

U.S. PATENT DOCUMENTS

D1,005,426 S * 11/2023 Parsons D21/736

OTHER PUBLICATIONS

Cleveland golf putter head google search; google.com; Feb. 5, 2024.*
us.dunlopsports.com; Feb. 5, 2024.*

* cited by examiner

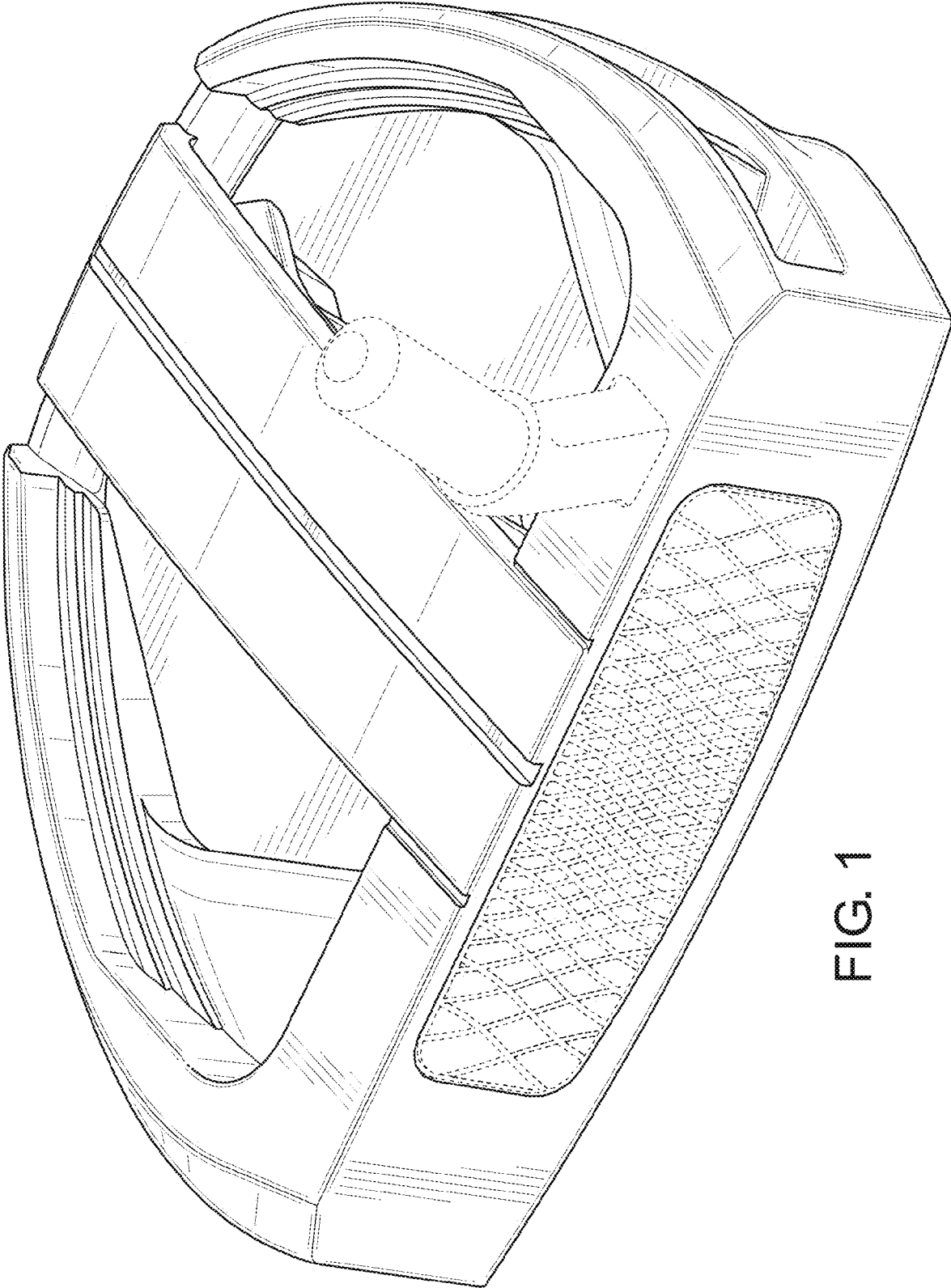

FIG. 1

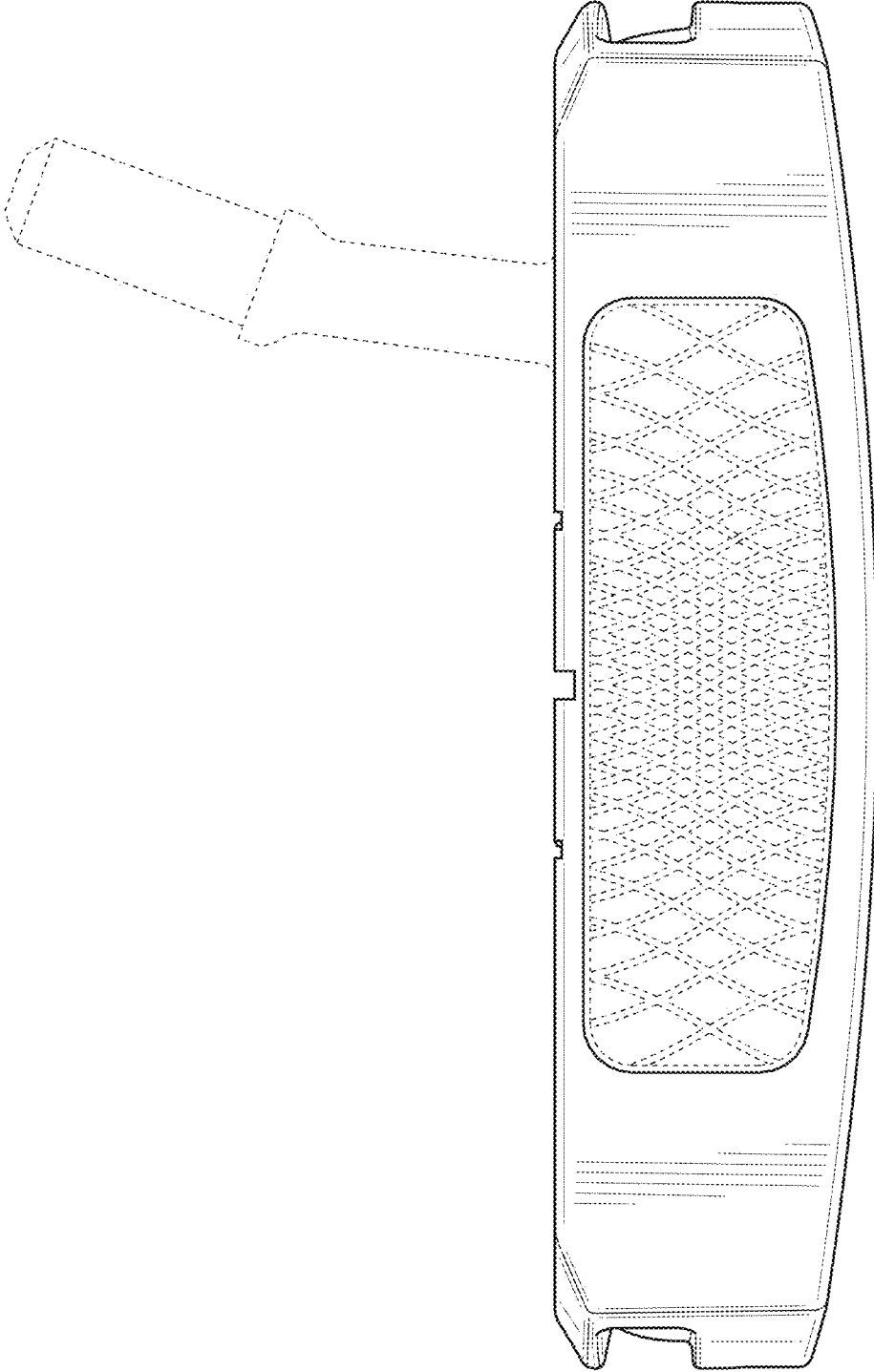

FIG. 2

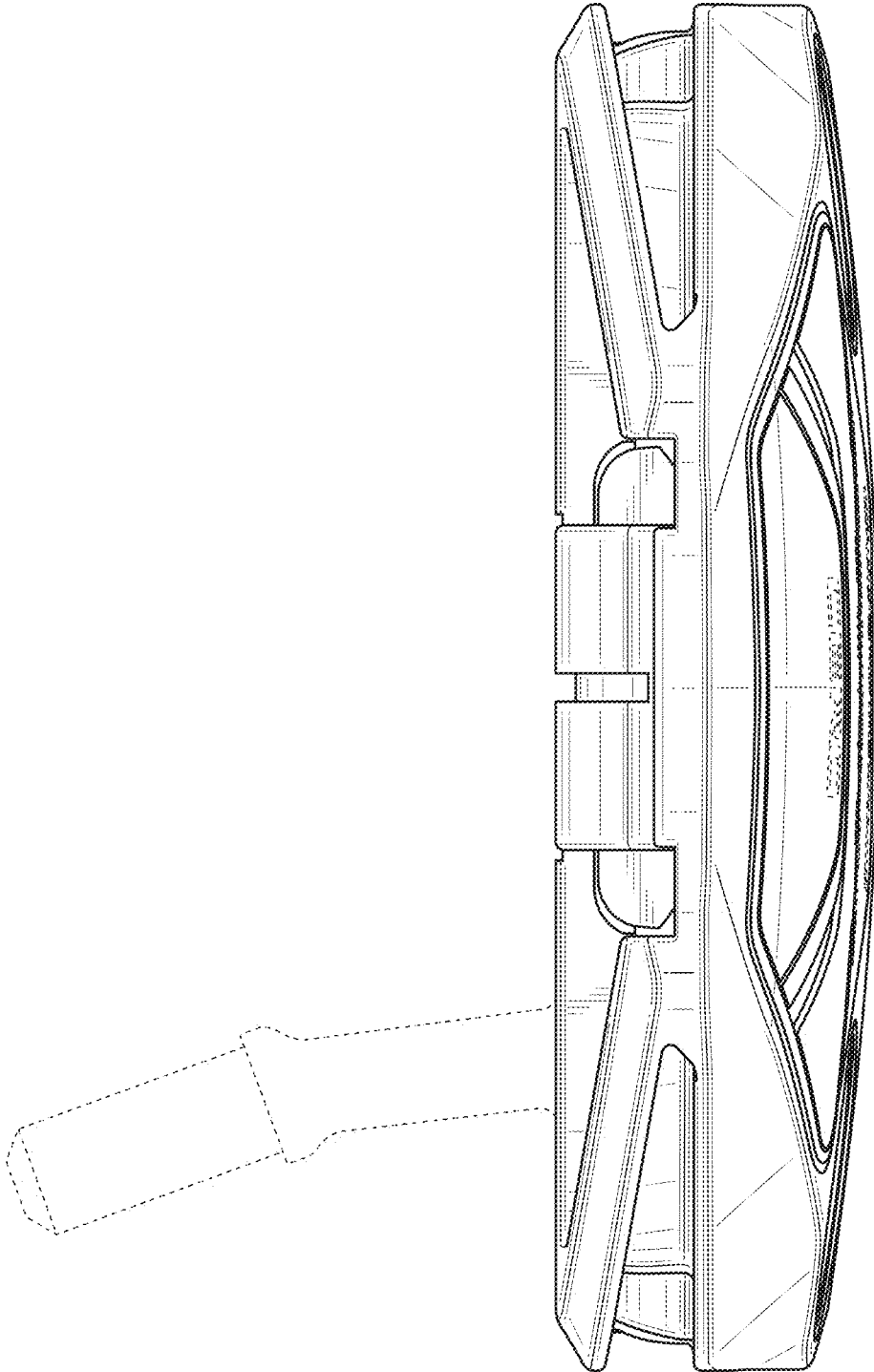

FIG. 3

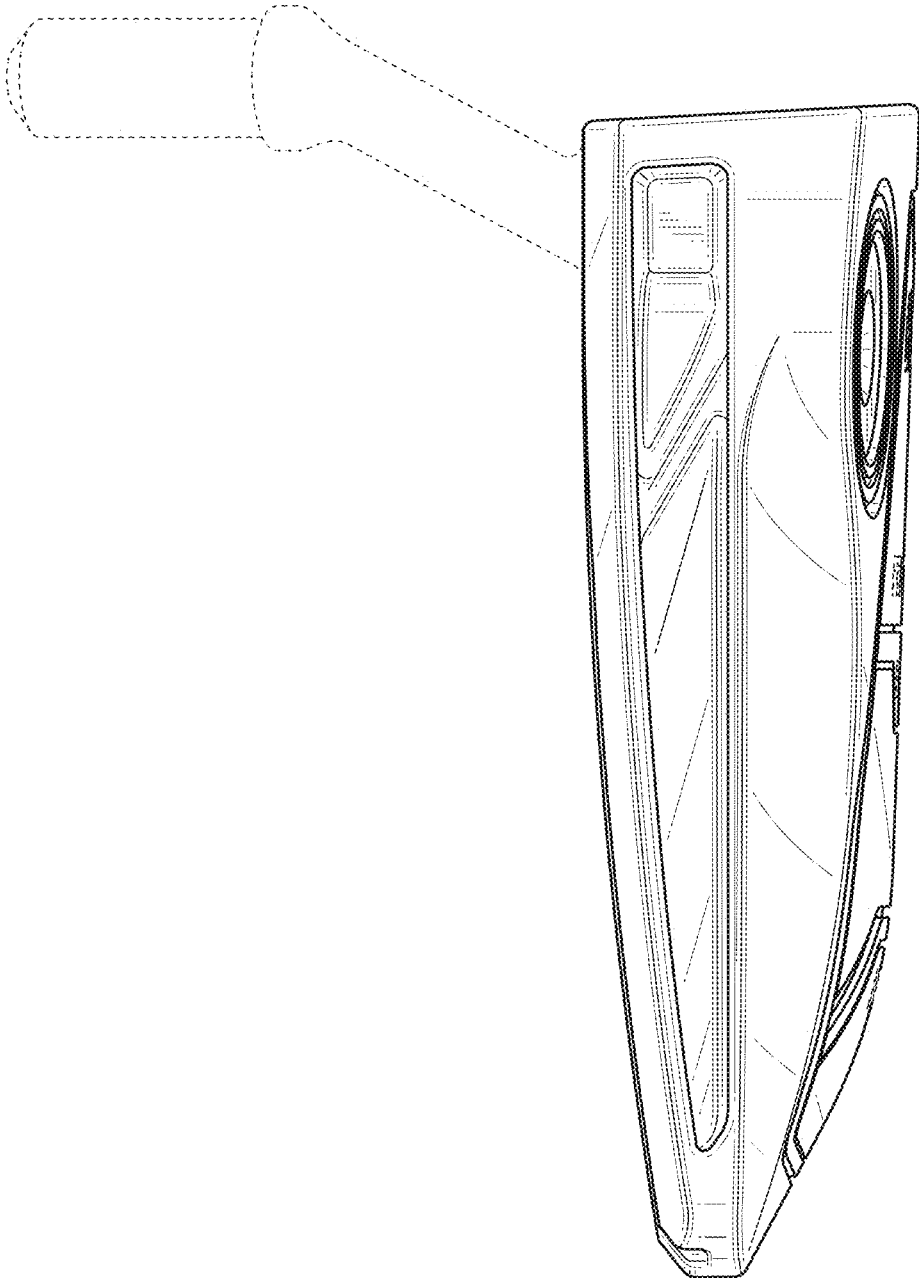

FIG. 4

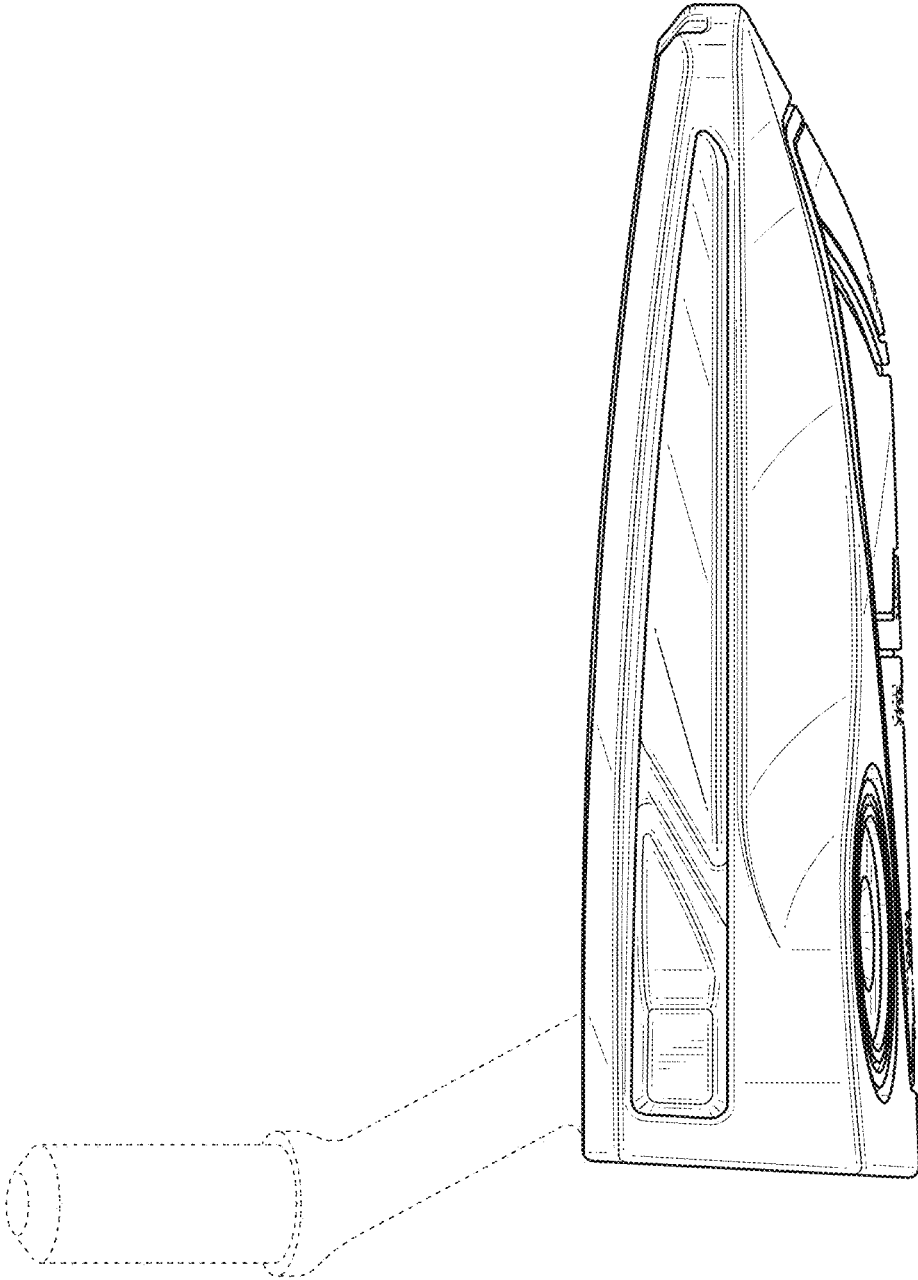

FIG. 5

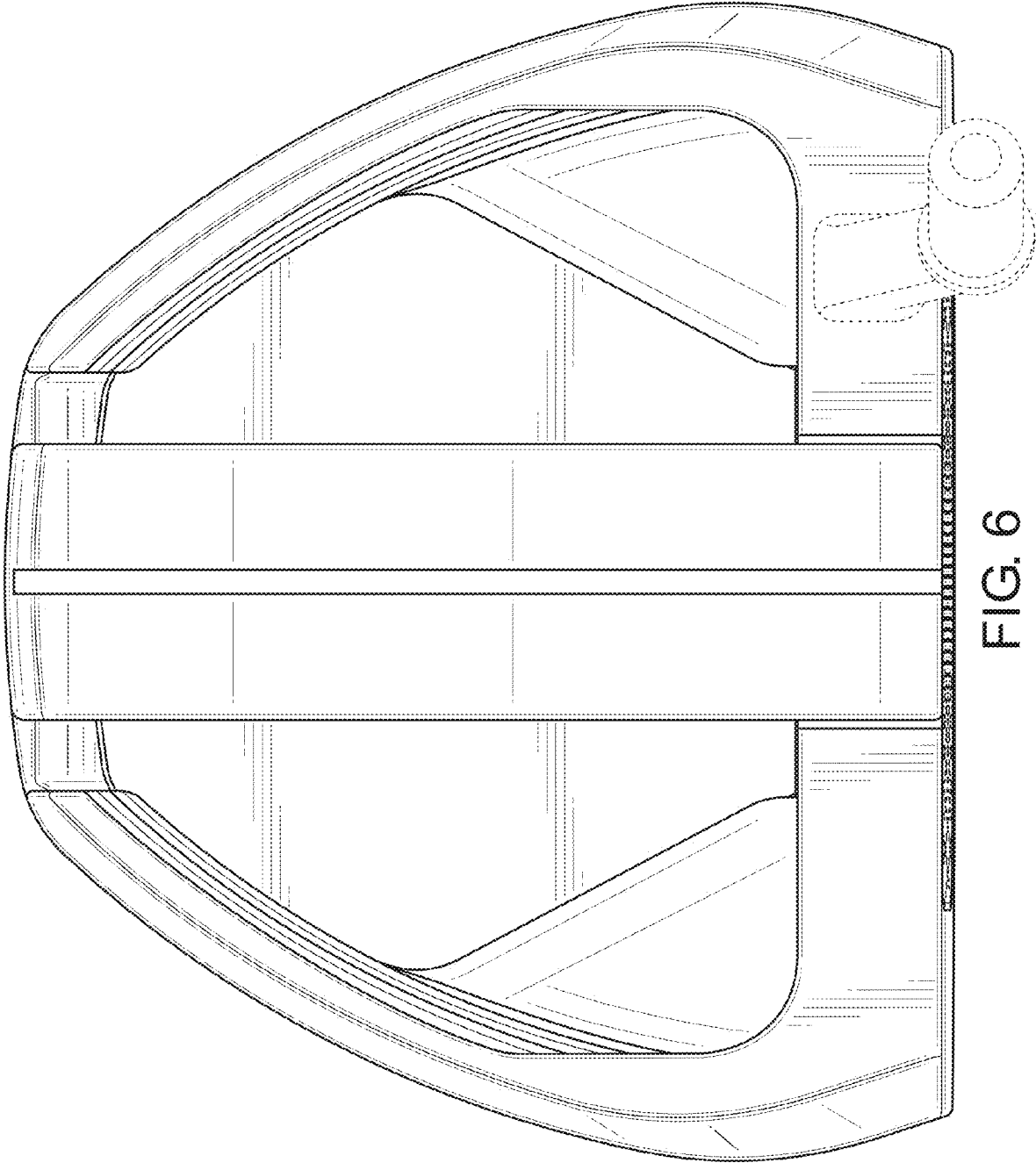

FIG. 6

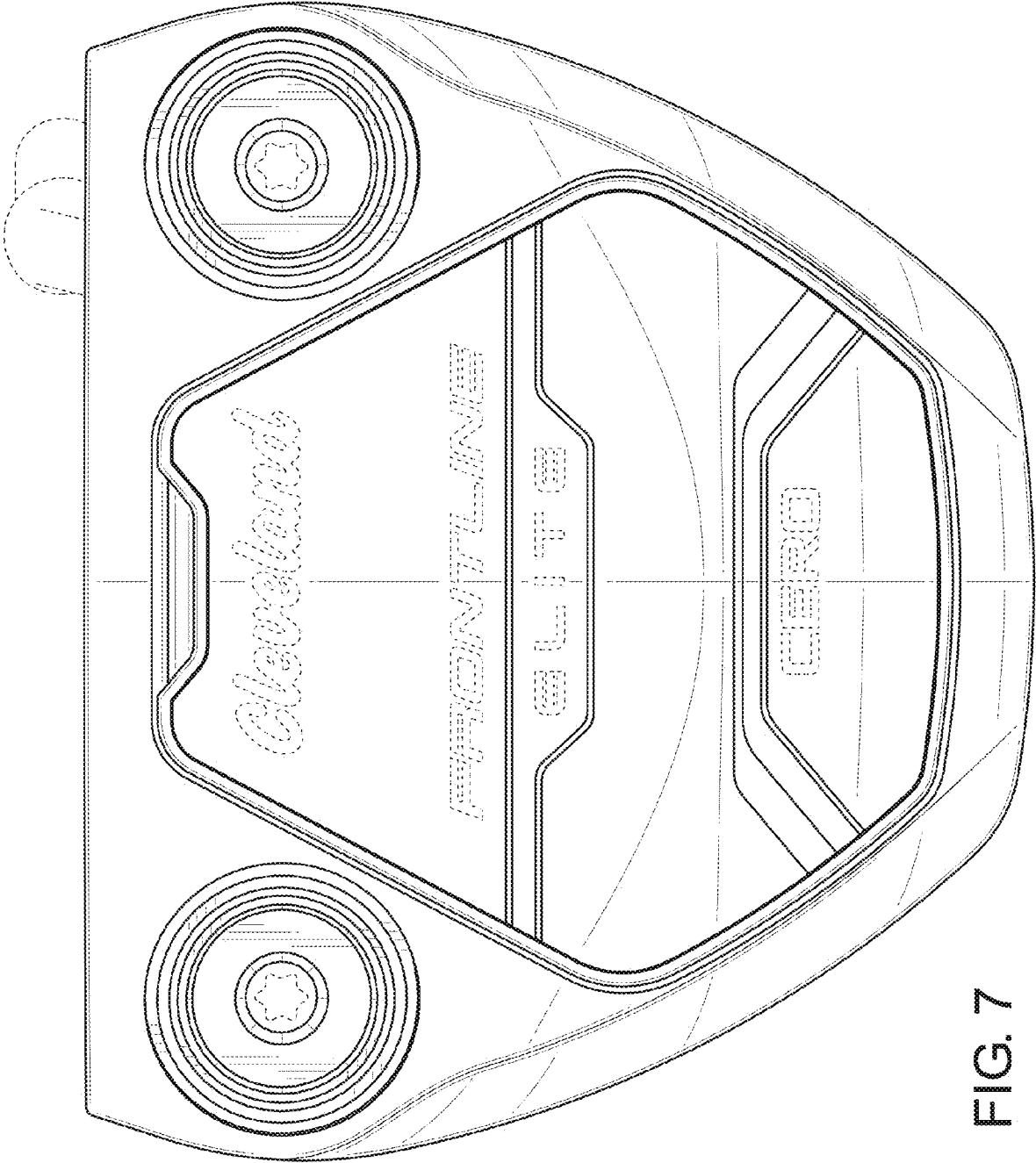

FIG. 7

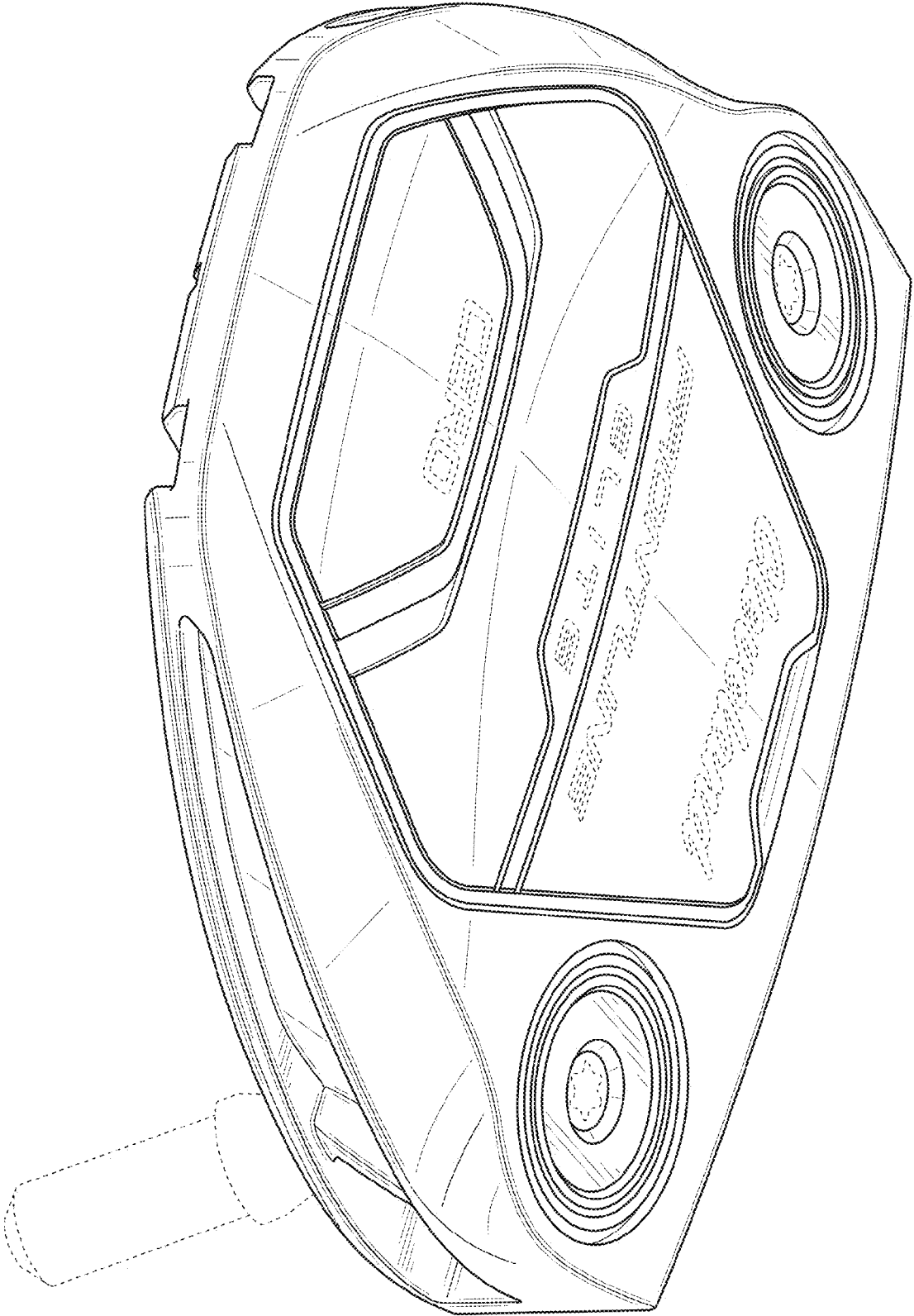

FIG. 8