



US00D913164S

(12) **United States Design Patent**  
**Kuriki et al.**

(10) **Patent No.:** **US D913,164 S**

(45) **Date of Patent:** **\*\* Mar. 16, 2021**

(54) **MOTORCYCLE OR MOTORCYCLE  
REPLICA**

D549,137 S \* 8/2007 Heinrich ..... D12/110  
D581,839 S \* 12/2008 Sasanami ..... D12/110  
D582,316 S \* 12/2008 Stenegard ..... D12/110  
D591,204 S \* 4/2009 Matsuzawa ..... D12/110

(Continued)

(71) Applicant: **HONDA MOTOR CO., LTD.**, Tokyo  
(JP)

(72) Inventors: **Daisuke Kuriki**, Tokyo (JP); **Yoshiyuki  
Ishiguri**, Tokyo (JP); **Jun Tanaka**,  
Tokyo (JP)

(73) Assignee: **HONDA MOTOR CO., LTD.**, Tokyo  
(JP)

(\*\*) Term: **15 Years**

(21) Appl. No.: **29/715,277**

(22) Filed: **Nov. 29, 2019**

(30) **Foreign Application Priority Data**

Jun. 7, 2019 (JP) ..... 2019-012551

(51) **LOC (13) Cl.** ..... **12-11**

(52) **U.S. Cl.**  
USPC ..... **D12/110**

(58) **Field of Classification Search**

USPC ..... D12/109, 110, 111, 114, 117, 126, 184,  
D12/186; D21/432, 458, 538

CPC ..... B62D 37/00; B62D 57/00; B62K 9/00;  
B62K 11/04; B62K 17/00; B62K 19/48;  
B62M 7/12; F02B 61/02; A63H 17/21;  
B62J 17/00; B62J 17/04; B62J 29/00

See application file for complete search history.

(56) **References Cited**

**U.S. PATENT DOCUMENTS**

D491,110 S \* 6/2004 Uchiyama ..... D12/110  
D492,222 S \* 6/2004 Uchiyama ..... D12/110  
D496,309 S \* 9/2004 Fukumoto ..... D12/110  
D497,843 S \* 11/2004 Kato ..... D12/110  
D504,844 S \* 5/2005 Sasanami ..... D12/110  
D517,956 S \* 3/2006 Kishi ..... D12/110

**OTHER PUBLICATIONS**

“Kawasaki Ninja® 650” Kawaski., posted date Oct. 11, 2018  
[online], [retrieved on Dec. 9, 2020]. Retrieved from the Internet  
<URL: <https://www.kawasaki.com/en-us/motorcycle/ninja/sport/ninja-650>> (Year: 2018).\*

(Continued)

*Primary Examiner* — Darlington Ly

*Assistant Examiner* — Nasim Abdulaziz Ali

(74) *Attorney, Agent, or Firm* — Birch, Stewart, Kolasch  
& Birch, LLP

(57) **CLAIM**

The ornamental design for a motorcycle or motorcycle  
replica, as shown and described.

**DESCRIPTION**

FIG. 1 is a front and right side perspective view of a  
motorcycle or motorcycle replica embodying our new  
design;

FIG. 2 is a rear and right side perspective view thereof;

FIG. 3 is a front and left side perspective view thereof;

FIG. 4 is a rear and left side perspective view thereof;

FIG. 5 is a right side elevation view thereof;

FIG. 6 is a left side elevation view thereof;

FIG. 7 is a front elevation view thereof;

FIG. 8 is a rear elevation view thereof;

FIG. 9 is a top plan view thereof; and,

FIG. 10 is a bottom plan view thereof.

The broken lines shown in the drawings illustrate portions of  
the motorcycle or motorcycle replica that form no part of the  
claimed design.

**1 Claim, 10 Drawing Sheets**

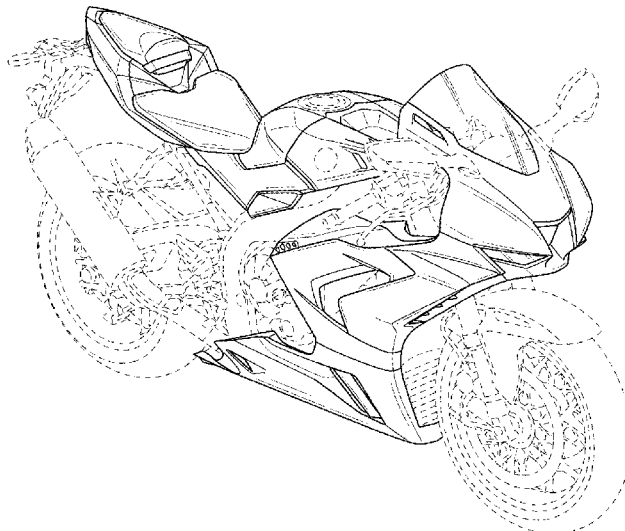

(56)

References Cited

U.S. PATENT DOCUMENTS

D591,205 S \* 4/2009 Heinrich ..... D12/110  
 D594,786 S \* 6/2009 Sakata ..... D12/110  
 D601,458 S \* 10/2009 Nagao ..... D12/110  
 D610,045 S \* 2/2010 Lambri ..... D12/110  
 D610,046 S \* 2/2010 Miyake ..... D12/110  
 D611,390 S \* 3/2010 Toriyama ..... D12/110  
 D627,689 S \* 11/2010 Ishiguri ..... D12/110  
 D662,859 S \* 7/2012 Matsuoka ..... D12/110  
 D666,533 S \* 9/2012 Wilm ..... D12/110  
 D686,538 S \* 7/2013 Nagao ..... D12/110  
 D689,406 S \* 9/2013 Yasuhara ..... D12/110  
 D694,673 S \* 12/2013 Katagiri ..... D12/110  
 D723,431 S \* 3/2015 Noguchi ..... D12/110  
 D736,677 S \* 8/2015 Iimura ..... D12/110  
 D755,084 S \* 5/2016 Sakata ..... D12/110  
 D755,680 S \* 5/2016 Yashuhara ..... D12/110  
 D814,359 S \* 4/2018 Nishimoto ..... D12/110  
 D876,990 S \* 3/2020 Yoshitomi ..... D12/110  
 D877,660 S \* 3/2020 Katagiri ..... D12/110  
 D886,685 S \* 6/2020 Zhang ..... D12/110  
 D901,607 S \* 11/2020 Tearne ..... D21/538

D903,008 S \* 11/2020 Tearne ..... D21/538  
 D903,009 S \* 11/2020 Tearne ..... D21/538  
 10,865,707 B2 \* 12/2020 Taki ..... F02B 61/02  
 2019/0302452 A1 \* 10/2019 Nishida ..... B62K 23/02  
 2020/0247494 A1 \* 8/2020 Ichikawa ..... B60L 53/18  
 2020/0277016 A1 \* 9/2020 Kobayashi ..... B62J 43/20

OTHER PUBLICATIONS

“2019 G 310 GS” BMW., posted date Nov. 10, 2017 [online],  
 [retrieved on Dec. 9, 2020]. Retrieved from the Internet <URL:  
<https://www.bmwmotorcycles.com/en/models/adventure/g310gs.html>  
 > (Year: 2017).\*  
 “2021 S 1000 XR” BMW., posted date Nov. 5, 2019 [online],  
 [retrieved on Dec. 9, 2020]. Retrieved from the Internet <URL:  
<https://www.bmwmotorcycles.com/en/models/adventure/s1000xr.html>  
 > (Year: 2019).\*  
 “8 Best Newest 2020 BMW Motorcycles” (via YouTube), posted  
 date May 19, 2020 [online], [retrieved on Dec. 9, 2020 ]. Video  
 retrieved from internet <URL:<https://www.youtube.com/watch?v=T4eAPQqL0zY>> (Year: 2020).\*

\* cited by examiner

FIG. 1

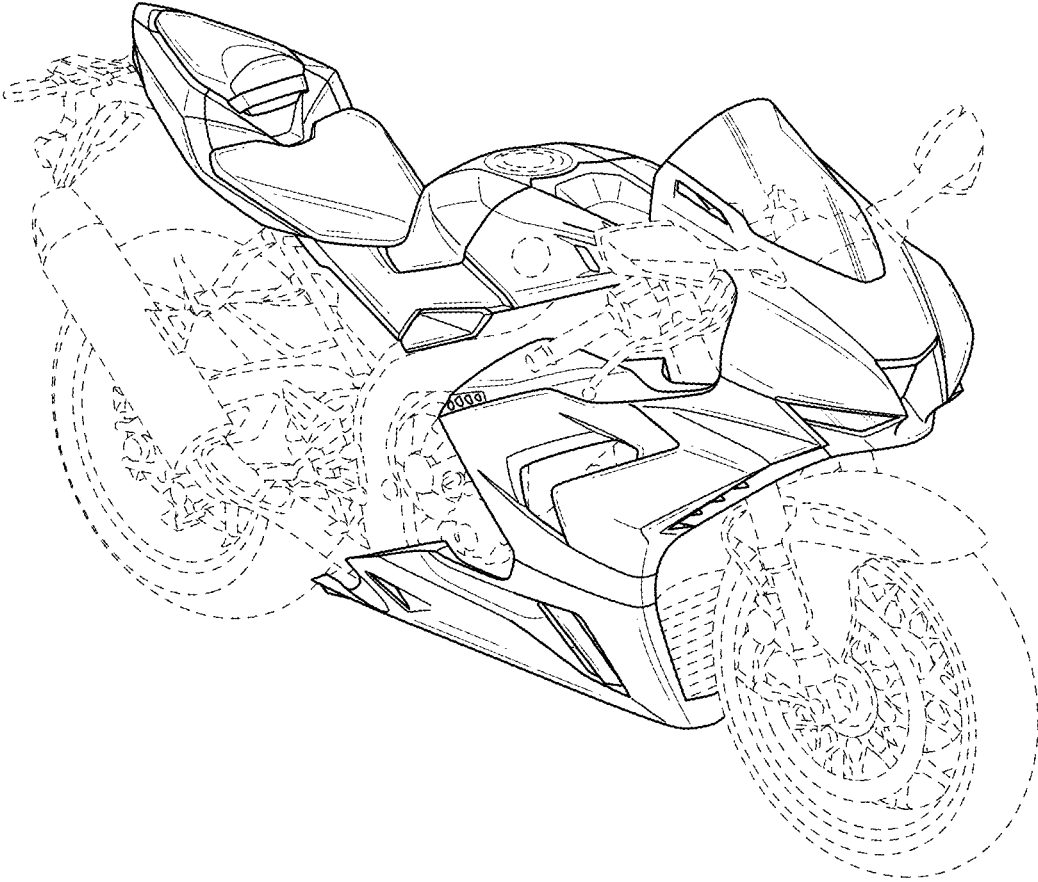

FIG. 2

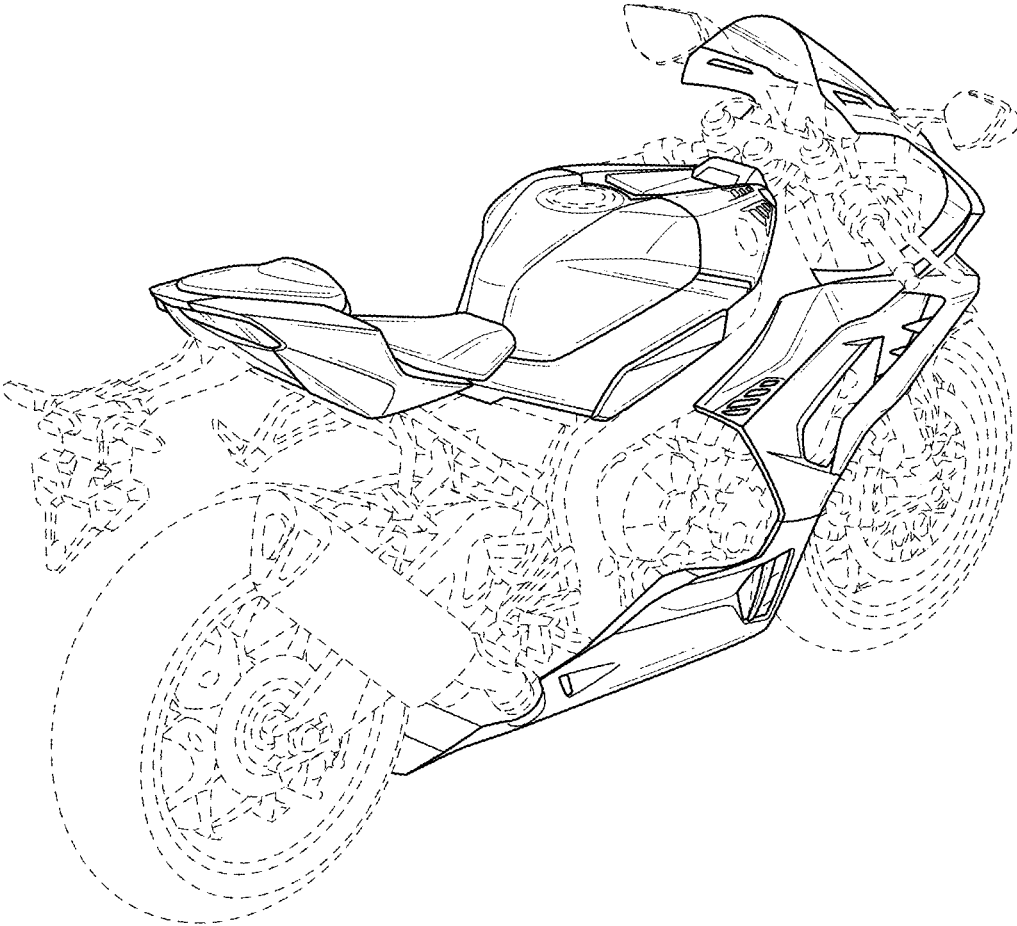

FIG. 3

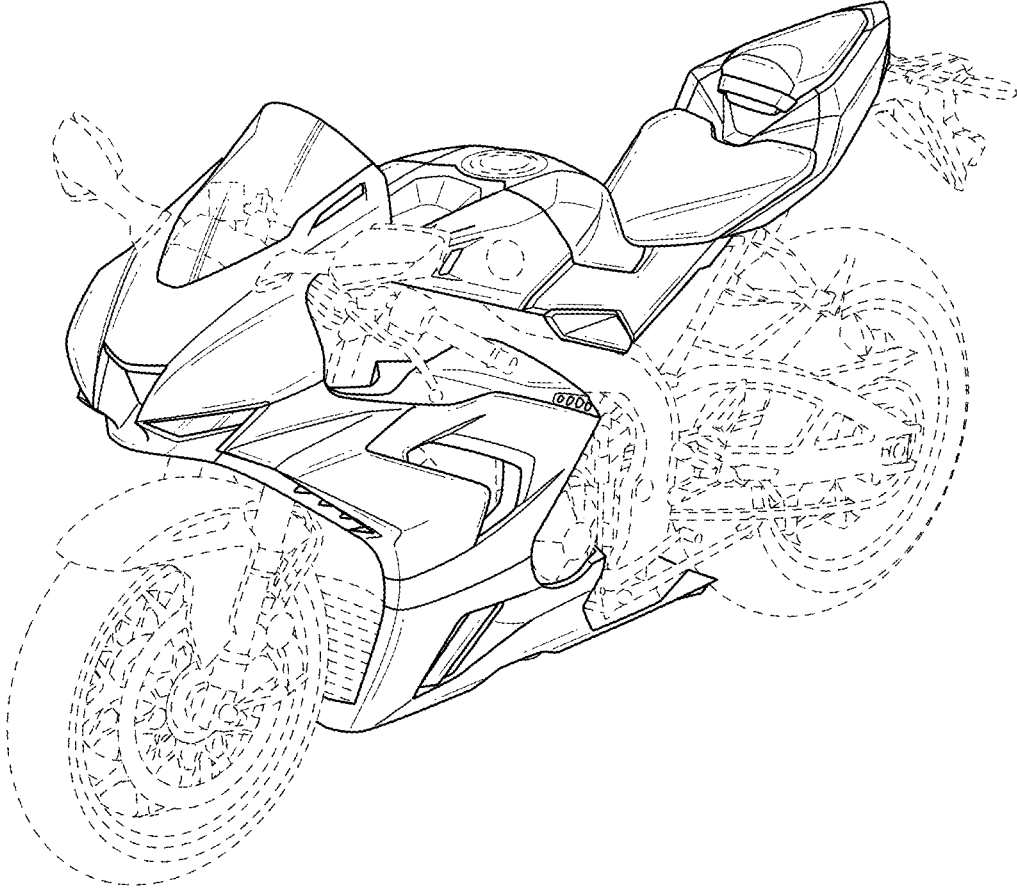

FIG. 4

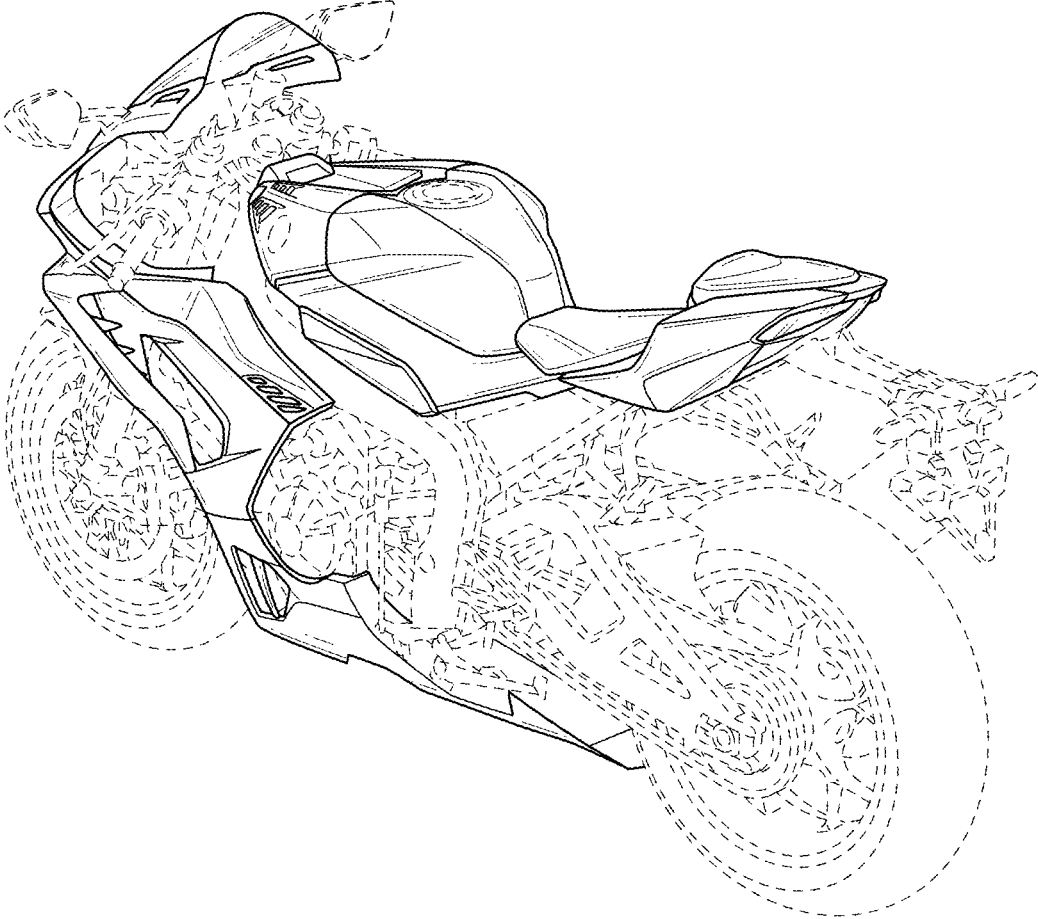

FIG. 5

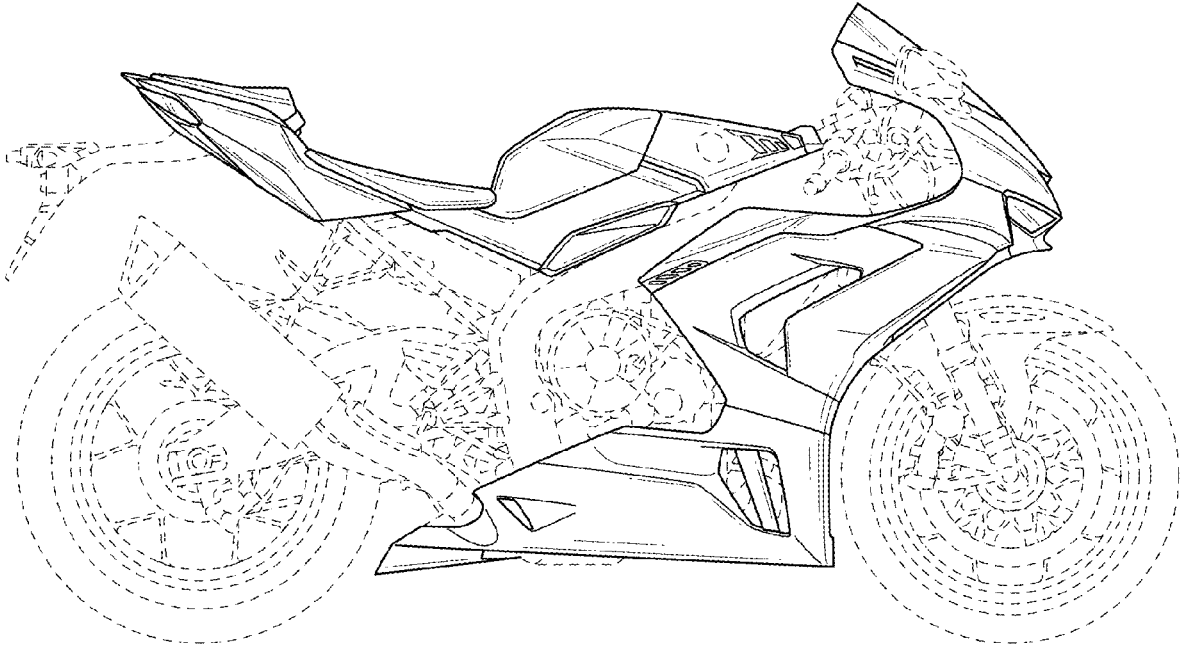

FIG. 6

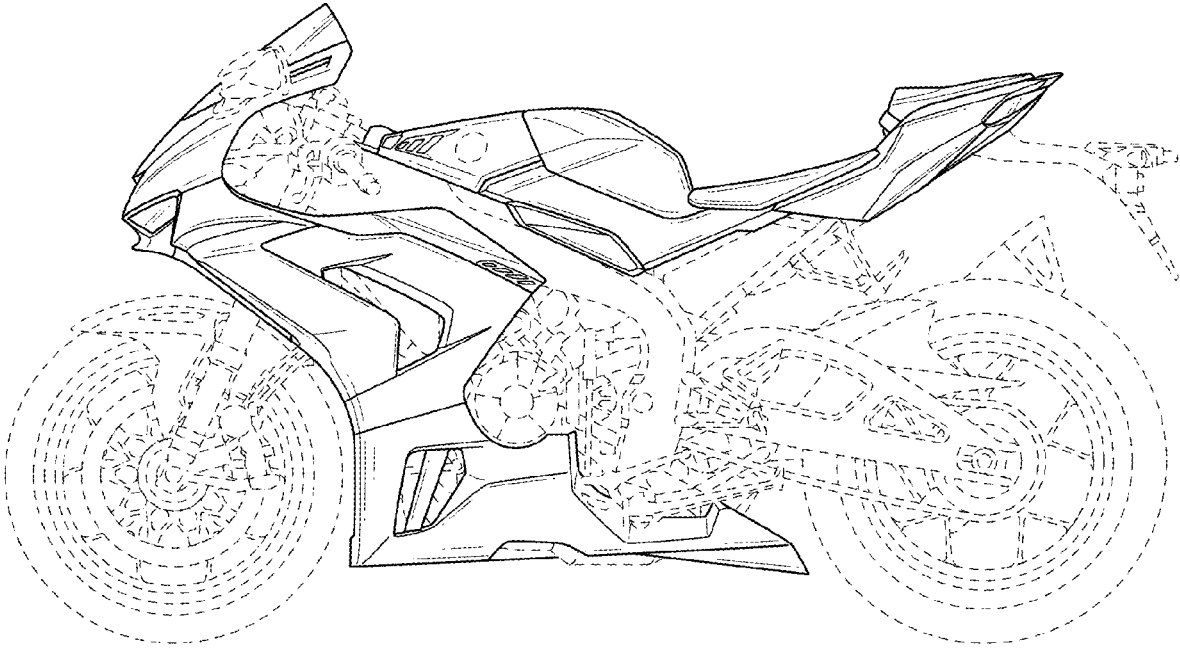



FIG. 7

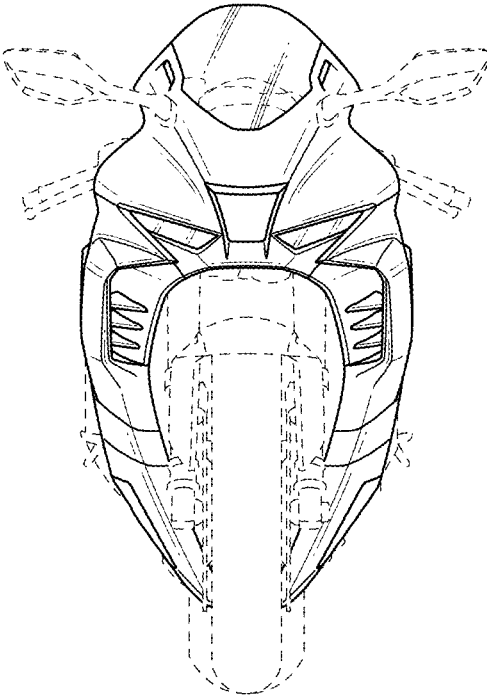

FIG. 8

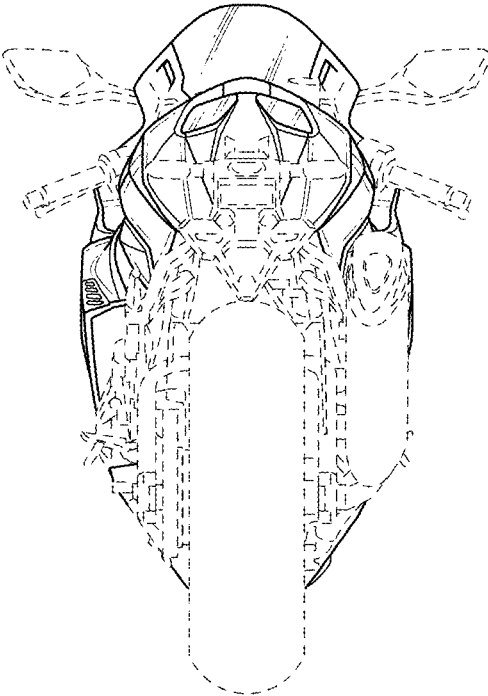

FIG. 9

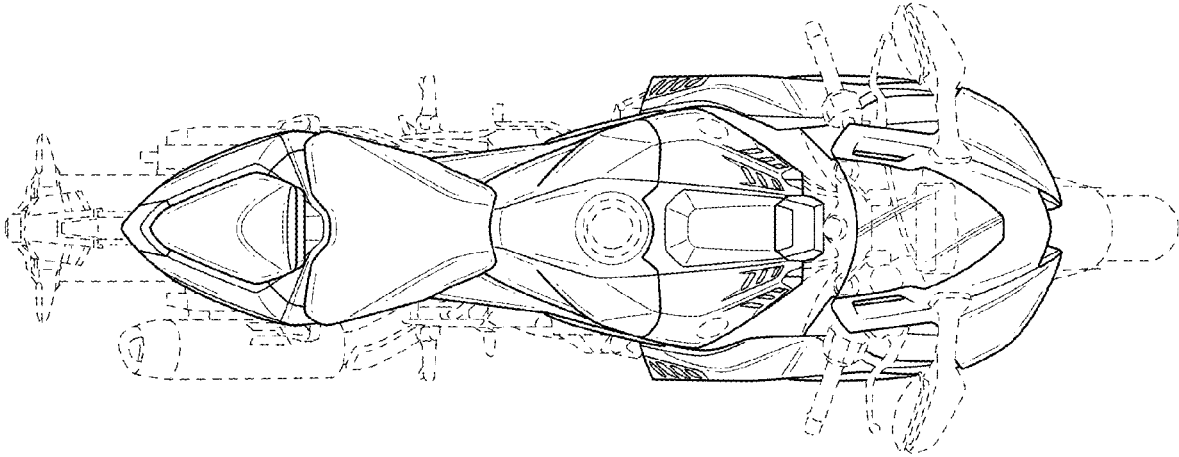

FIG. 10

