



US00D690147S

(12) **United States Design Patent**
Meyer

(10) **Patent No.:** **US D690,147 S**

(45) **Date of Patent:** **** Sep. 24, 2013**

(54) **SEAT SHELL**

(71) Applicant: **Indecom N.V.**, Rhenen (NL)

(72) Inventor: **Just Meyer**, Rhenen (NL)

(73) Assignee: **Indecom N.V.**, Rhenen (NL)

(**) Term: **14 Years**

(21) Appl. No.: **29/446,087**

(22) Filed: **Feb. 20, 2013**

(51) **LOC (9) Cl.** **06-01**

(52) **U.S. Cl.**
USPC **D6/716; D6/375**

(58) **Field of Classification Search**
USPC D6/334-336, 341, 371-373, 374,
D6/375, 376, 379, 380, 716, 716.1, 716.2,
D6/716.3, 716.4; 297/239, 445.1, 446.1,
297/452.2, 452.12, 452.19, 452.21, 452.29
See application file for complete search history.

(56) **References Cited**

U.S. PATENT DOCUMENTS

D142,800 S * 11/1945 Eames D6/375
D178,880 S * 10/1956 Hauser D6/375

D181,270 S * 10/1957 Barecki et al. D6/375
2,812,800 A * 11/1957 Eames 297/239
D181,601 S * 12/1957 Pike D6/375
D181,702 S * 12/1957 Bargaen D6/375
2,893,469 A * 7/1959 Eames et al. 297/239
D192,029 S * 1/1962 Avedon et al. D6/375
D200,638 S * 3/1965 Midyette, Jr. D6/375
D214,622 S * 7/1969 Schier et al. D6/375
D230,669 S * 3/1974 Hendrickson D6/341
D549,018 S * 8/2007 Glass et al. D6/716

* cited by examiner

Primary Examiner — Mimosa De

(74) *Attorney, Agent, or Firm* — Laurence A. Greenberg;
Werner H. Stemer; Ralph E. Locher

(57) **CLAIM**

The ornamental design for a seat shell, as shown and described.

DESCRIPTION

FIG. 1 is a front perspective view of the seat shell, showing my new design;

FIG. 2 is a front elevation view thereof;

FIG. 3 is a rear elevation view thereof;

FIG. 4 is a side elevation view thereof;

FIG. 5 is a top plan view thereof; and,

FIG. 6 is a bottom plan view thereof.

1 Claim, 6 Drawing Sheets

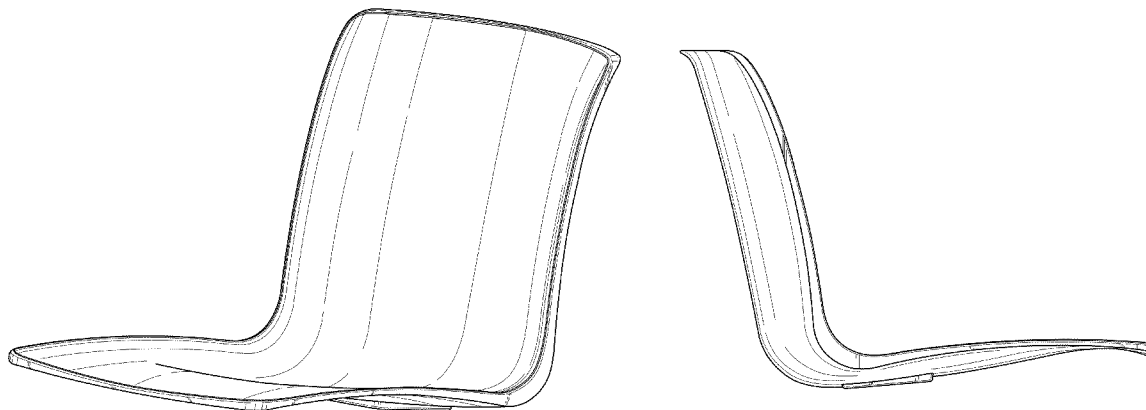

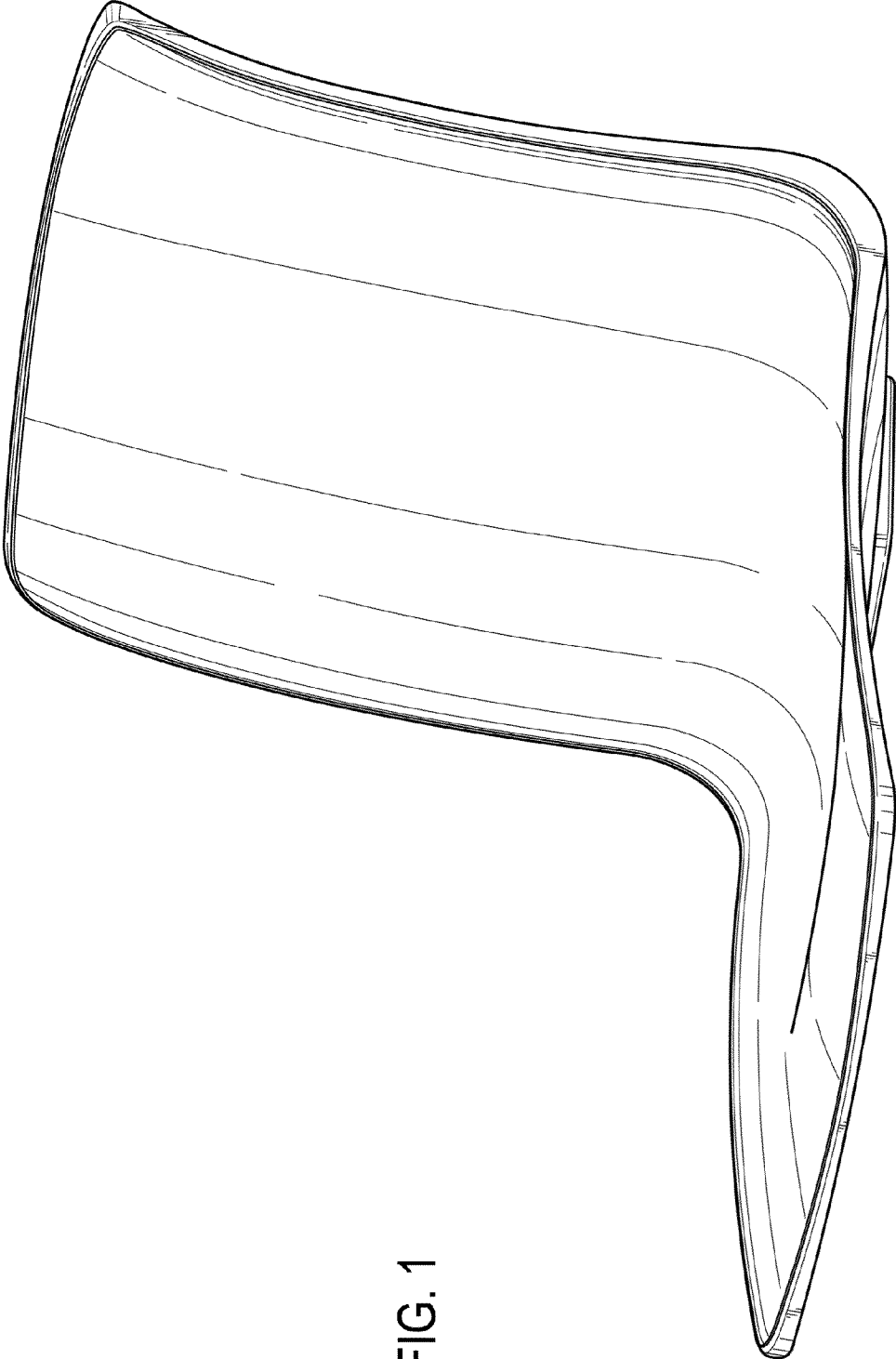

FIG. 1

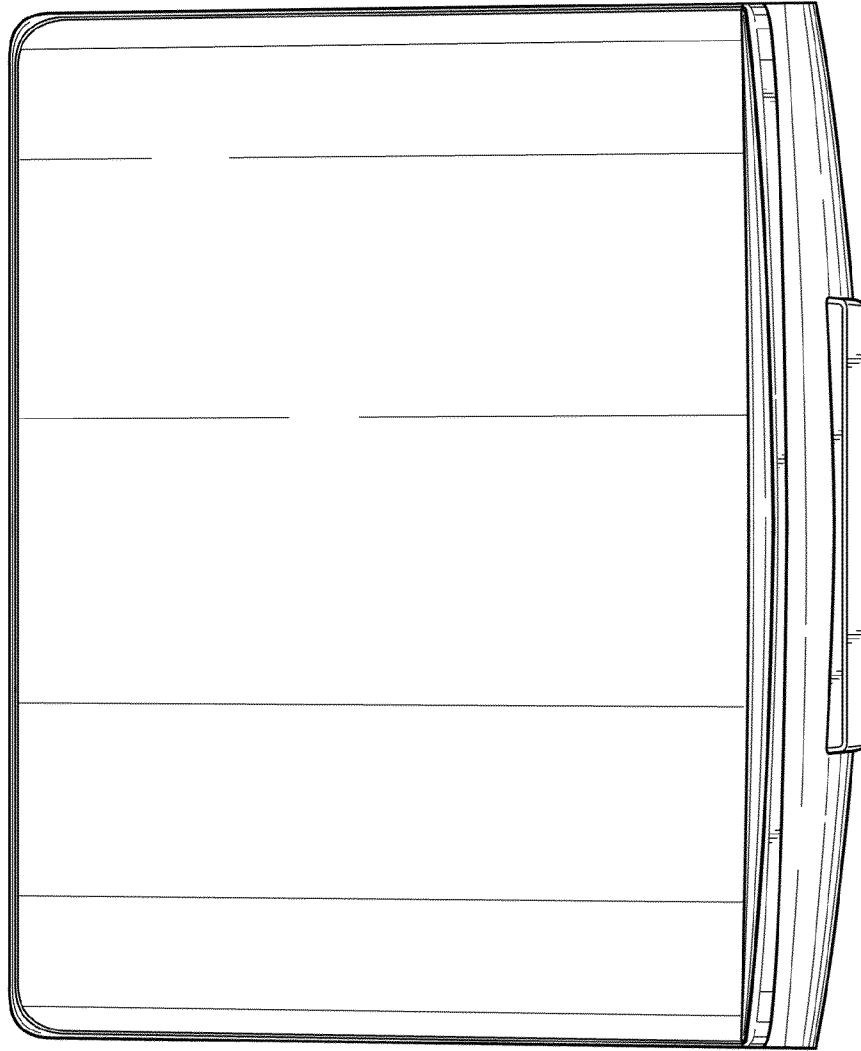

FIG. 2

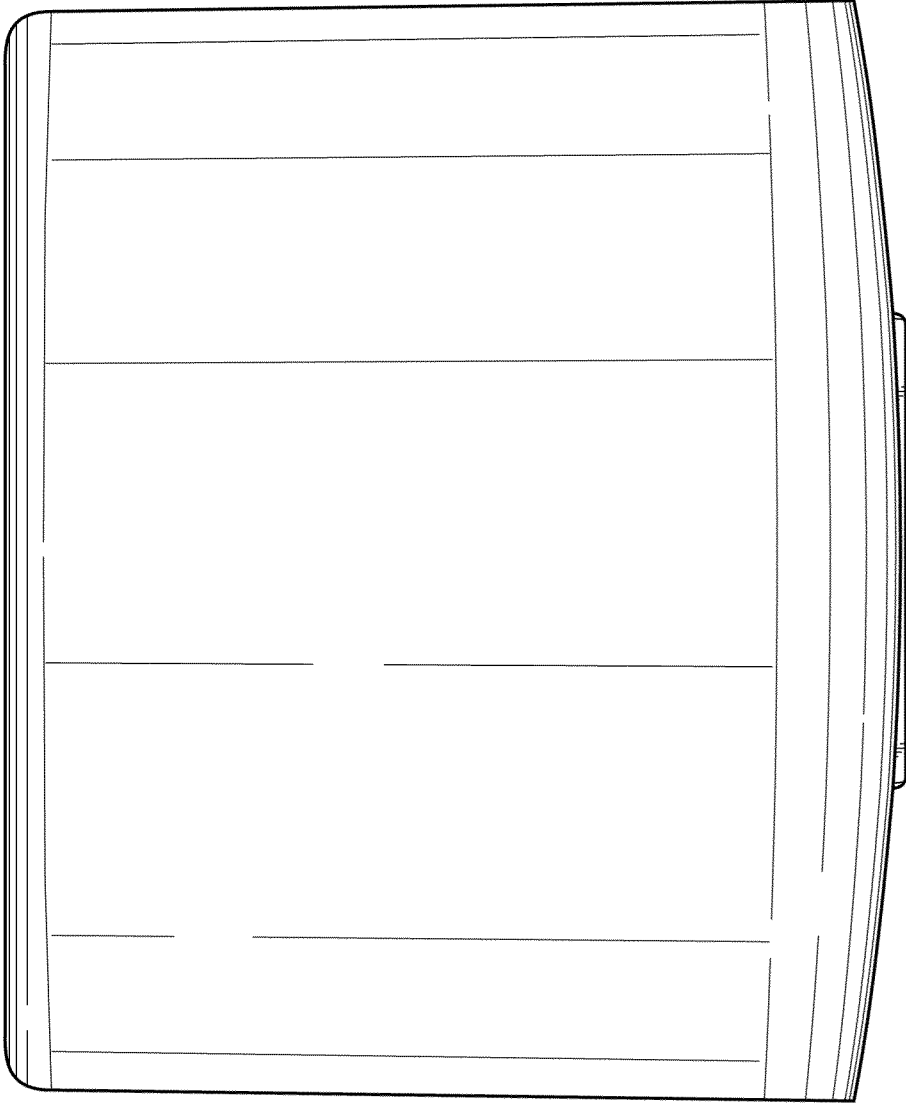

FIG. 3

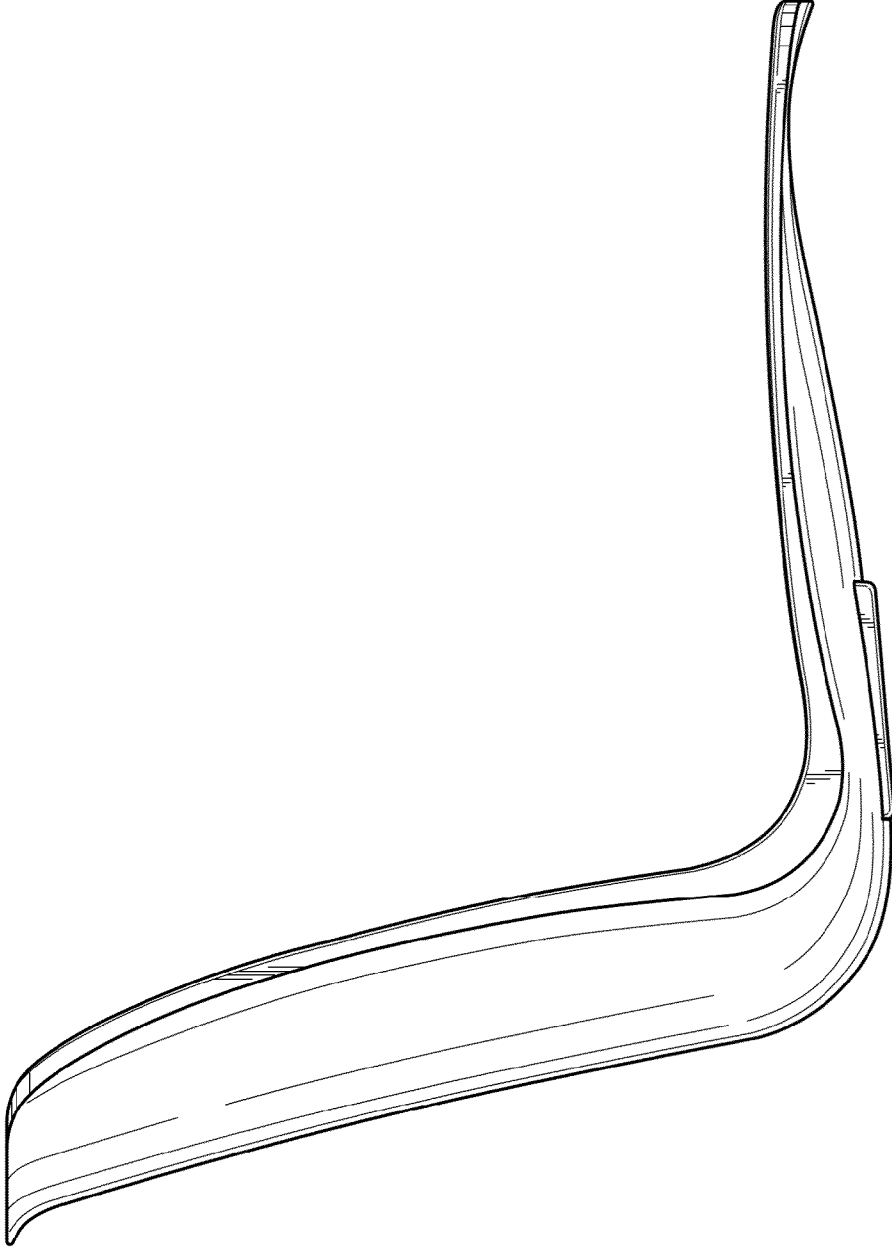

FIG. 4

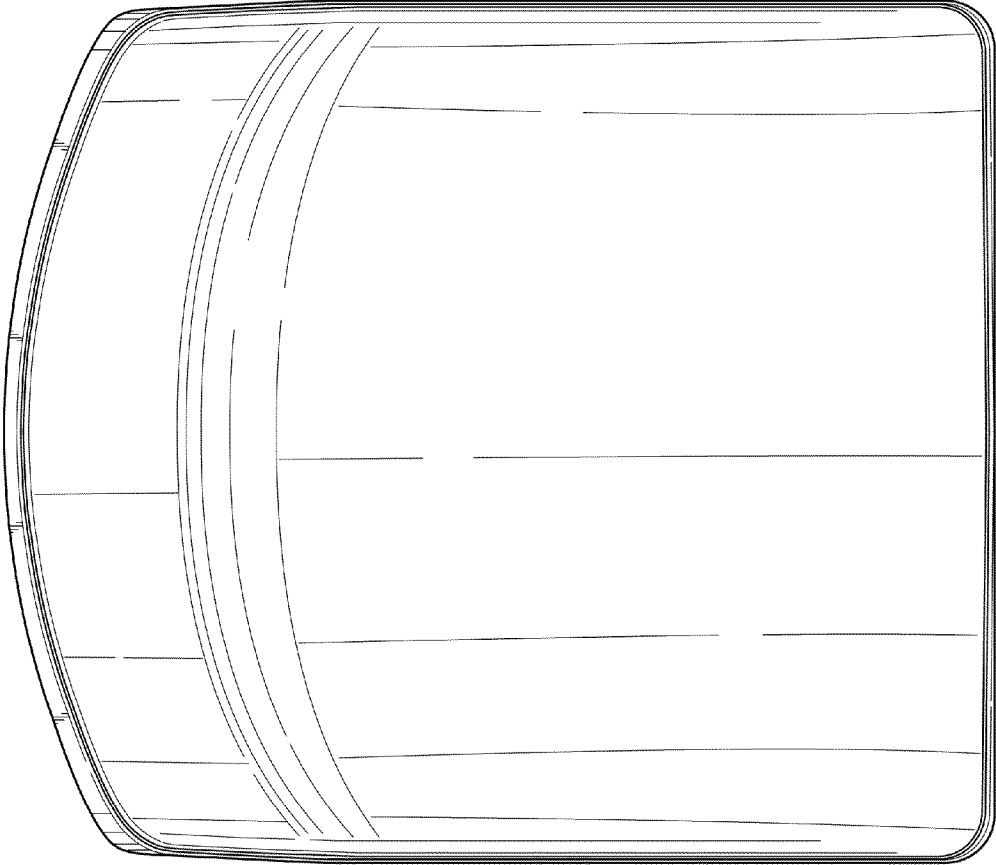

FIG. 5

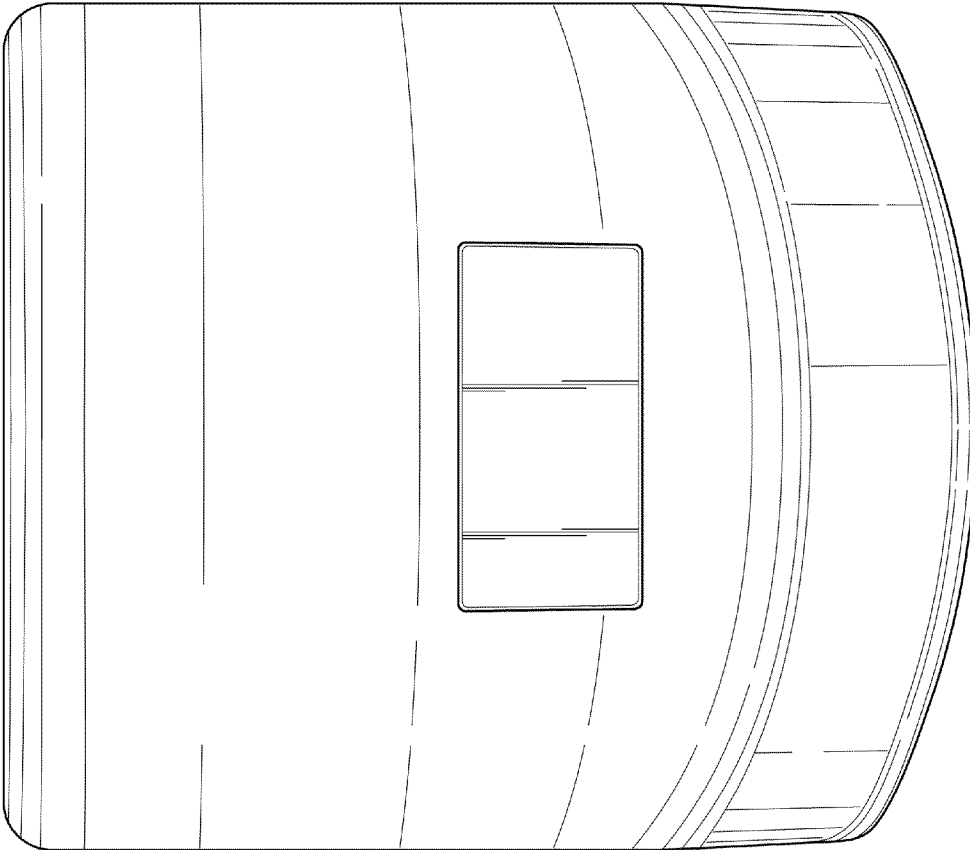

FIG. 6