

(19)  
(12)

(KR)  
(A)

(51) 。 Int. Cl. 7  
G06F 19/00

(11)  
(43)

2003-0042788  
2003 06 02

(21) 10-2001-0073558  
(22) 2001 11 24

(71) 2가 16-6

(72) 3 685-121

6가441 101-604

(74)  
:

(54)

· , (Ir) RF  
, ,  
, ,  
Ir RF POS 1 , POS , POS  
LAN 가 가 , Ir RF POS , POS  
가 , POS , POS  
가 . .

1

, , , RF, ,

1 2 ,

3 4 ,

5 7 POS , 5

7 LAN 6 LAN ,

8 10 POS , 8

10 LAN 9 LAN ,

11 POS ,

12a-12c .

< >

10 : 11 :

12 : 13 :

14 : 15 :

16,36 : 17 :

18 : 19 :

20,32 : 21 : POS

23,31 : 25 : POS

30 : 33 :

34 : 35 :

(Ir) RF , ( POS)

가

가 (card)

가

가

2001-13736

가 가 가  
 가 가 가  
 (Ir) RF 가  
 1  
 가 1  
 가 (Ir) RF 1  
 Ir RF 1  
 1 (10)  
 가 (size) (handy - type) (12)  
 (11) (12) (10)  
 (10) (11) (11) (Ir) (10)  
 (10) RF (10) 1 LCD (15), (power) (ON)/ (OFF)' (13), (14)가 (10) 2  
 2 (10) (12),  
 가 POS (11) (11)  
 (30) (Ir) (112) , RF (111) . 2 (10) ,  
 (30) (POWER) , (20), (clear) (RESET)  
 (13), (12) (11)  
 (18) (15) (13)  
 , 2 (10) (19)  
 1 (18) (17) (16) 1

(10)

3 1 (10) (10) 3 (30)

) (10) (32) (31)

(32) (32) (37)가 (10) (10) (30) 3

(30) (30) (35) (30)

4

4 (30) (10)

(31) (10) (32) (31) RF (3

11) Ir (312) (30) POS LAN I/F(341)

I/F(342) (33) , POS (34) LAN I/F(341)

(10) (30)

POS(Point Of Sales) POS (10) (10)

POS (30) (10) (30)

(30)가 LAN , LAN

5 POS(Point Of Sales) (10) RF 5

(10) (13) (10)

(10) (15) 12a (12a) ,

(13) (13) (17) (15) 12a (10)

'1' (13) '1' (17) (15) 12a (10)

(Ir) , RF RF

(10) RF

(11) Ir (112) (111) , RF (Ir) RF 가 Ir (18)

(112) RF (111) (10) (17) 가 RF (111) (17) (15)

12a (10) 가 POS(21)가 (23)가 가 POS(21) POS R

F (10) 가 POS(21) (23)가 가 (10) (13)

(23) (23) (18) (11) POS(21)

(13) (23) POS(21) (23)가 Ir (112) Ir (10) (13)

(18) (23)가 RF (111) RF (10) (13)

(10) 가 POS(21) (23) ,

(time out) (18) POS(21) (23) POS

(25) LAN POS (25) (VAN) / (40,50) / (40,50) POS

가 , POS(21) (10) (60)

'2' / (40,50)



(75) POS(21) (80) / (40,50) POS(21) LAN  
가 , POS(21) (80) 가 / (40,50)  
가  
(13) 가 (10) (17) (13) (10)  
(10) (15) (15) 가 (10) (12)  
(18) (15) (10) (13) 가  
(15) (10) (15) 가  
가 (10) (12) (18) 가  
(10) (70) POS(21)가 (10)  
가 Ir RF 가  
9 LAN (30) (10)  
9 , RF , 가  
8 가 가 (30) 가  
(10) 가 가 (10) (10) (20)가  
(30) (32) (10) (30) RF Ir (30)  
(30) (30) (31) (10) 가 RF R  
F (311) (31) (10) Ir (312) (10) POS(21)  
. POS(21) (30) LAN (30) (33) I/F(341) (40,50)  
. POS(21) (80) POS(21) (30) / (40,50)  
POS(21) (35) PO  
S(21)가 (30)  
10 POS(21) (30) 가 LAN (30)가 I/F(342)  
POS(21) POS(21) LAN 9 , P  
OS(21) (30) LAN LAN 가  
, 11 POS  
(CAT)(70)가  
(10)  
(10) (13) (10) Ir RF  
(10) , RF , (10) (12)  
(10) (10) (11) 가  
(12) (18) (10) (70)가  
(10) (10) (18) (70) (75)  
(10) (13) (10) (70) 가 Ir, RF (75)  
가 (70) (70) / (40,50) / (40,50)  
75) 0) 가 (70)

가 , , RF , POS , LAN 가

(57)

1.

, ; ; ; ;

1

가

2.

1

3.

2

(lr)

lr

4.

2

RF

RF

5.

3

4

, RF

lr

RF

가

6.

1

7.

1

6

1 8. , , ' (OFF)' (time out) 가 ,

1 9. , ,

9 10. , 가 ,

10 11. , , (Ir) RF Ir RF

10 12. , ,

12 13. , , LAN I/F , LAN I/F

14 14. , 가 , Ir (Ir) RF , RF 1 ;

14 15. , Ir RF ,

14 16. , Ir RF , ;

LAN

14 17. ,



Ir RF

LAN

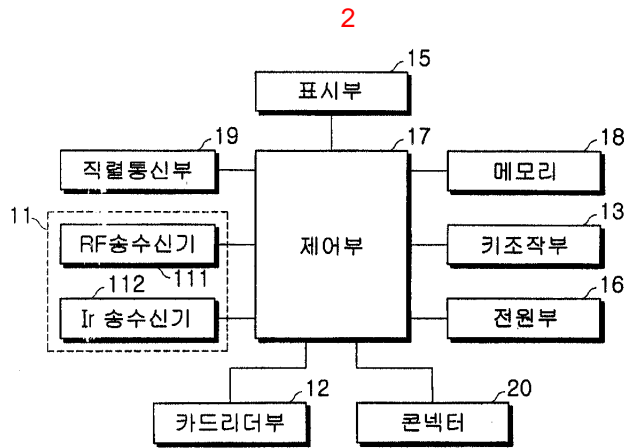
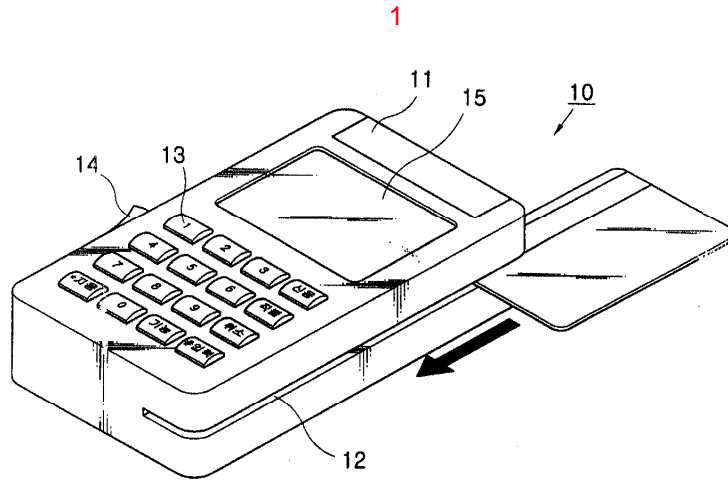

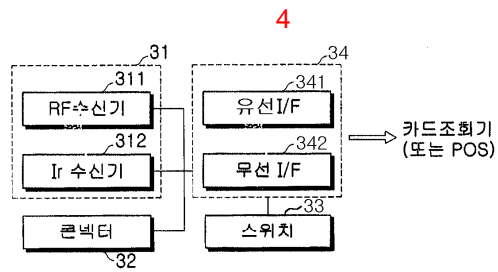
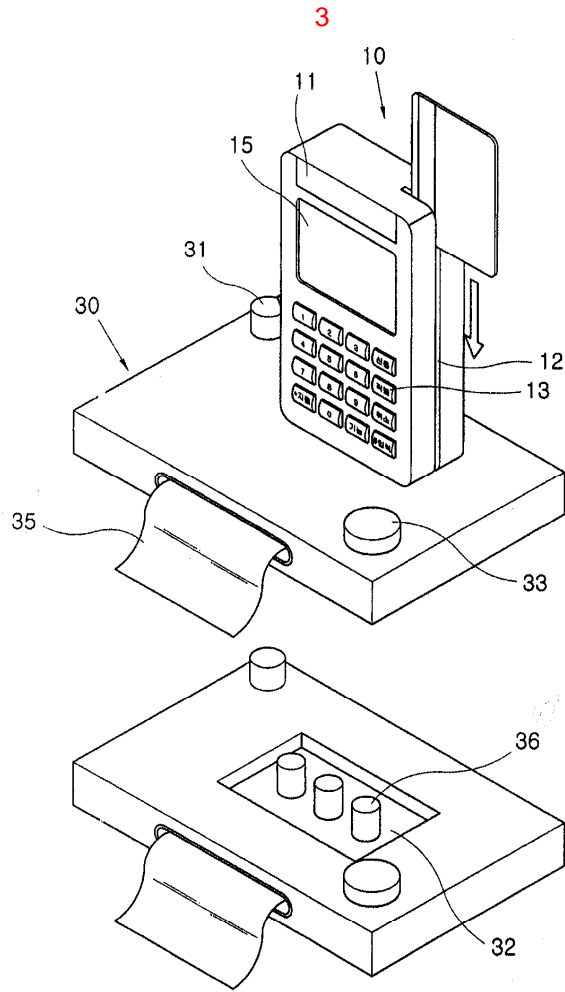

5

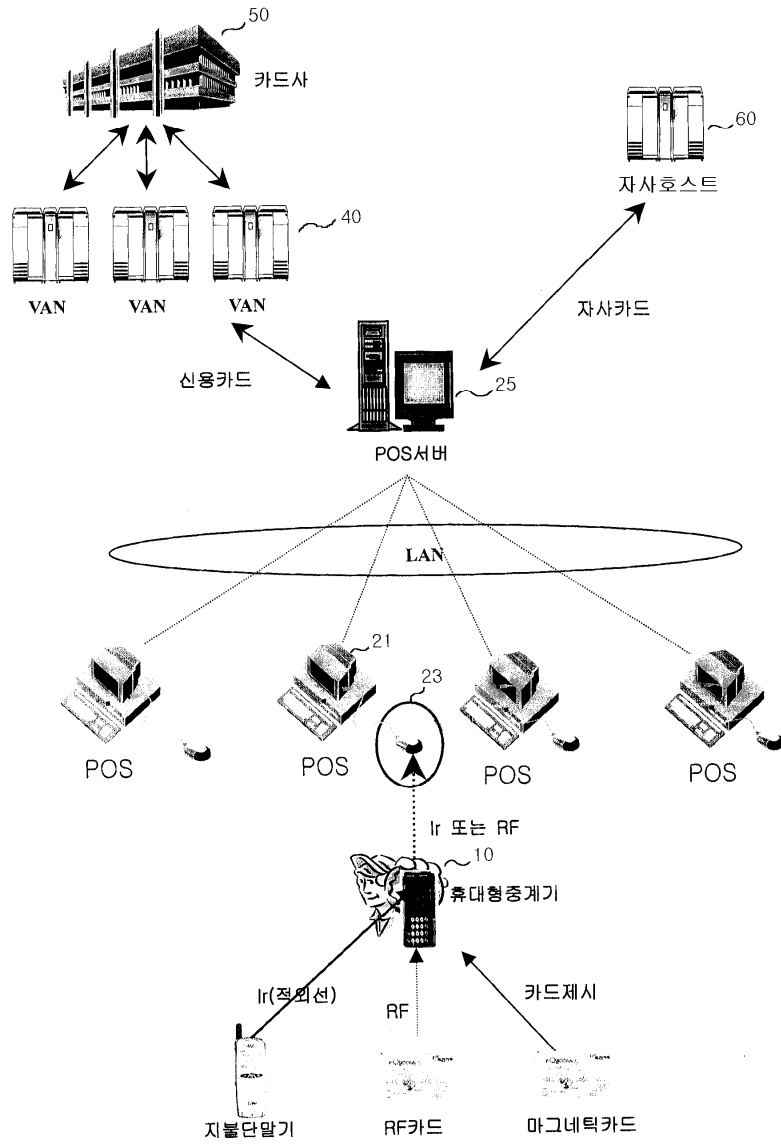

6

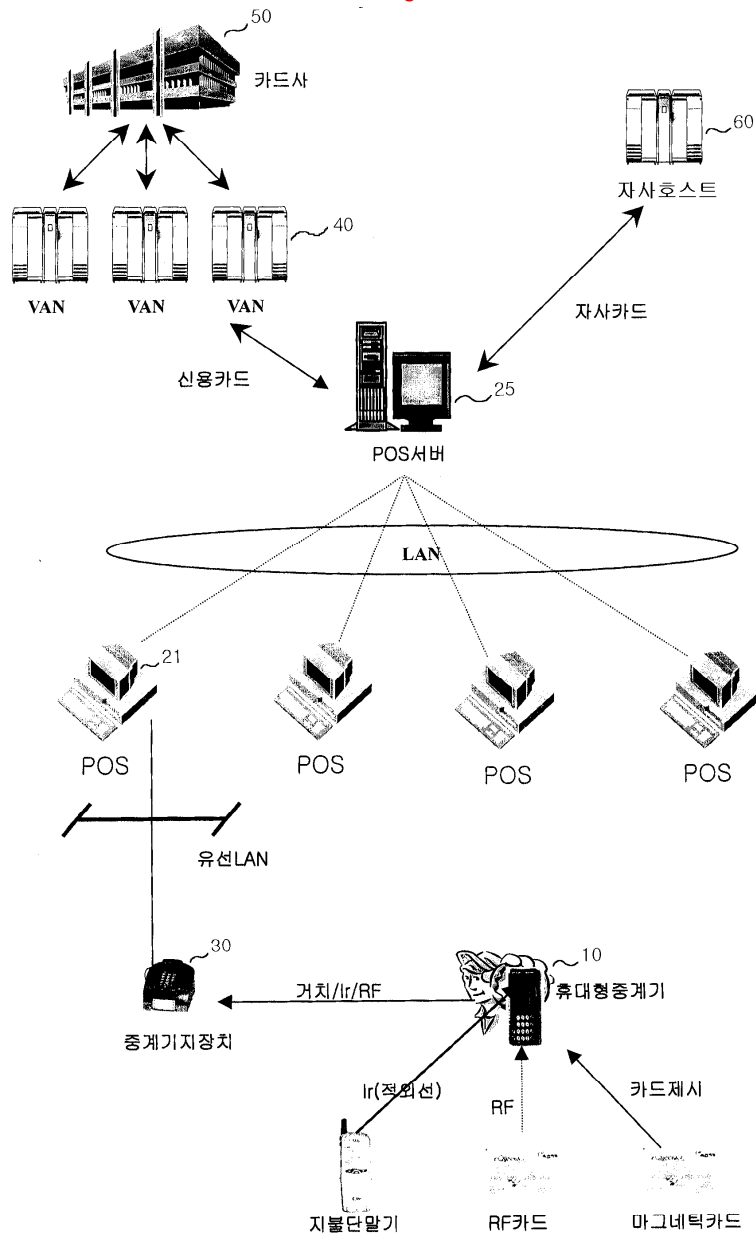

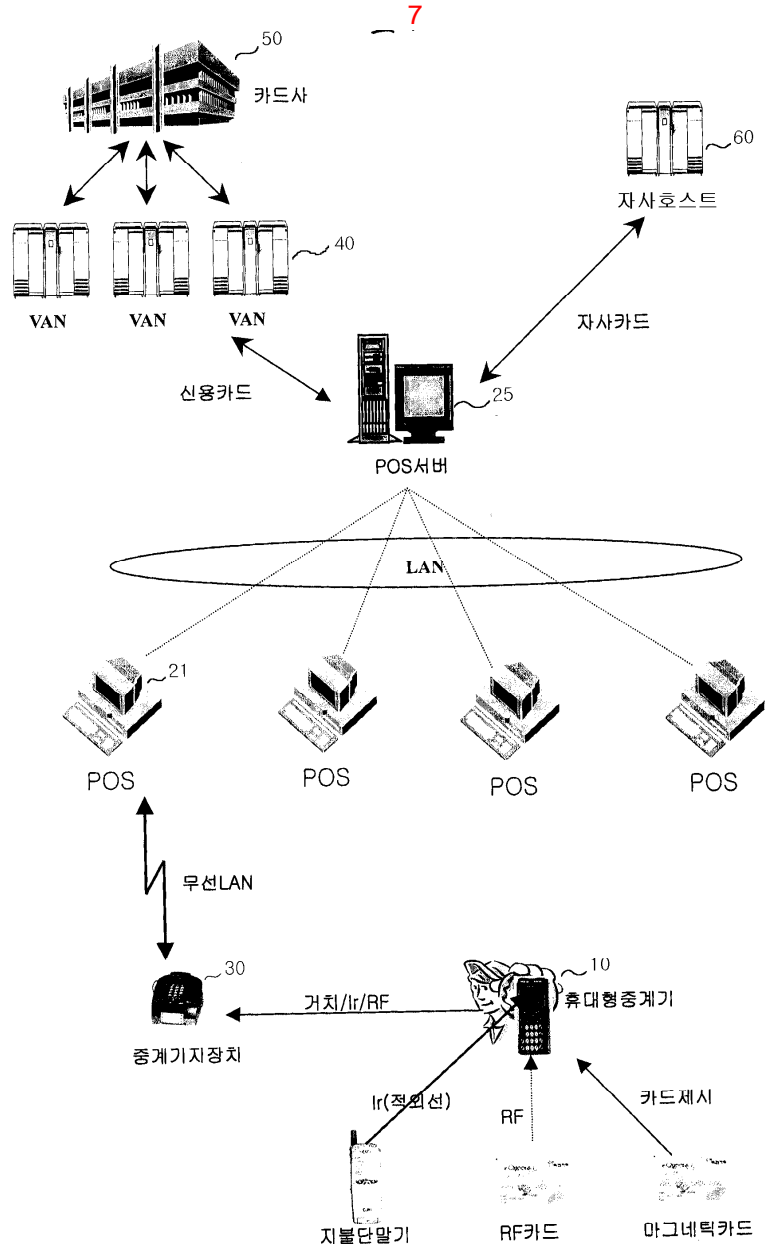

8

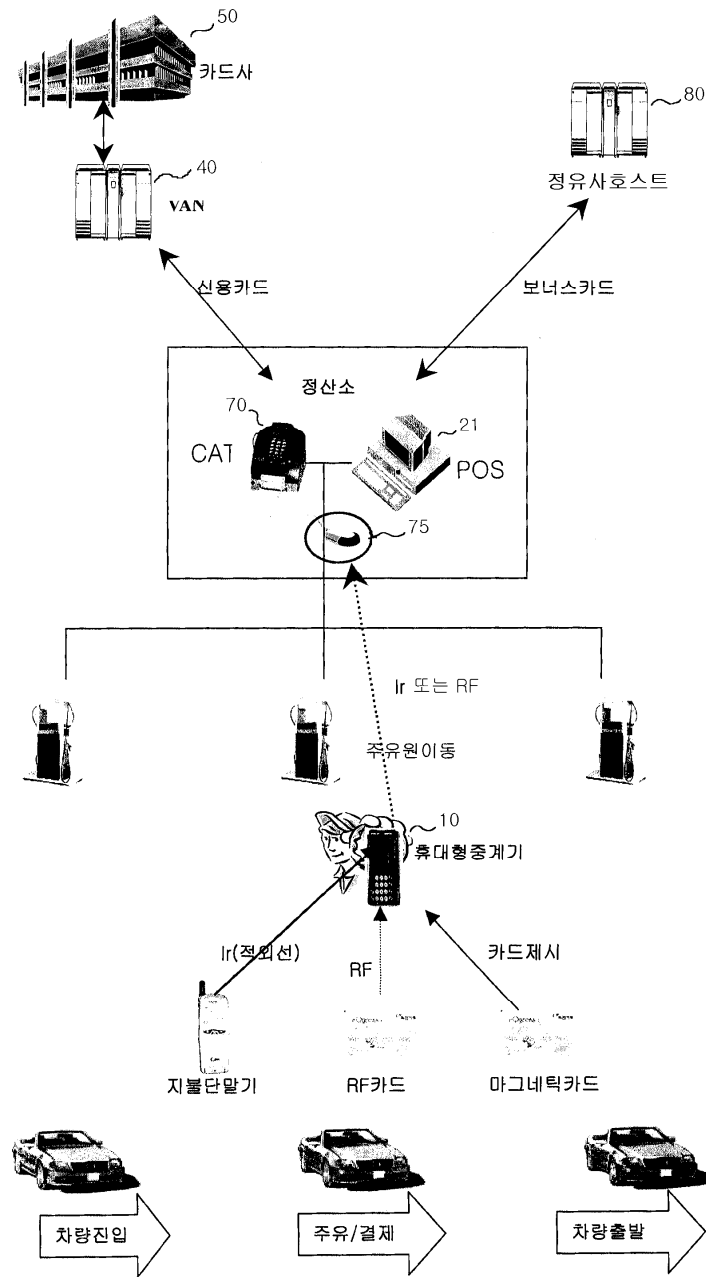

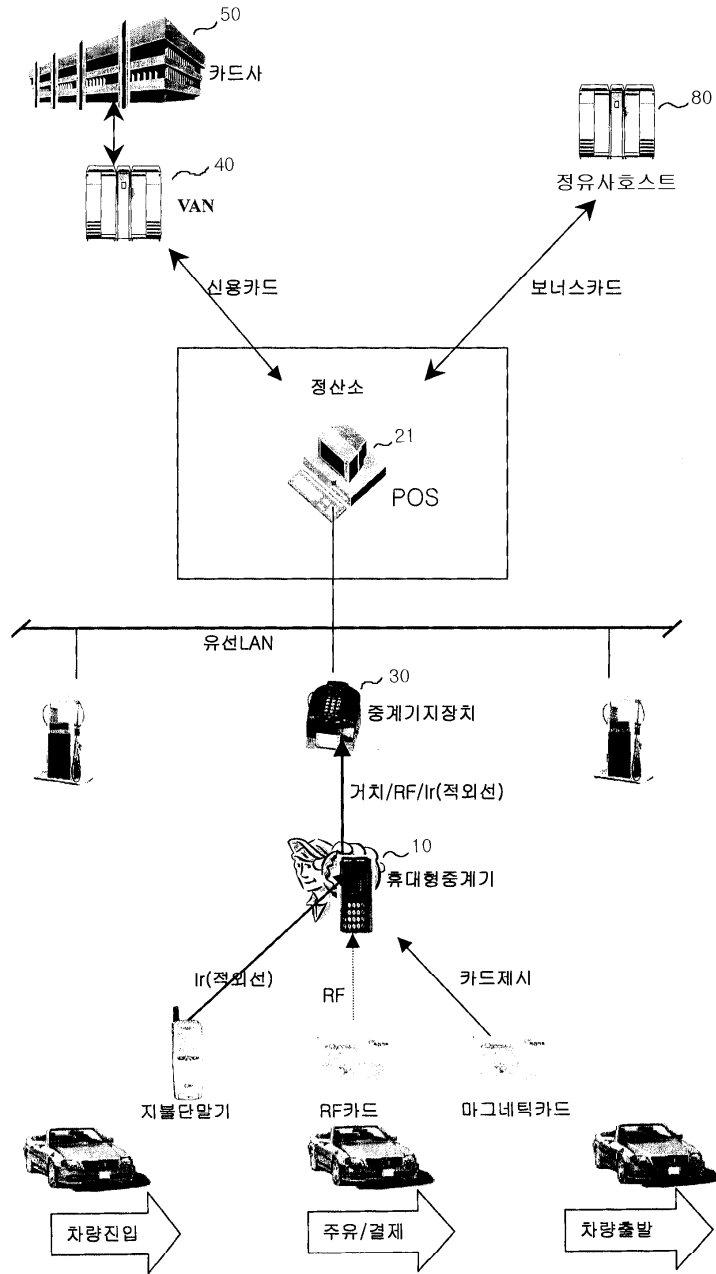

10

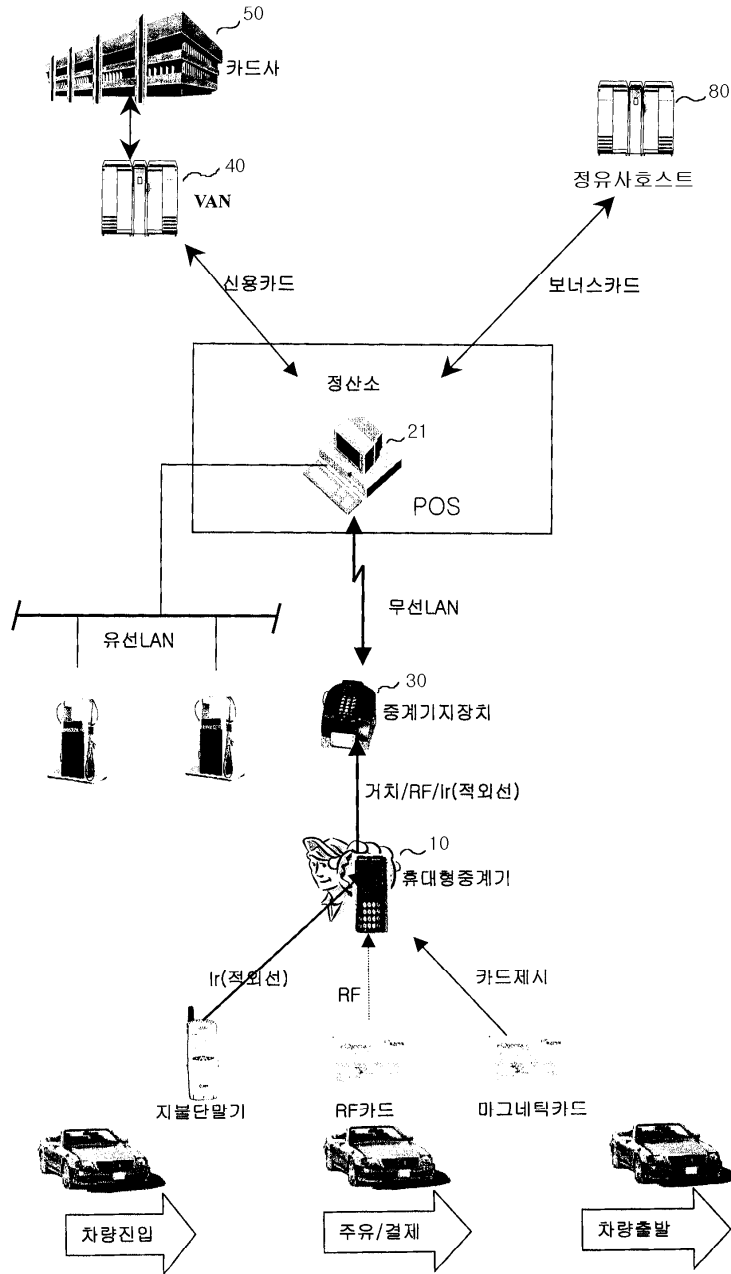



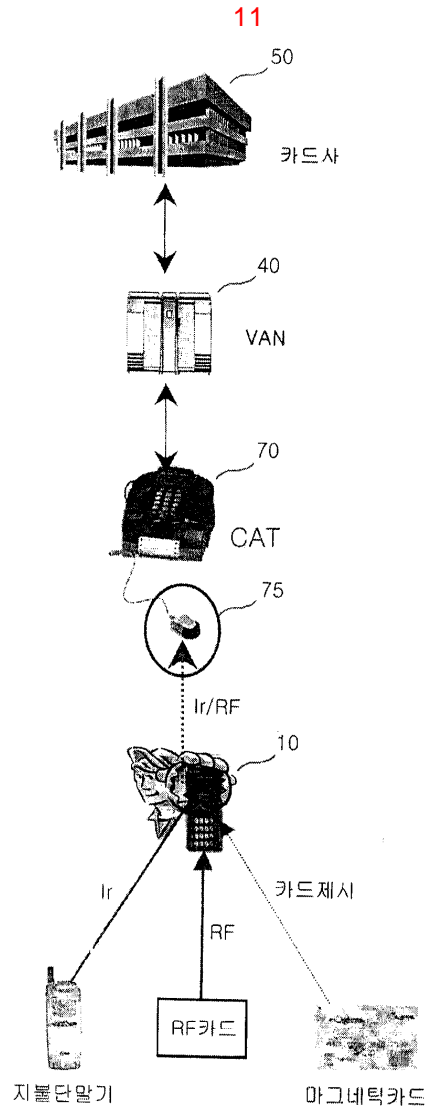

12a

ZOOP  
2001/07/04(수)  
오후 03:30



금액  
999,999,999



신용카드수신대기



XXX 카드  
1234567890123456  
유효기간 : 10/04

12b

ZOOP  
2001/07/04(수)  
오후 03:30



금액  
999,999,999



자사카드수신대기



비밀번호 입력



XXXX 카드  
1234567890123456  
유효기간 : 10/04

12c

ZOOP  
2001/07/04(수)  
오후 03:30



보너스 카드  
수신대기



XXXX 카드  
1234567890123456  
유효기간 : 10/04