



US00D876158S

(12) **United States Design Patent**  
**Coon**

(10) **Patent No.:** **US D876,158 S**

(45) **Date of Patent:** **\*\* Feb. 25, 2020**

(54) **BEVERAGE CONTAINER INSERT**

(71) Applicant: **Dylan Coon**, Lehi, UT (US)

(72) Inventor: **Dylan Coon**, Lehi, UT (US)

(\*\*) Term: **15 Years**

(21) Appl. No.: **29/711,065**

(22) Filed: **Oct. 28, 2019**

D469,664 S	2/2003	Marks	
D478,511 S	8/2003	Reynolds	
D490,652 S	6/2004	Xiang	
D505,831 S	6/2005	Liu	
D526,026 S *	8/2006	Watanabe	..... D21/324
D536,925 S *	2/2007	Macler	..... D7/387
D560,097 S	1/2008	Shen	
D560,545 S *	1/2008	Schneider	..... D11/90

(Continued)

**Related U.S. Application Data**

(63) Continuation-in-part of application No. 29/681,251, filed on Feb. 22, 2019, which is a continuation-in-part of application No. 29/674,716, filed on Dec. 24, 2018.

(51) **LOC (12) Cl.** ..... **07-99**

(52) **U.S. Cl.**

USPC ..... **D7/396.2; D7/507; D11/90**

(58) **Field of Classification Search**

USPC ..... D9/504, 529, 531, 534, 535, 540, 719;  
D7/387, 396.2, 507, 510, 511, 536;  
D11/89, 90

CPC ..... A47G 19/22; A47G 19/2205; A47G  
19/2266; A47J 41/02; B65D 47/066

See application file for complete search history.

(56) **References Cited**

**U.S. PATENT DOCUMENTS**

D160,876 S	11/1950	Mesi	
D232,652 S *	9/1974	Hoffer	..... D11/90
D289,143 S	4/1987	Guillaume	
D320,347 S	10/1991	Lucarelli	
D320,469 S	10/1991	Hoening	
5,150,900 A *	9/1992	Onzo	..... A63F 9/0415 273/146
5,282,541 A	2/1994	Chen	
D362,598 S	9/1995	Kibbe	
D376,979 S	12/1996	Davidson, III	
D455,462 S *	4/2002	Bowling	..... D21/373

**OTHER PUBLICATIONS**

<https://www.mysticwish.co.uk/crystals/crystal-infused-water-bottles-top-step-by-step-guide/> (at least as early as Aug. 2018).

(Continued)

*Primary Examiner* — Lauren R Calve

(74) *Attorney, Agent, or Firm* — Bateman IP

(57) **CLAIM**

I claim the ornamental design for a beverage container insert, substantially as shown and described.

**DESCRIPTION**

FIG. 1 is an upper perspective view of beverage container insert showing my new design;

FIG. 2 is a lower perspective view thereof;

FIG. 3 is a side view thereof taken along a corner, the opposing side view being the same;

FIG. 4 is a side view taken along a side surface, the opposing side view being the same;

FIG. 5 is a top view thereof;

FIG. 6 is a bottom view thereof;

FIG. 7 is a perspective view of the beverage container insert in an exploded environmental use; and,

FIG. 8 is a perspective view of the beverage container insert in an assembled environmental use.

The broken lines shown in the drawings depict portions of a beverage container that form no part of the claimed design.

**1 Claim, 4 Drawing Sheets**

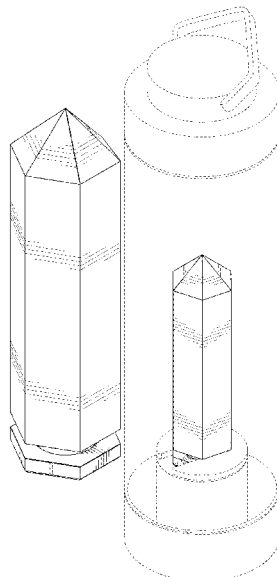

(56)

References Cited

U.S. PATENT DOCUMENTS

D570,648 S 6/2008 Bodum  
 D580,066 S 11/2008 Tilbury  
 D606,661 S 12/2009 Colombo  
 D607,748 S 1/2010 Schmidt  
 D627,602 S 11/2010 Eyal  
 D631,701 S 2/2011 Flick  
 D639,114 S 6/2011 Swinford et al.  
 D639,663 S 6/2011 Llerena  
 D656,823 S 4/2012 Kriegel  
 D683,184 S 5/2013 Lin  
 D687,491 S \* 8/2013 Loebach ..... D19/181  
 D700,014 S 2/2014 Zeanah  
 D709,322 S 7/2014 Ross  
 D709,329 S 7/2014 Ross  
 D720,958 S \* 1/2015 Kehoe ..... D7/396.2  
 D722,113 S 2/2015 Knight  
 D726,498 S 4/2015 Bukhari et al.  
 D726,499 S 4/2015 Kim et al.  
 D727,682 S \* 4/2015 Madvin ..... D7/397  
 9,010,953 B1 4/2015 Wells  
 D729,579 S \* 5/2015 Molayem ..... D7/507  
 D731,244 S 6/2015 Kohl  
 D735,853 S \* 8/2015 Pa ..... D24/129  
 D741,655 S 10/2015 Whelan  
 D742,174 S \* 11/2015 Roth ..... D7/300.2  
 D747,619 S 1/2016 Hampton  
 D747,924 S \* 1/2016 Roth ..... D23/207  
 D753,442 S 4/2016 Weernink  
 D757,375 S 5/2016 Salais

D763,086 S 8/2016 Kalagher  
 D767,339 S 9/2016 Chitayat et al.  
 D770,848 S 11/2016 Wilson et al.  
 D776,483 S 1/2017 Chitayat et al.  
 D777,517 S 1/2017 Anzalone et al.  
 D778,675 S 2/2017 Shi  
 D784,765 S 4/2017 Yao  
 D788,529 S 6/2017 Chitayat et al.  
 D813,678 S \* 3/2018 Kalagher ..... D9/504  
 D820,043 S 6/2018 Leslie-Shattenkirk  
 D829,053 S 9/2018 Leslie-Shattenkirk  
 D832,049 S \* 10/2018 Christener ..... D7/507  
 2008/0251063 A1 \* 10/2008 Palena ..... A47J 36/2416  
 126/263.09  
 2009/0080180 A1 3/2009 Bertken  
 2015/0291312 A1 10/2015 Kalagher

OTHER PUBLICATIONS

U.S. Appl. No. 62/794,760, filed Jan. 21, 2019 (inventor Dylan Coon).  
 Design U.S. Appl. No. 29/672,614, filed Dec. 6, 2018 (inventor Dylan Coon).  
 Design U.S. Appl. No. 29/674,716, filed Dec. 24, 2018 (inventor Dylan Coon).  
 Design U.S. Appl. No. 29/686,285, filed Apr. 3, 2019 (inventor Dylan Coon).  
 Design U.S. Appl. No. 29/681,251, filed Feb. 2, 2019 (inventor Dylan Coon).

\* cited by examiner

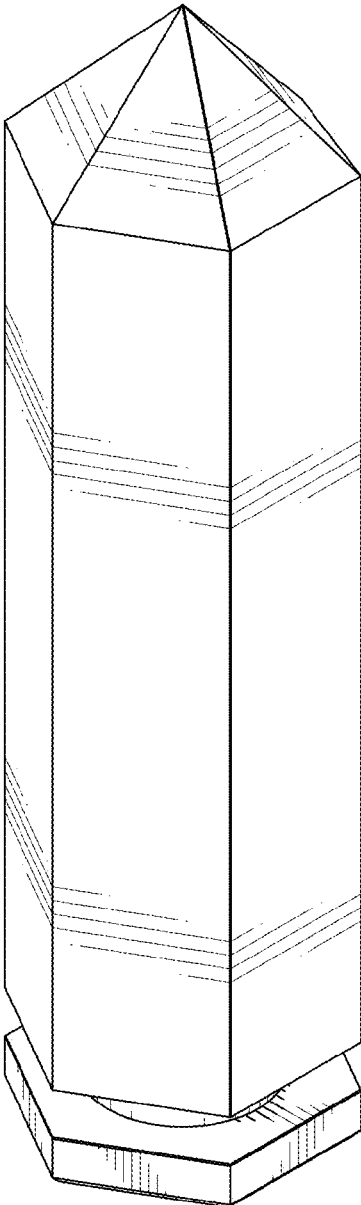

**FIG. 1**

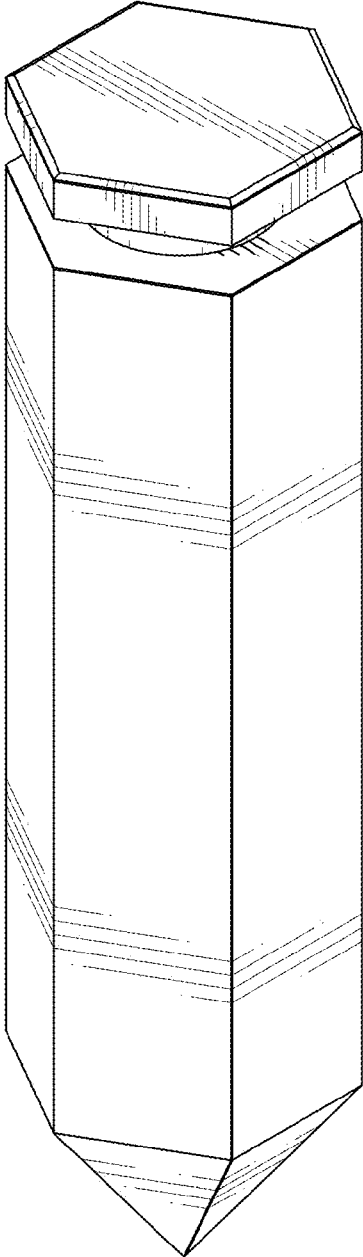

**FIG. 2**

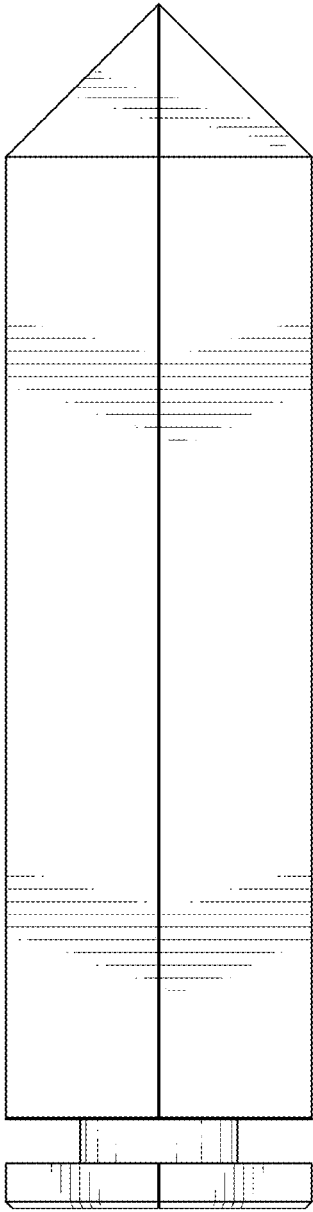

**FIG. 3**

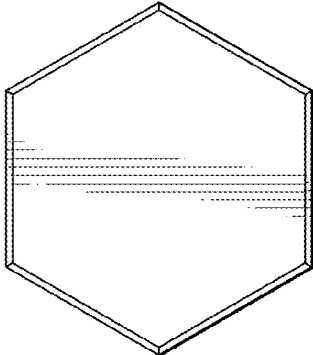

**FIG. 6**

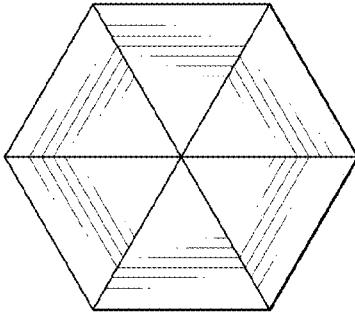

**FIG. 5**

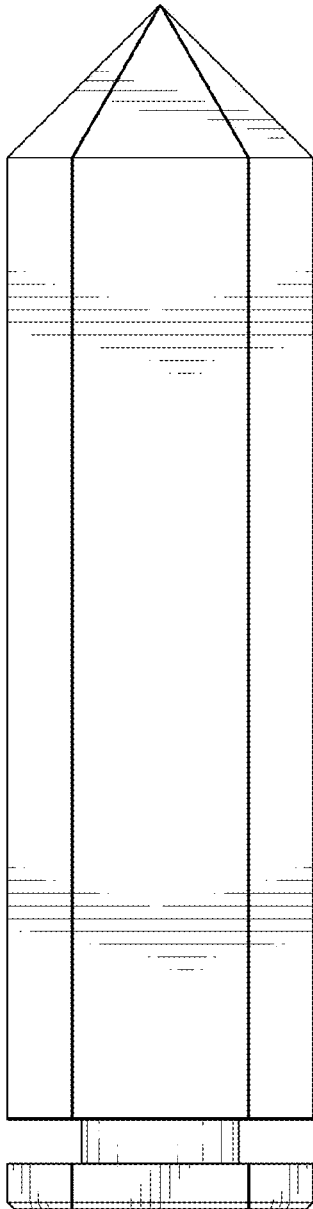

**FIG. 4**

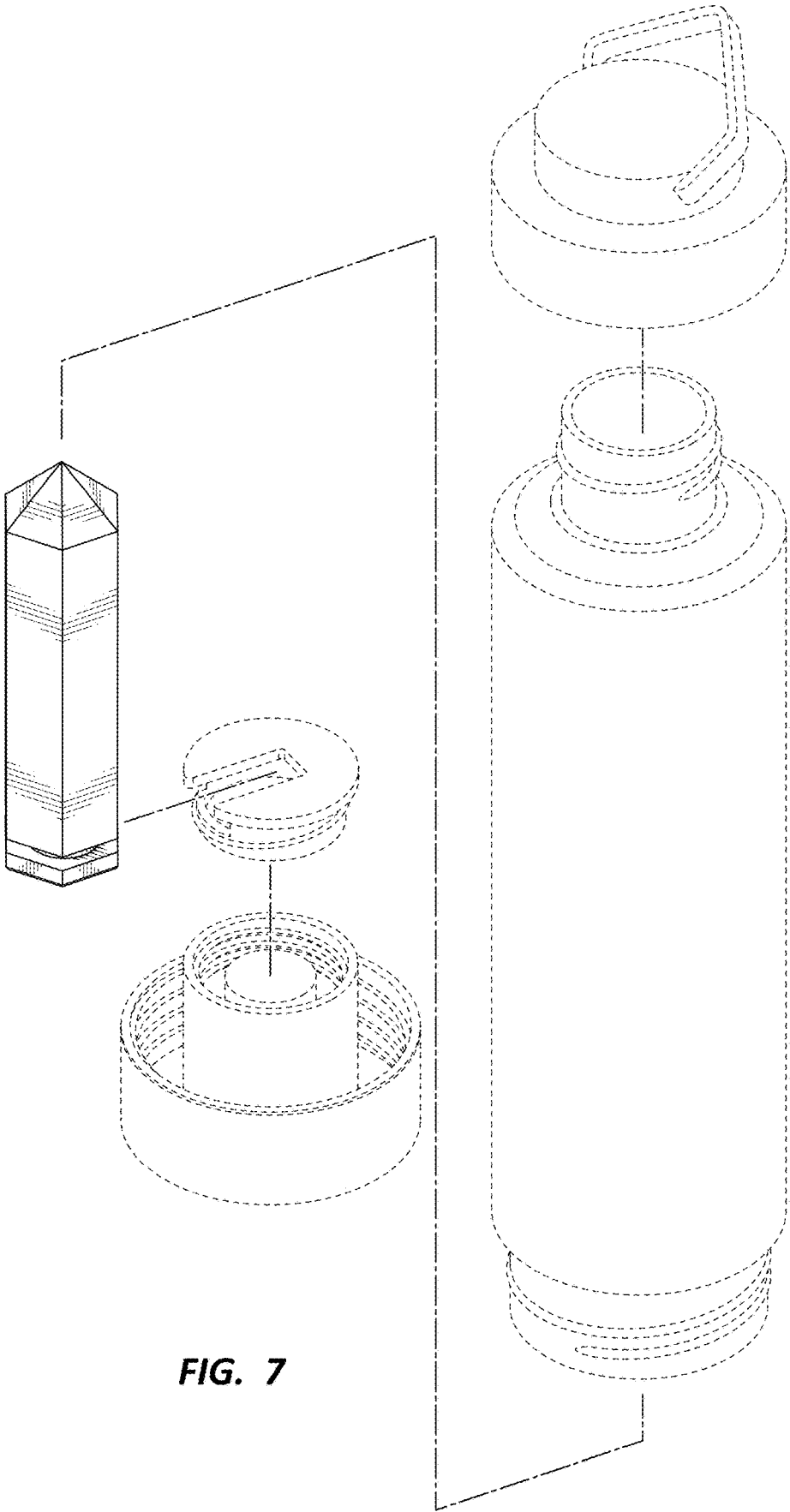

**FIG. 7**

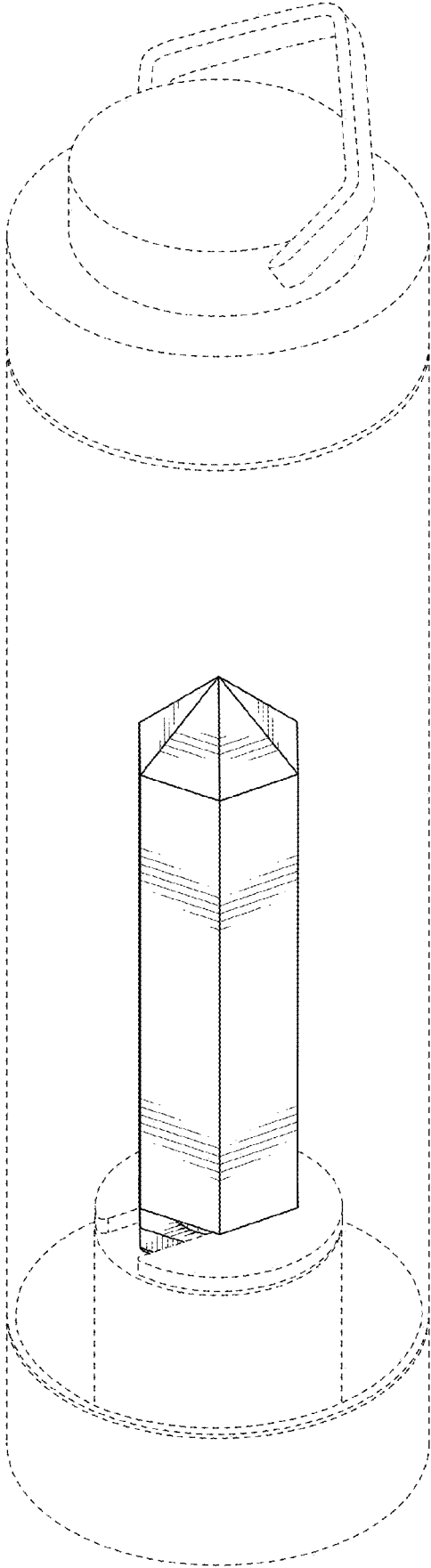

**FIG. 8**