



US00D955961S

(12) **United States Design Patent** (10) **Patent No.:** **US D955,961 S**
Riedel et al. (45) **Date of Patent:** **** Jun. 28, 2022**

(54) **VEHICLE WHEEL**
(71) Applicant: **Daimler AG**, Stuttgart (DE)
(72) Inventors: **Peter Riedel**, Holzgerlingen (DE);
Robert Lesnik, Leonberg (DE);
Thomas Saelzle, Kornwestheim (DE);
Achim-Dietrich Badstuebner, Munich (DE);
Winifredo Camacho, Stuttgart (DE)
(73) Assignee: **Daimler AG**, Stuttgart (DE)
(**) Term: **15 Years**
(21) Appl. No.: **29/795,733**
(22) Filed: **Jun. 21, 2021**

D626,488 S * 11/2010 Yoon D12/211
D668,197 S * 10/2012 Gotschke D12/211
D681,539 S * 5/2013 Zhao D12/211
D819,538 S 6/2018 Badstuebner et al.
D819,539 S 6/2018 Badstuebner et al.
D820,186 S 6/2018 Badstuebner et al.
D820,761 S 6/2018 Badstuebner et al.
D823,221 S 7/2018 Badstuebner et al.
D824,313 S 7/2018 Badstuebner et al.
D845,205 S * 4/2019 Chu D12/211
D847,072 S 4/2019 Badstuebner et al.
D860,912 S * 9/2019 Luo D12/211
D877,017 S * 3/2020 Baum D12/209
D892,705 S * 8/2020 Wittinger D12/211
D895,515 S 9/2020 Badstuebner et al.
D895,516 S 9/2020 Badstuebner et al.
D895,519 S 9/2020 Badstuebner et al.
D895,521 S 9/2020 Badstuebner et al.
D897,256 S * 9/2020 Han D12/209
D906,215 S 12/2020 Badstuebner et al.

(Continued)

Related U.S. Application Data

(62) Division of application No. 35/509,371, filed on Nov. 14, 2019 (U.S. filing date under 35 U.S.C. 384), and having an international filing date of Nov. 14, 2019, now Pat. No. Des. 928,062.
(51) **LOC (13) Cl.** **12-16**
(52) **U.S. Cl.**
USPC **D12/211**
(58) **Field of Classification Search**
USPC D12/204-213; D21/533, 561, 563
CPC B60B 3/02; B60B 3/04; B60B 3/06; B60B 3/10
See application file for complete search history.

FOREIGN PATENT DOCUMENTS

EM 000613419-0005 2/2007
Primary Examiner — Joseph Kukella
(74) *Attorney, Agent, or Firm* — Crowell & Moring LLP

(57) **CLAIM**

The ornamental design for a vehicle wheel, as shown and described.

DESCRIPTION

FIG. 1 is a front view of a vehicle wheel according to the design;
FIG. 2 is a perspective view thereof;
FIG. 3 is a right side view thereof;
FIG. 4 is a left side view thereof;
FIG. 5 is a rear view thereof;
FIG. 6 is a top view thereof; and,
FIG. 7 is a bottom view thereof.

1 Claim, 7 Drawing Sheets

(56) **References Cited**

U.S. PATENT DOCUMENTS

D416,850 S * 11/1999 Cohen D12/211
D466,851 S * 12/2002 Pfeiffer D12/211
D520,931 S * 5/2006 Hieke D12/211
D543,923 S * 6/2007 Hieke D12/211
D556,113 S * 11/2007 Celik D12/211

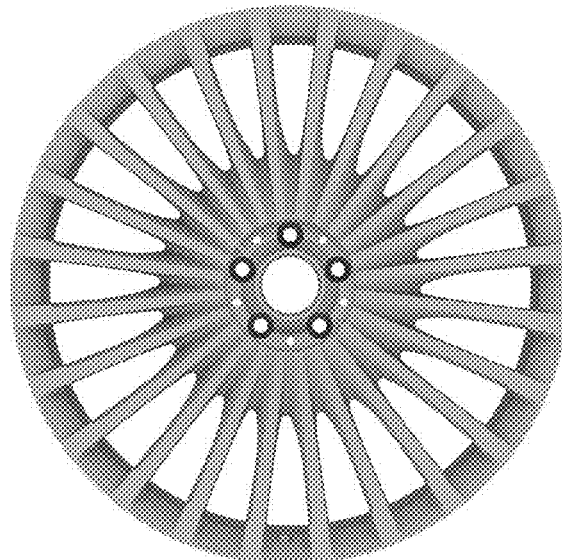

(56)

References Cited

U.S. PATENT DOCUMENTS

D908,579	S	1/2021	Badstuebner et al.	
D941,213	S	* 1/2022	Badstübner	B60B 3/02 D12/209
D944,704	S	* 3/2022	Anscheidt	D12/209
D944,705	S	* 3/2022	Anscheidt	D12/209
D945,342	S	* 3/2022	Sempek	D12/209
D945,346	S	* 3/2022	Abderrazak	D12/209
D947,745	S	* 4/2022	Krause	D12/209

* cited by examiner

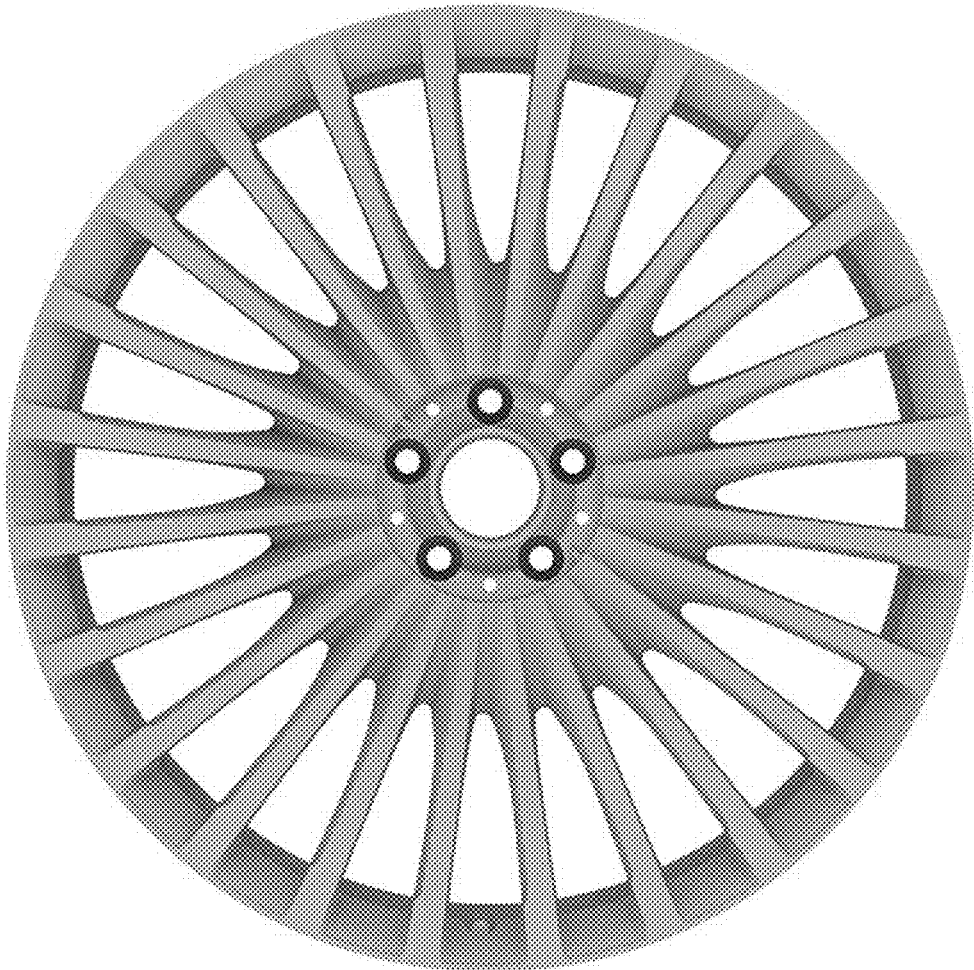

Fig. 1

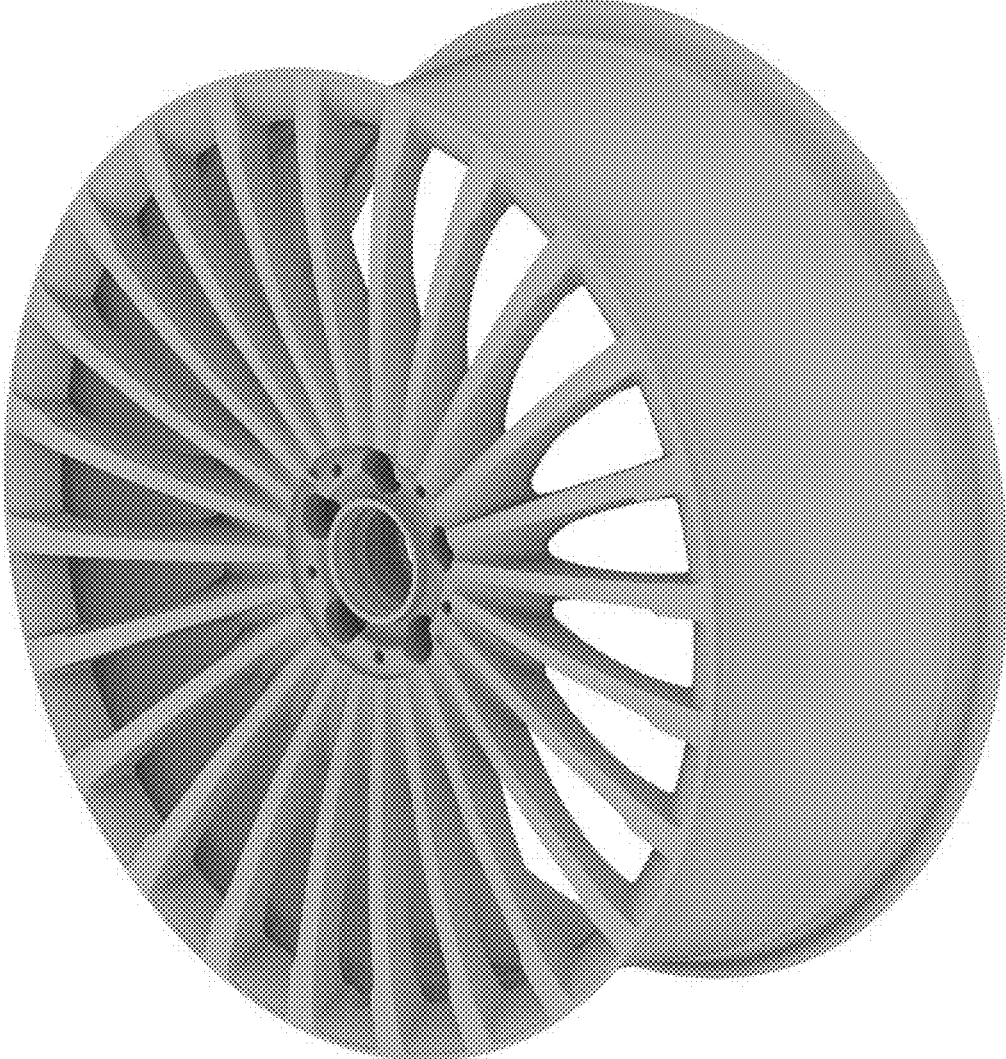

Fig. 2

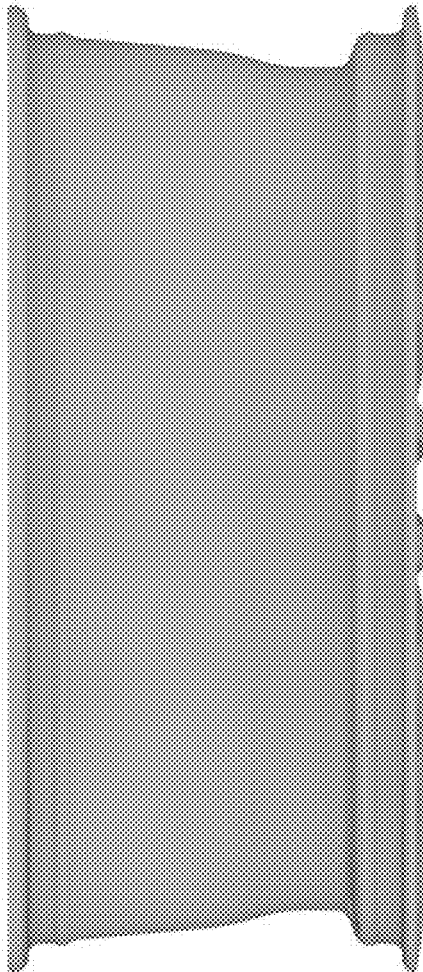

Fig. 3

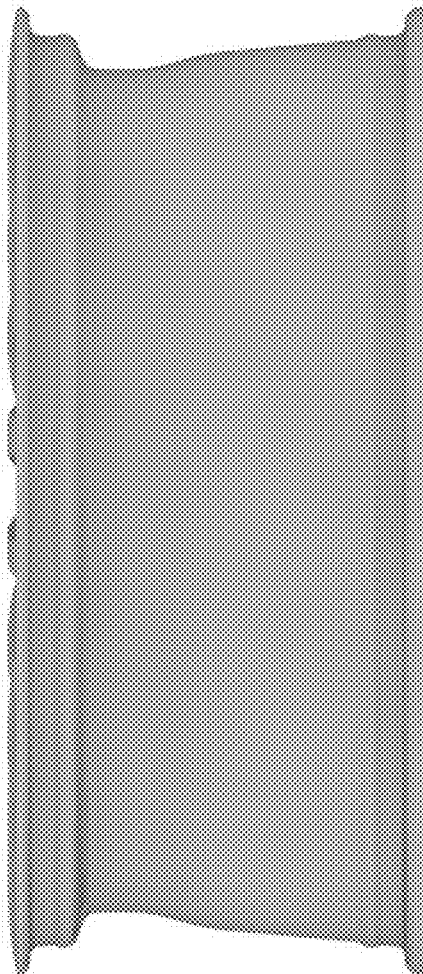

Fig. 4

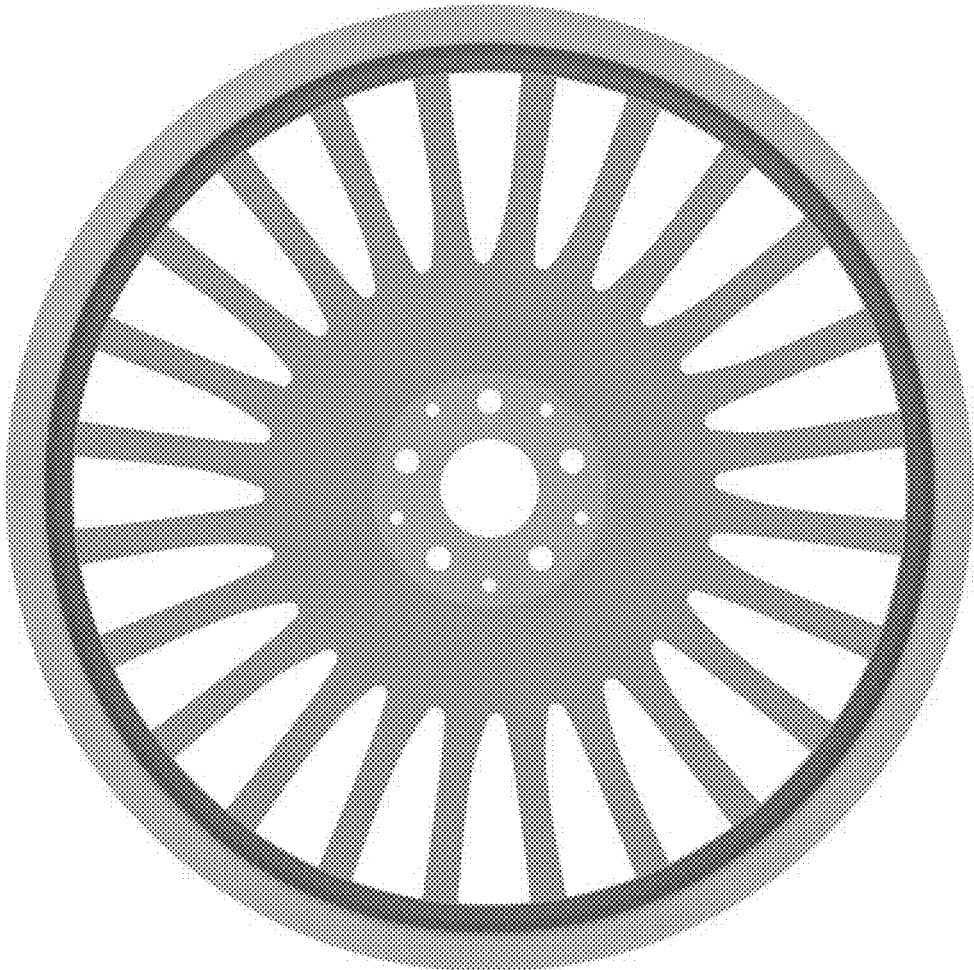

Fig. 5

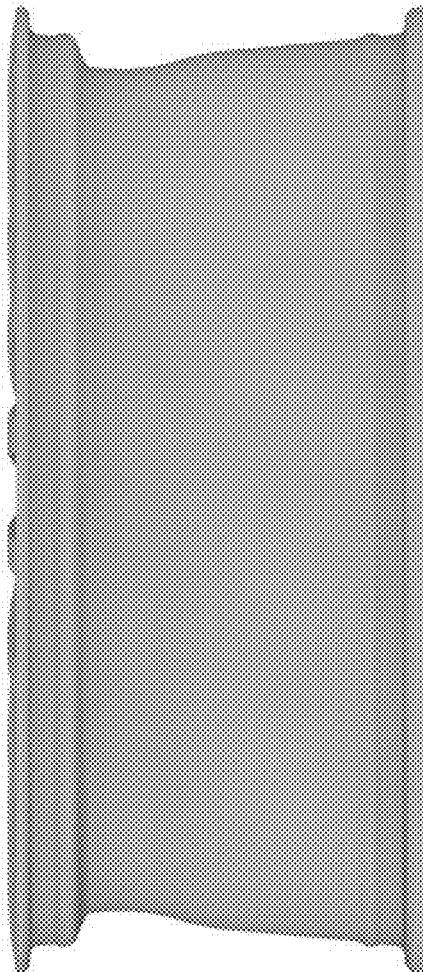

Fig. 6

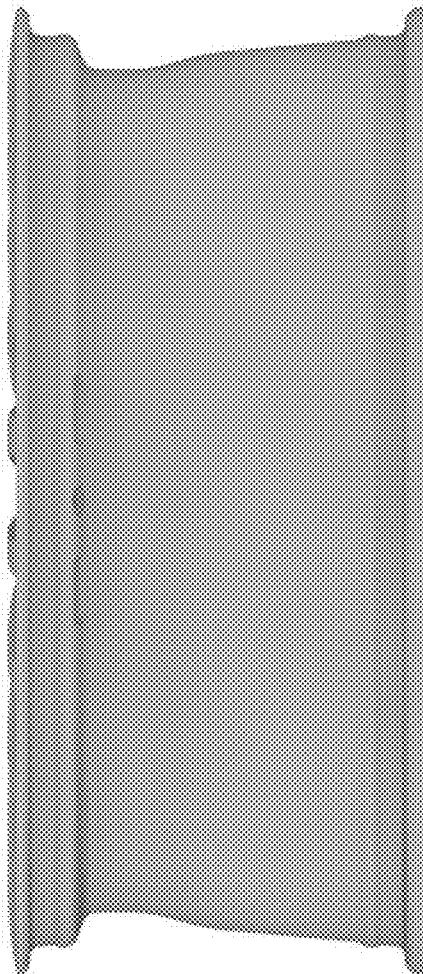

Fig. 7