



US00D472774S

(12) **United States Design Patent**
Pelstring et al.

(10) **Patent No.:** **US D472,774 S**

(45) **Date of Patent:** **** Apr. 8, 2003**

(54) **FOOD CONTAINER WITH MULTIPLE
REMOVABLE STORAGE COMPARTMENTS**

(76) Inventors: **Tammy Espinoza Pelstring**, 127 De La
Costa Ave., Santa Cruz, CA (US)
95060; **Amy Jo Hemmert**, 188 Oak
Creek Blvd., Scotts Valley, CA (US)
95066

(**) Term: **14 Years**

(21) Appl. No.: **29/159,422**

(22) Filed: **Apr. 22, 2002**

(65) **Prior Publication Data**

- (65)
- (51) **LOC (7) Cl.** **07-01**
- (52) **U.S. Cl.** **D7/629; D7/709**
- (58) **Field of Search** **D7/601, 602, 629,**
D7/709; D3/201-206, 273, 276, 283, 284,
295; 190/109, 110; 206/216, 223, 541-550,
549

(56) **References Cited**

U.S. PATENT DOCUMENTS

1,458,679 A * 6/1923 Bishop 206/541 X

- D309,981 S * 8/1990 French et al. D3/295
- 5,390,797 A * 2/1995 Smalley et al. 206/542
- 5,595,302 A * 1/1997 Maydwell et al. 206/541
- 5,671,846 A * 9/1997 Frank 206/541
- 6,112,899 A * 9/2000 Zeringue 206/549 X

* cited by examiner

Primary Examiner—Terry A. Wallace

(57) **CLAIM**

The ornamental design of a food container with multiple removable storage compartments, as shown and described.

DESCRIPTION

FIG. 1 is a perspective front view of a food container, with the lid open, showing our new design;
 FIG. 2 is a perspective front view thereof with lid closed;
 FIG. 3 is a frontal elevation view thereof with lid closed;
 FIG. 4 is a frontal elevation view thereof with lid open;
 FIG. 5 is a left elevation view thereof with lid open;
 FIG. 6 is a right elevation view thereof with lid open;
 FIG. 7 is a top plan view thereof with lid open; and,
 FIG. 8 is a bottom plan view thereof with lid open.

1 Claim, 8 Drawing Sheets

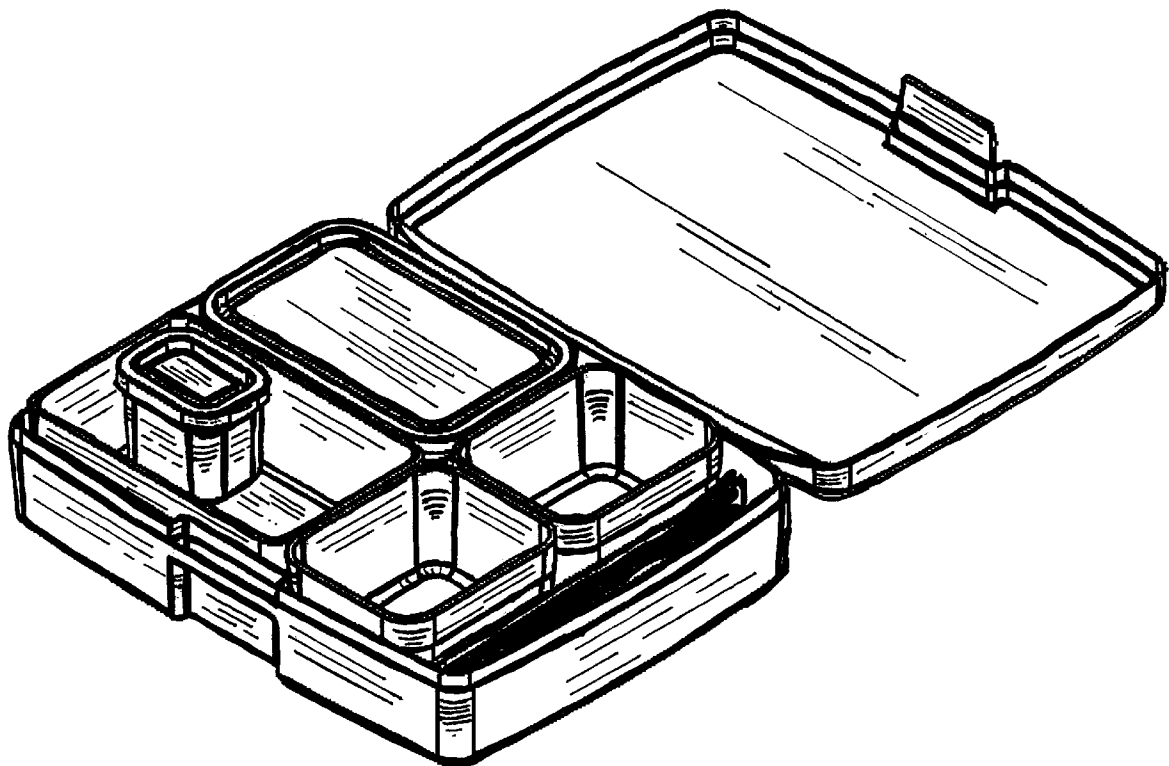

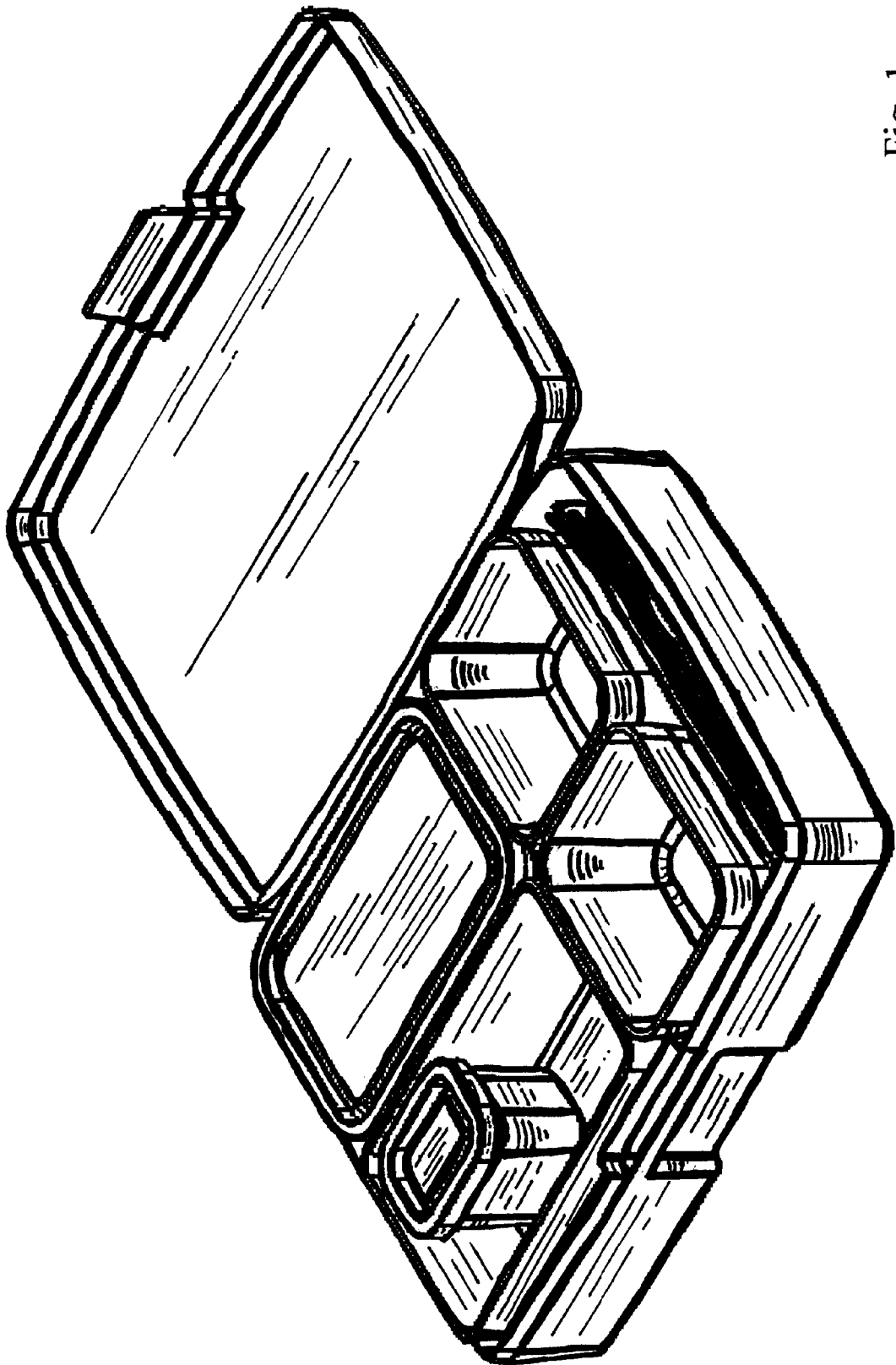

Fig. 1

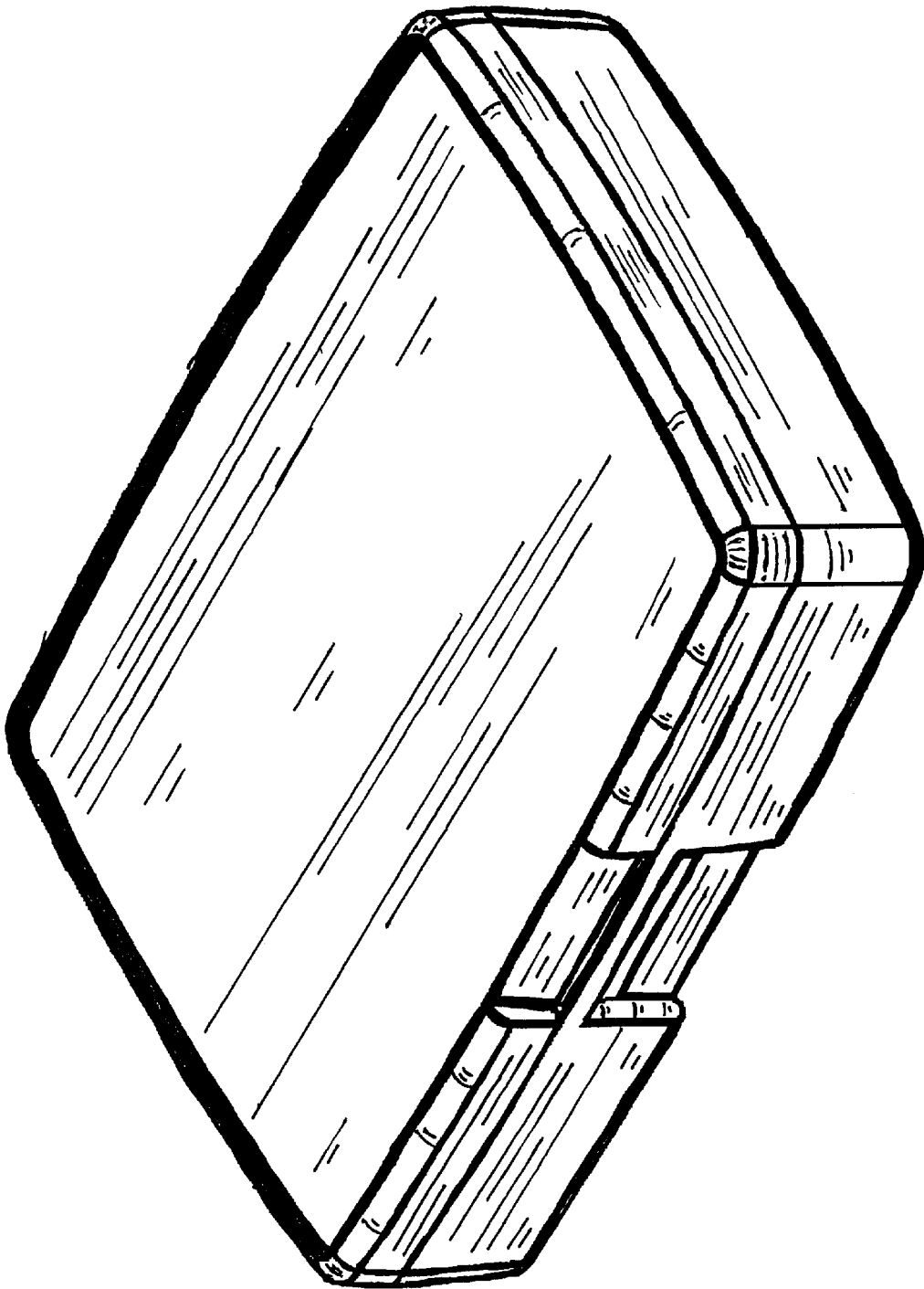

Fig. 2

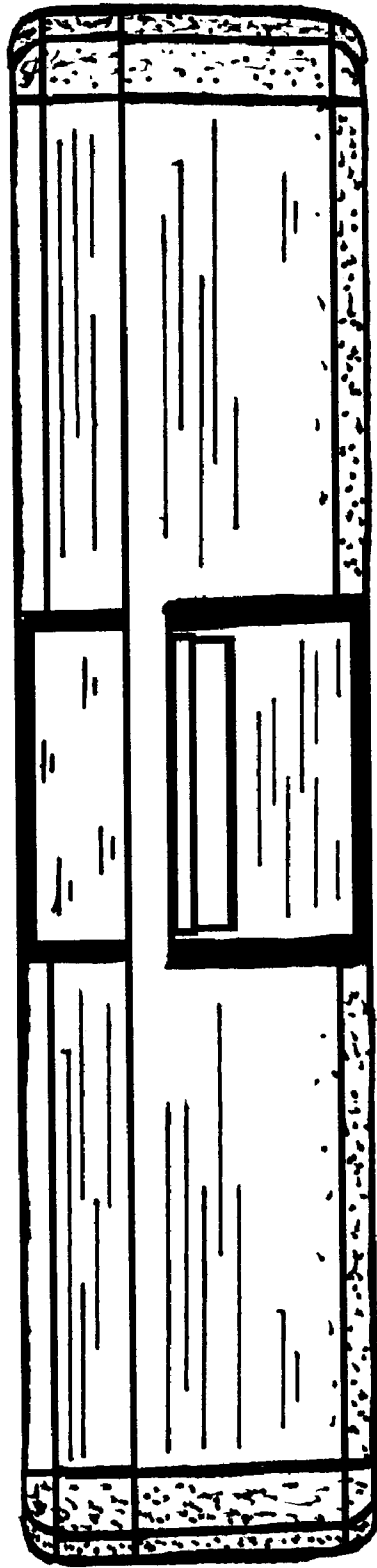
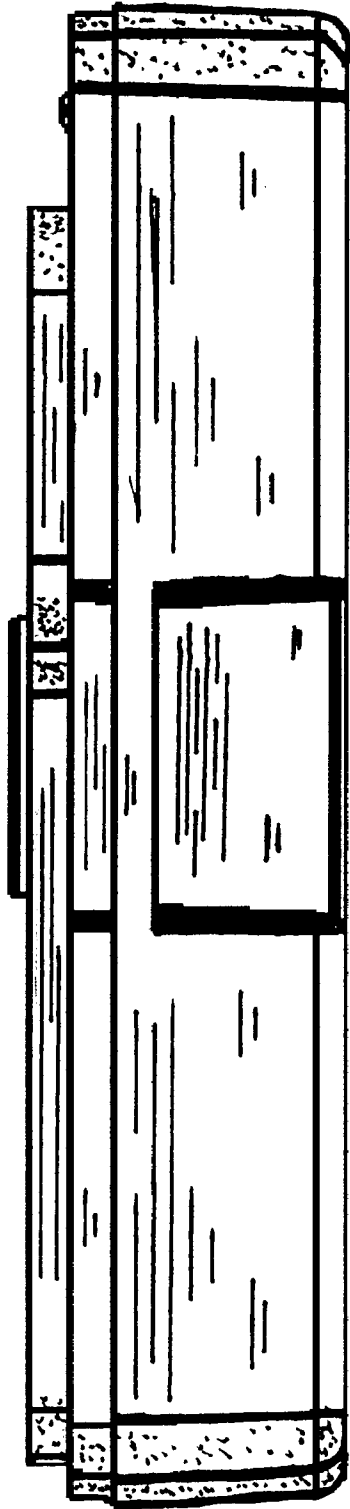

Fig. 3

Fig. 4



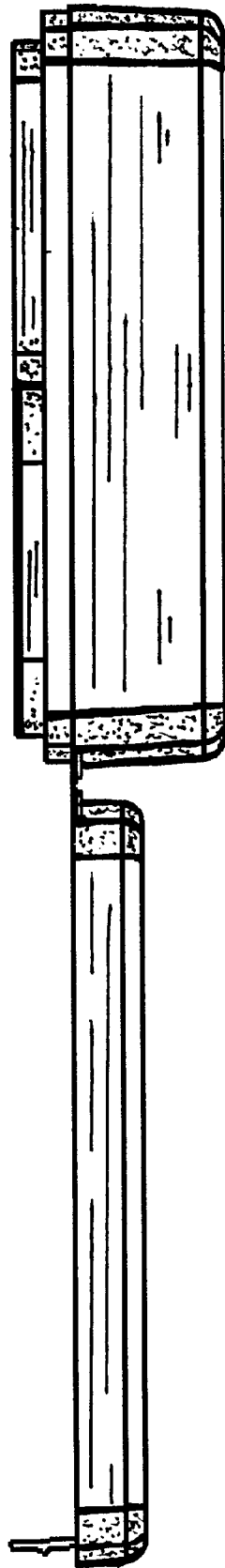

Fig. 5

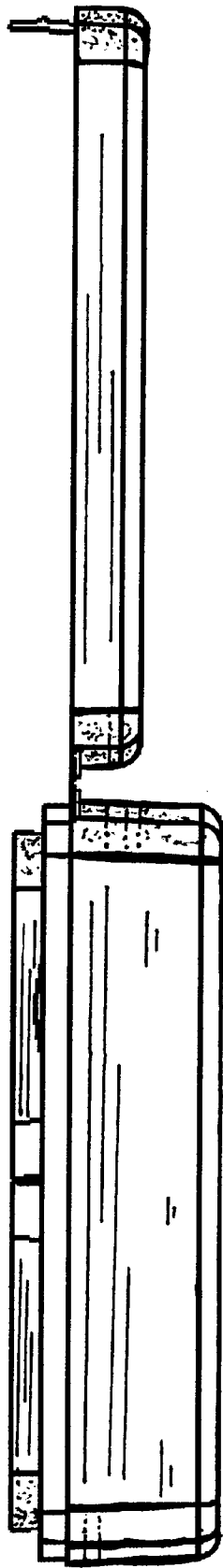

Fig. 6

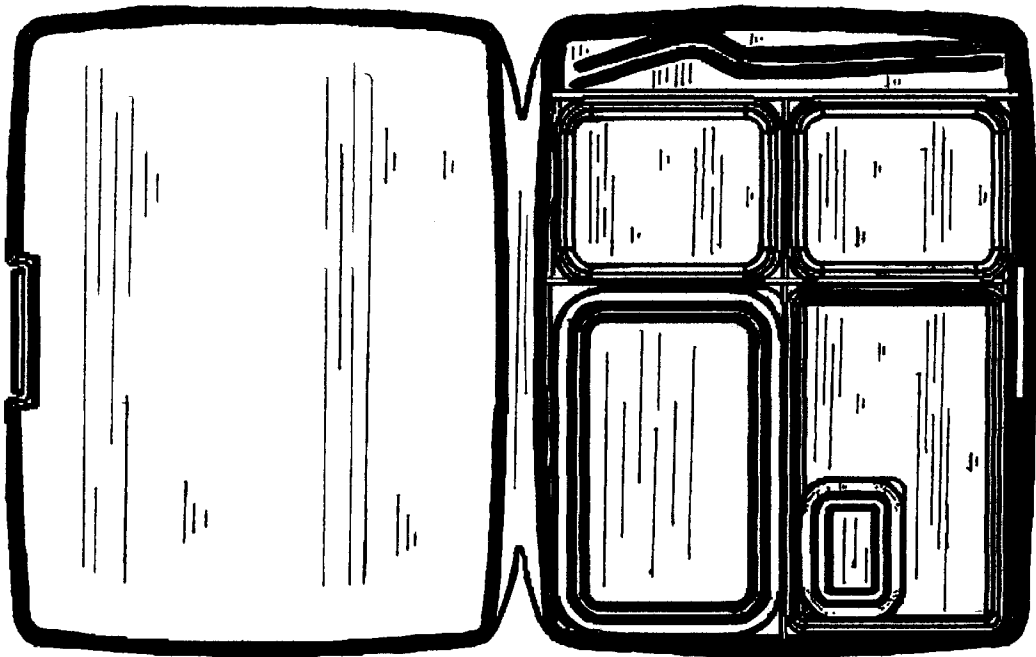

Fig. 7

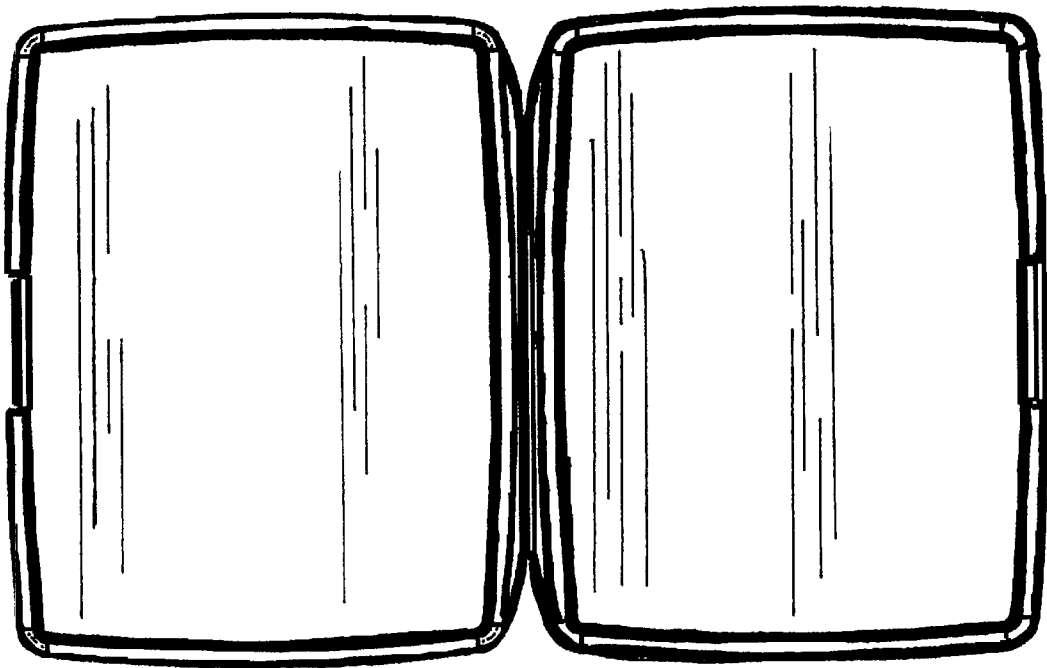

Fig. 8