

[54] CONTAINER FOR CONFECTIONERY PRODUCTS

[75] Inventor: Pietro Ferrero, Brussels, Belgium

[73] Assignee: Ferrero Ardennes S.A., Arlon, Belgium

[\*\*] Term: 14 Years

[21] Appl. No.: 479,554

[22] Filed: Feb. 13, 1990

[30] Foreign Application Priority Data

Sep. 29, 1989 [IT] Italy ..... 53387-B/89

[52] U.S. Cl. .... D9/318

[58] Field of Search ..... D9/307, 310, 318; D7/516, 595, 599, 613, 628; D3/66, 44; D21/148, 161, 186; D99/38, 40; D11/158; D1/110

[56] References Cited

U.S. PATENT DOCUMENTS

D. 151,633	11/1948	Graboi	.....	D21/161 X
D. 217,174	4/1970	Northup	.....	D21/186 X
D. 261,914	11/1981	Marconi	.....	D21/161
D. 266,938	11/1982	Barton	.....	D21/148
D. 267,283	12/1982	Nagode	.....	D99/40
D. 287,334	12/1986	Ferrero	.....	D9/318

Primary Examiner—Bernard Ansher

Assistant Examiner—C. Tuttle

Attorney, Agent, or Firm—Rothwell, Figg, Ernst & Kurz

[57] CLAIM

The ornamental design for a container for confectionery products, as shown.

DESCRIPTION

FIG. 1 is a front elevational view of a container for confectionery products showing my new design; FIG. 2 is a right side elevational view thereof; FIG. 3 is a rear elevational view thereof; FIG. 4 is a bottom plan view thereof; FIG. 5 is a left side elevational view thereof; FIG. 6 is a top plan view thereof; and FIG. 7 is a perspective view thereof.

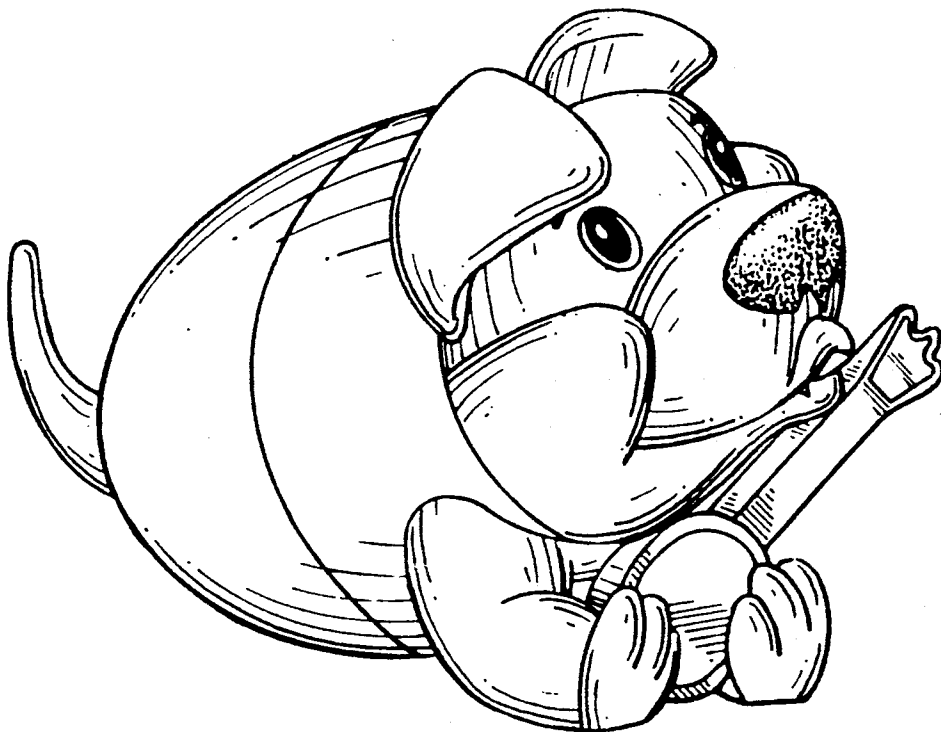

FIG. 1

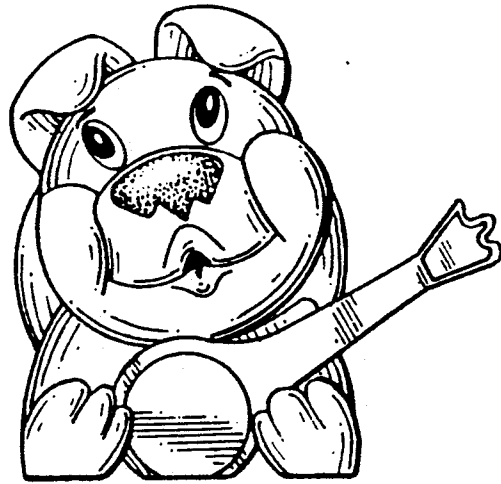

FIG. 2

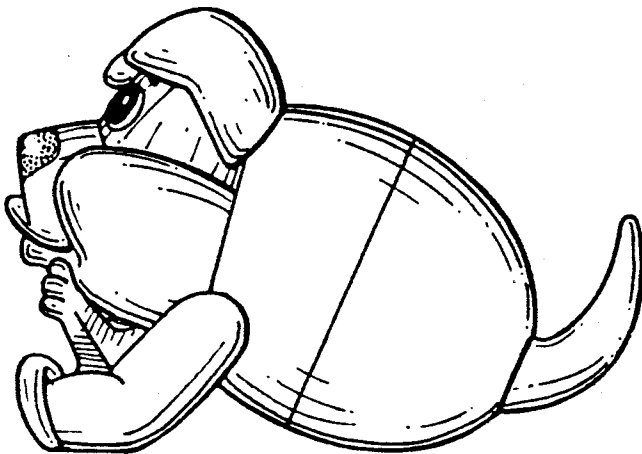

FIG. 3

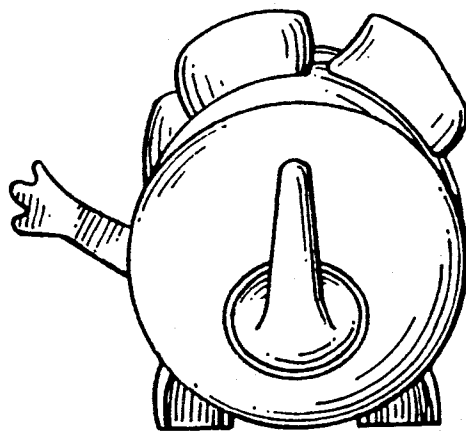

FIG. 4

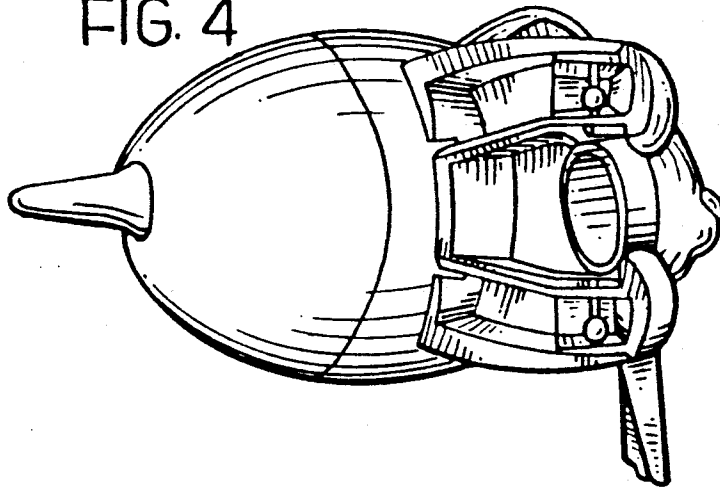

FIG. 5

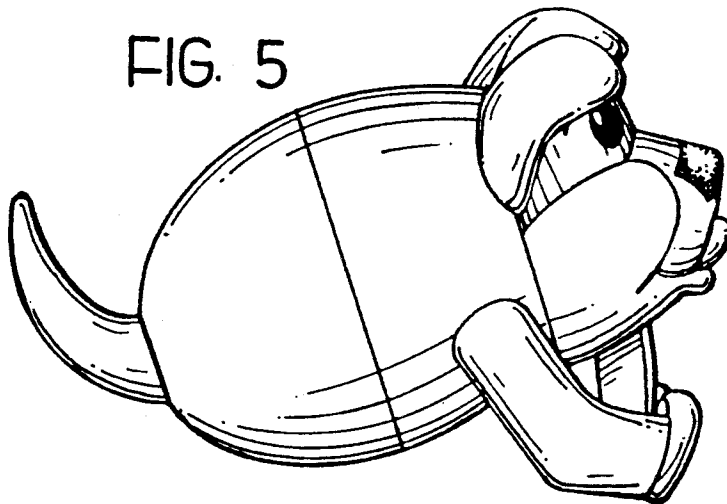

FIG. 6

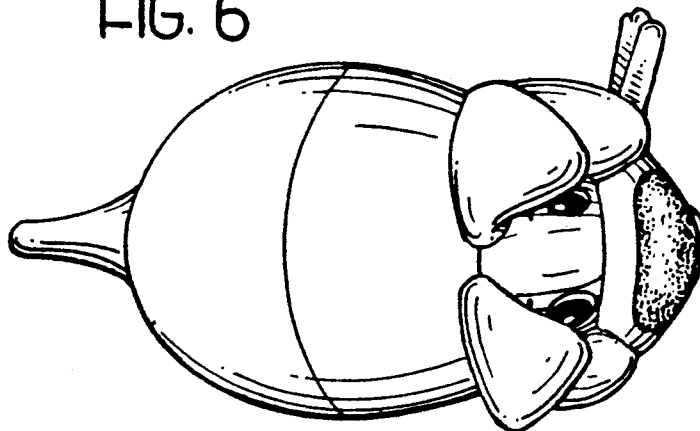

FIG. 7

