



US00D949428S

(12) **United States Design Patent**  
**Sedic**

(10) **Patent No.:** **US D949,428 S**

(45) **Date of Patent:** **\*\* Apr. 19, 2022**

- (54) **PERSONAL MASSAGER**
- (71) Applicant: **Filip Sedic**, Stockholm (SE)
- (72) Inventor: **Filip Sedic**, Stockholm (SE)
- (73) Assignee: **LELO Inc.**, San Jose, CA (US)
- (\*\*) Term: **15 Years**
- (21) Appl. No.: **29/779,820**
- (22) Filed: **Apr. 21, 2021**

|          |   |   |         |          |       |         |
|----------|---|---|---------|----------|-------|---------|
| D857,224 | S | * | 8/2019  | Fuhner   | ..... | D24/215 |
| D861,911 | S | * | 10/2019 | Fuhner   | ..... | D24/215 |
| D875,267 | S | * | 2/2020  | Zeng     | ..... | D24/214 |
| D879,990 | S | * | 3/2020  | Qiu      | ..... | D24/215 |
| D879,992 | S | * | 3/2020  | Li       | ..... | D24/215 |
| D882,109 | S | * | 4/2020  | Qiu      | ..... | D24/215 |
| D884,206 | S | * | 5/2020  | Haddock  | ..... | D24/215 |
| D884,914 | S | * | 5/2020  | Gao      | ..... | D24/215 |
| D890,945 | S | * | 7/2020  | Lee      | ..... | D24/215 |
| D890,946 | S | * | 7/2020  | Lee      | ..... | D24/215 |
| D897,552 | S | * | 9/2020  | Meissner | ..... | D24/215 |
| D898,937 | S | * | 10/2020 | Haddock  | ..... | D24/215 |
| D905,264 | S | * | 12/2020 | Tsang    | ..... | D24/215 |
| D915,616 | S | * | 4/2021  | Lee      | ..... | D24/215 |

(Continued)

**Related U.S. Application Data**

- (63) Continuation of application No. 29/706,282, filed on Sep. 19, 2019, now Pat. No. Des. 920,530.
- (51) **LOC (13) Cl.** ..... **28-03**
- (52) **U.S. Cl.**  
USPC ..... **D24/215**
- (58) **Field of Classification Search**  
USPC ..... D24/119, 133, 141, 188, 200, 211, 212,  
D24/213, 214, 215; D30/160  
CPC .... A61H 2201/1628; A61H 2201/1645; A61H  
19/44; A61H 19/50; A61H 19/40; A61H  
19/34; A61H 2015/0042  
See application file for complete search history.

(56) **References Cited**

**U.S. PATENT DOCUMENTS**

|          |   |   |         |          |       |                       |
|----------|---|---|---------|----------|-------|-----------------------|
| D681,219 | S | * | 4/2013  | Chen     | ..... | D24/215               |
| D702,363 | S | * | 4/2014  | Tai      | ..... | D24/215               |
| D712,054 | S | * | 8/2014  | Tai      | ..... | A61H 19/40<br>D24/215 |
| D795,446 | S | * | 8/2017  | Marshall | ..... | D24/215               |
| D796,054 | S | * | 8/2017  | Chen     | ..... | D24/215               |
| D796,055 | S | * | 8/2017  | Chen     | ..... | D24/215               |
| D825,073 | S | * | 8/2018  | Lenke    | ..... | D24/215               |
| D836,792 | S | * | 12/2018 | Fuhner   | ..... | D24/215               |
| D850,644 | S | * | 6/2019  | Sedic    | ..... | D24/215               |
| D854,181 | S | * | 7/2019  | Wei      | ..... | D24/215               |

**OTHER PUBLICATIONS**

Amazon, "ENIGMA Deep Rose", Oct. 29, 2021. <https://www.lelo.com/enigma>. Shown on p. 1. (Year: 2021).\*

(Continued)

*Primary Examiner* — Michael A Maharajh  
(74) *Attorney, Agent, or Firm* — Evan Feldstein

(57) **CLAIM**

I claim the ornamental design for a personal massager, as shown and described.

**DESCRIPTION**

FIG. 1 is a perspective view of a personal massager.  
FIG. 2 is a left side view of the personal massager.  
FIG. 3 is a right side view of the personal massager.  
FIG. 4 is a rear view of the personal massager.  
FIG. 5 is a front view of the personal massager.  
FIG. 6 is a bottom view of the personal massager; and,  
FIG. 7 is a top view of the personal massager.  
The broken lines in the drawings are for the purpose of illustrating portions of the personal massager, which form no part of the claimed design.

**1 Claim, 7 Drawing Sheets**

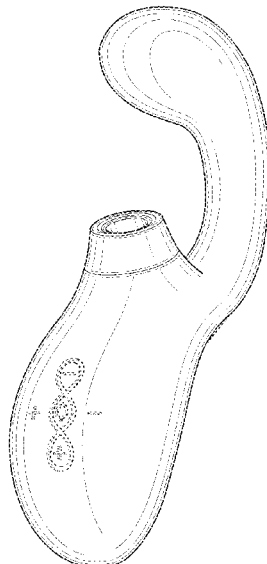

(56)

**References Cited**

U.S. PATENT DOCUMENTS

D917,062 S \* 4/2021 Lee ..... D24/215  
D920,530 S \* 5/2021 Sedic ..... D24/215  
11,007,113 B2 \* 5/2021 Haddock ..... A61H 23/02  
2017/0027809 A1 \* 2/2017 Lenke ..... A61H 19/40  
2017/0367926 A1 \* 12/2017 Verreault ..... G08C 23/04

OTHER PUBLICATIONS

Amazon, "LELO Enigma", Sep. 7, 2021. [https://www.amazon.com/LELO-Stimulation-Massager-Waterproof-Vibrating/dp/B08XNHDT6D/ref=cm\\_cr\\_ar\\_p\\_d\\_pl\\_foot\\_top?ie=UTF8&th=1](https://www.amazon.com/LELO-Stimulation-Massager-Waterproof-Vibrating/dp/B08XNHDT6D/ref=cm_cr_ar_p_d_pl_foot_top?ie=UTF8&th=1). Shown on p. 1. (Year: 2021).\*

\* cited by examiner

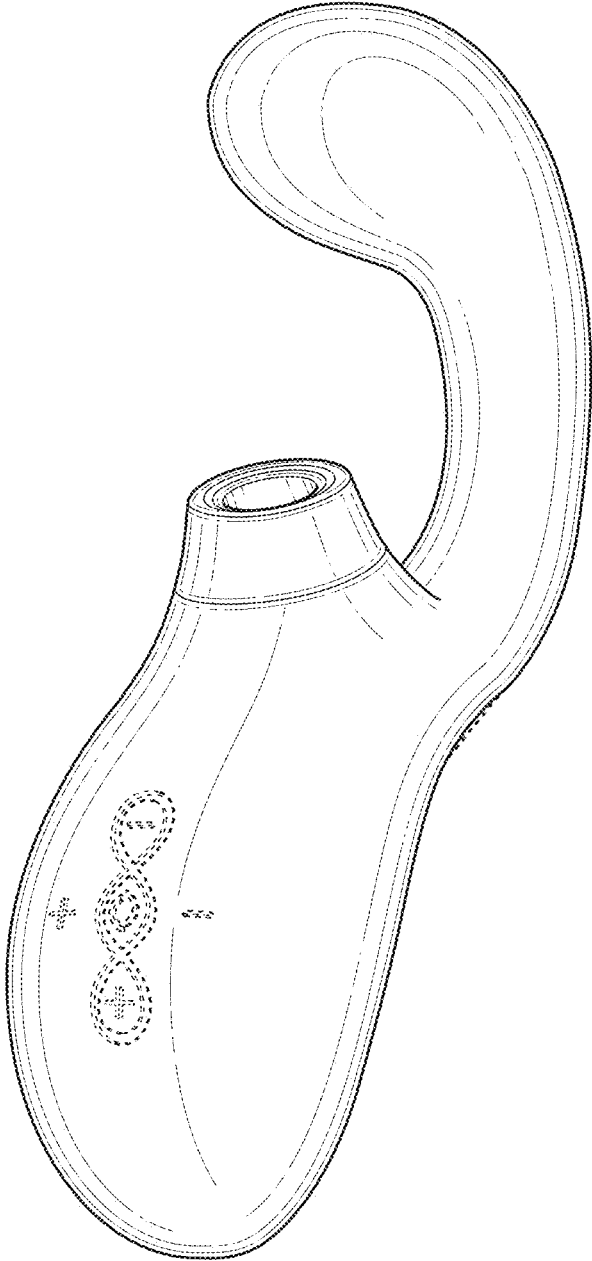

FIG. 1

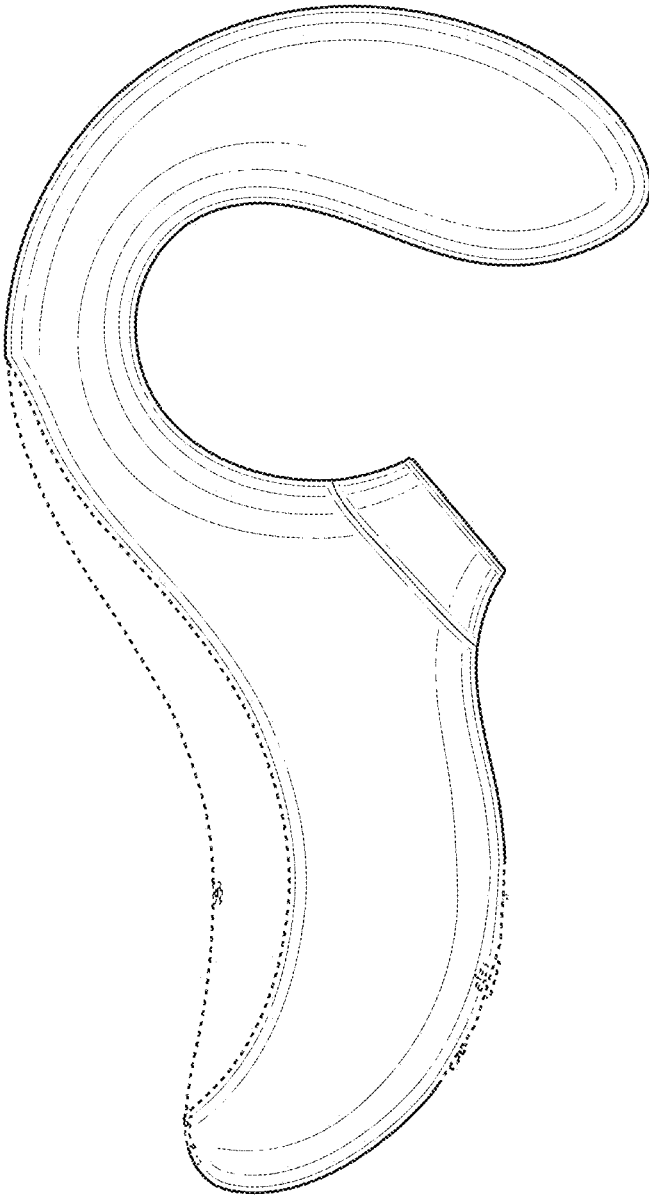

FIG. 2

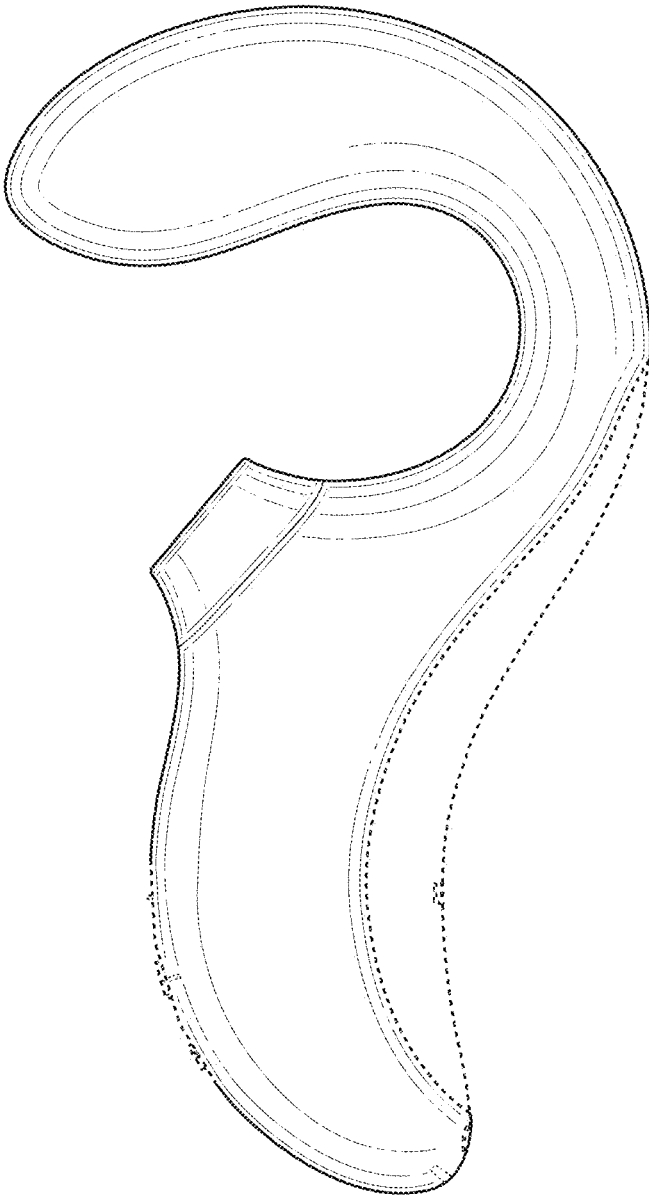

FIG. 3

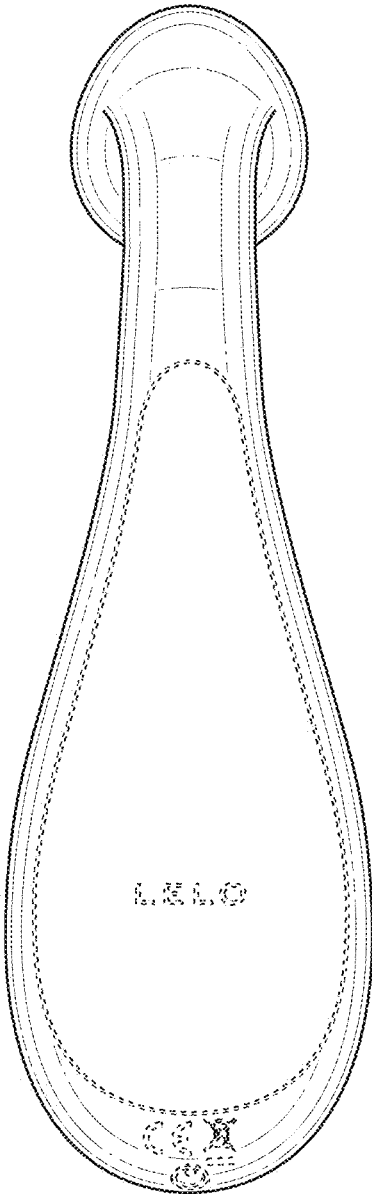

FIG. 4

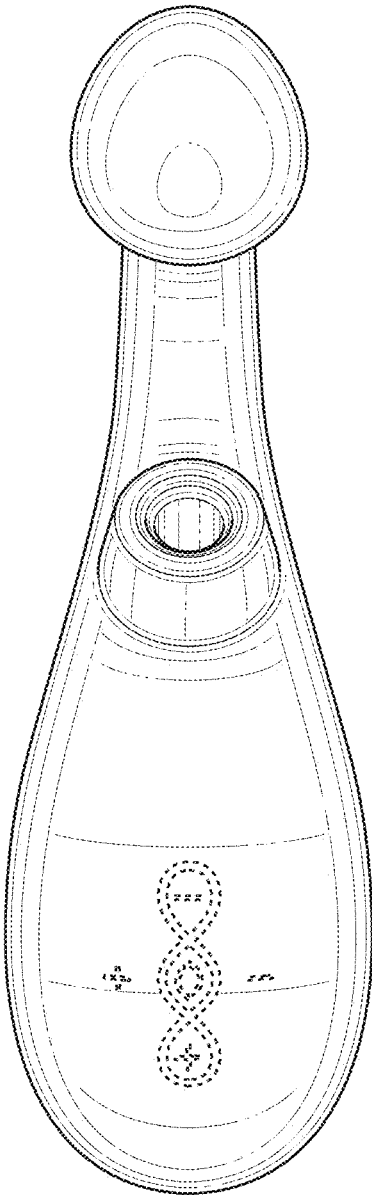

FIG. 5

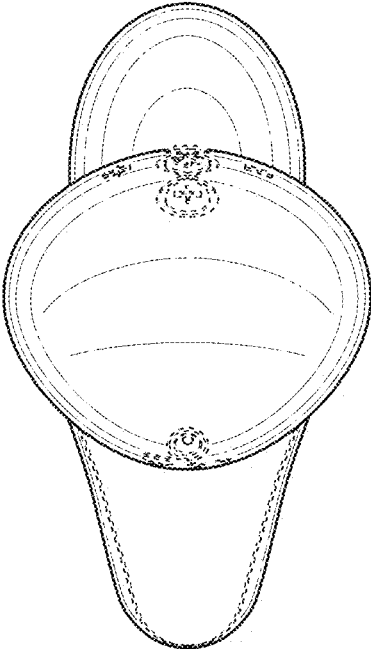

FIG. 6



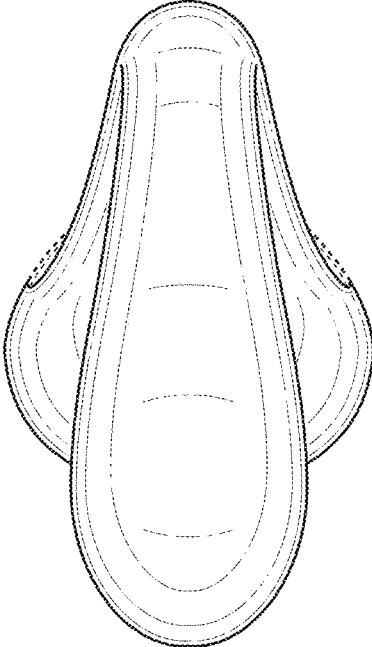

FIG. 7