



US00D824235S

(12) **United States Design Patent**
Schneider

(10) **Patent No.:** **US D824,235 S**

(45) **Date of Patent:** **** Jul. 31, 2018**

(54) **HANDLE**

(71) Applicant: **Spectrum Brands, Inc.**, Middleton, WI (US)

(72) Inventor: **Elliott Schneider**, Foothill Ranch, CA (US)

(73) Assignee: **Spectrum Brands, Inc.**, Middleton, WI (US)

(**) Term: **15 Years**

(21) Appl. No.: **29/599,291**

(22) Filed: **Mar. 31, 2017**

(51) **LOC (11) Cl.** **08-06**

(52) **U.S. Cl.**
USPC **D8/308**

(58) **Field of Classification Search**
USPC D8/300-302, 307-309, 310, 311, 10;
D23/250, 252; 292/336.3

CPC Y10T 16/44; Y10T 74/20612; Y10T 74/20732; Y10T 16/458; Y10T 16/498; Y10T 16/469; Y10T 16/476; Y10T 74/20744; Y10T 74/20864; Y10T 16/4628; Y10T 74/20642; Y10T 16/473; Y10T 74/20762; Y10T 74/2042; Y10T 74/20828; Y10T 16/459; Y10T 16/4713; Y10T 74/2014; Y10T 16/50; Y10T 74/20438; Y10T 74/20582; Y10T 74/20738; Y10T 16/48; Y10T 74/20618; Y10T 74/20684; Y10T 74/20624; Y10T 74/20468; Y10T 16/61; Y10T 16/4719; Y10T 16/86; Y10S 16/30; Y10S 292/31; Y10S 292/53; Y10S 16/12; Y10S 292/23; Y10S 292/27; Y10S 292/30; Y10S 292/63; E05B 85/16; E05B 1/0015; E05B 77/06; E05B 79/06; E05B 85/18; E05B 85/12; E05B 85/10; E05B 7/00; E05B 1/0053; E05B 77/265

See application file for complete search history.

(56) **References Cited**

U.S. PATENT DOCUMENTS

D85,498 S *	11/1931	Teller et al.	D8/306
D332,386 S *	1/1993	Plummer	D8/308
D391,826 S *	3/1998	Diebel	D8/308
D418,737 S *	1/2000	Libby	D8/337
D509,421 S *	9/2005	Gehry	D8/300
D545,169 S *	6/2007	Kosasih	D8/308
D577,566 S *	9/2008	Grohmann	D8/308
D579,305 S *	10/2008	Schneider	D8/308
D583,212 S *	12/2008	Grohmann	D8/308

(Continued)

OTHER PUBLICATIONS

“Prime-Line 1¾ In. Swinging Screen Door Knob Latch”; The Home Depot; disclosure date unknown but prior to the filing date; <URL: <http://www.homedepot.com/p/Prime-Line-1-3-4-in-Swinging-Screen-Door-Knob-Latch-K-5000/100200883>>.

(Continued)

Primary Examiner — Lauren R Calve

(74) Attorney, Agent, or Firm — Banner & Witcoff, Ltd.

(57) **CLAIM**

The ornamental design for a handle, as shown and described.

DESCRIPTION

FIG. 1 is a front perspective view of a handle showing my new design;
FIG. 2 is a front view thereof;
FIG. 3 is a rear view thereof;
FIG. 4 is a left side view thereof;
FIG. 5 is a right side view thereof;
FIG. 6 is a top view thereof; and,
FIG. 7 is a bottom view thereof.
The broken lines shown represent unclaimed subject matter and form no part of the claimed design.

1 Claim, 4 Drawing Sheets

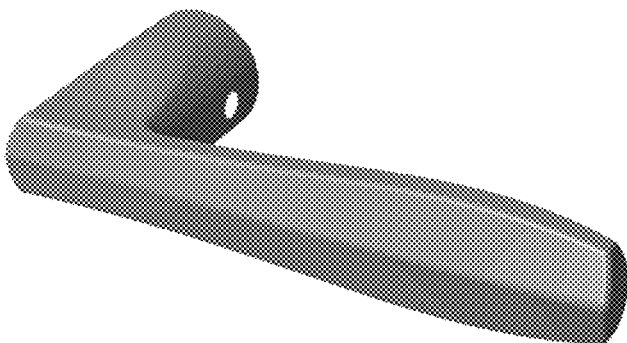

(56)

References Cited

U.S. PATENT DOCUMENTS

7,665,775 B1 * 2/2010 Miller E05B 65/0841
292/240
D621,681 S * 8/2010 Roberts, III D8/308
2017/0107739 A1 * 4/2017 Ruff E05B 45/06

OTHER PUBLICATIONS

“Montreal Square Bed/Bath Lever”; Kwikset; disclosure date unknown but prior to filing date of present application; <URL:<https://www.kwikset.com/products/details/door-levers/155mrl-sqt-15.aspx>>.

* cited by examiner

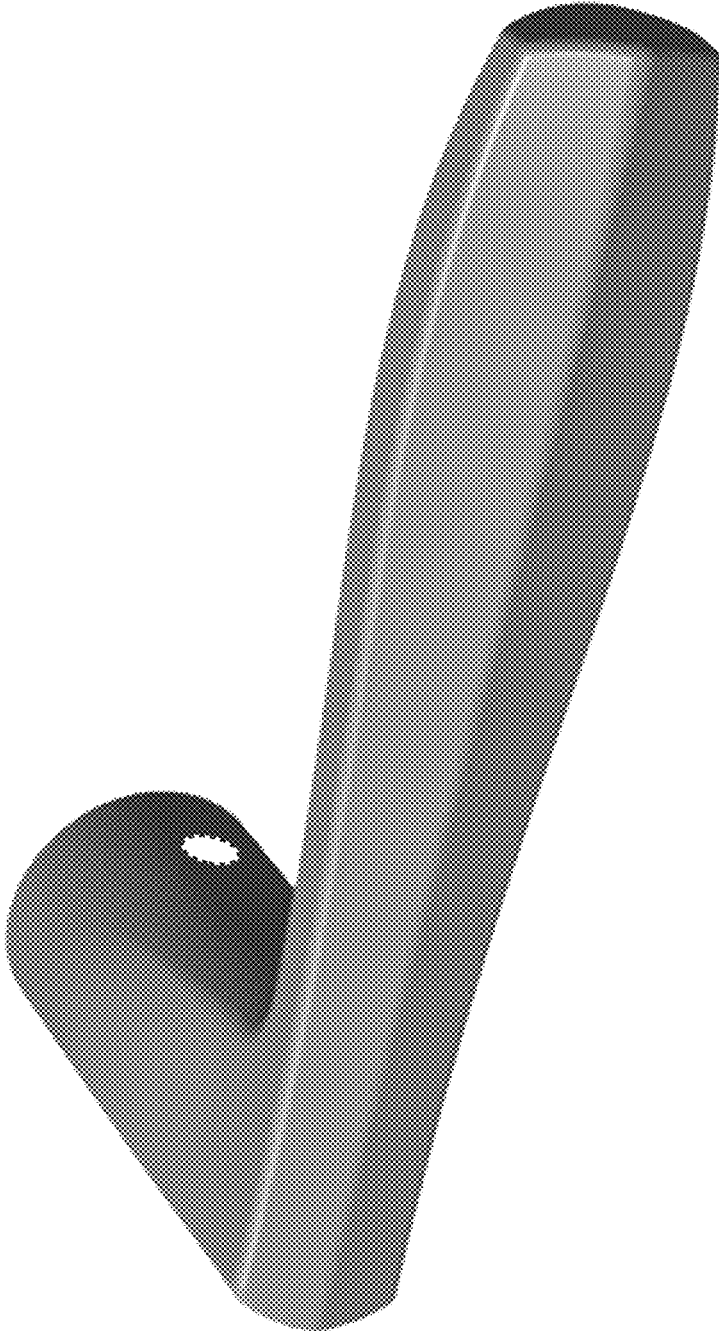

FIG. 1

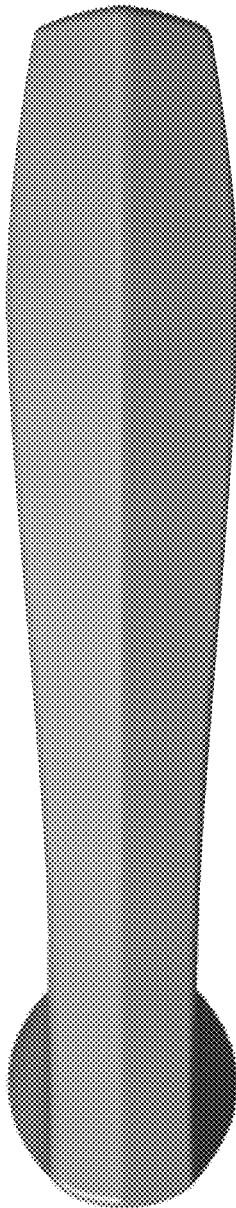

FIG. 2

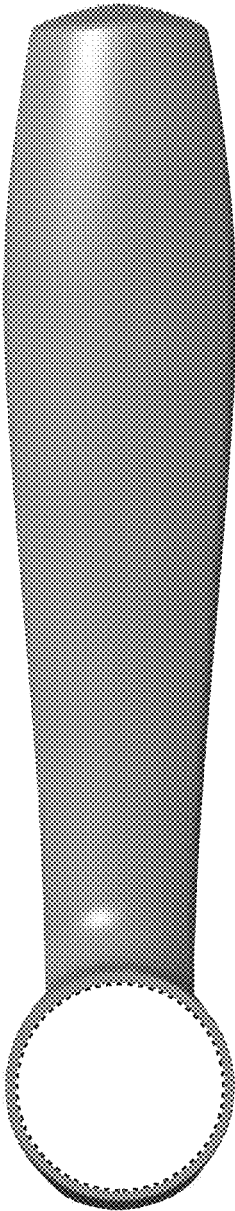

FIG. 3

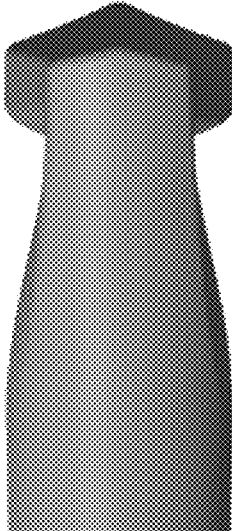

FIG. 4

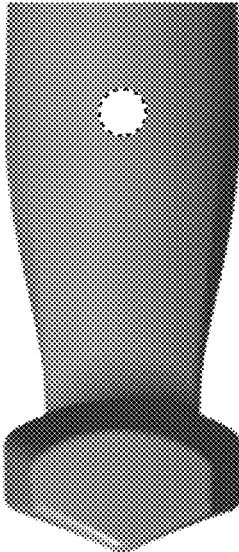

FIG. 5

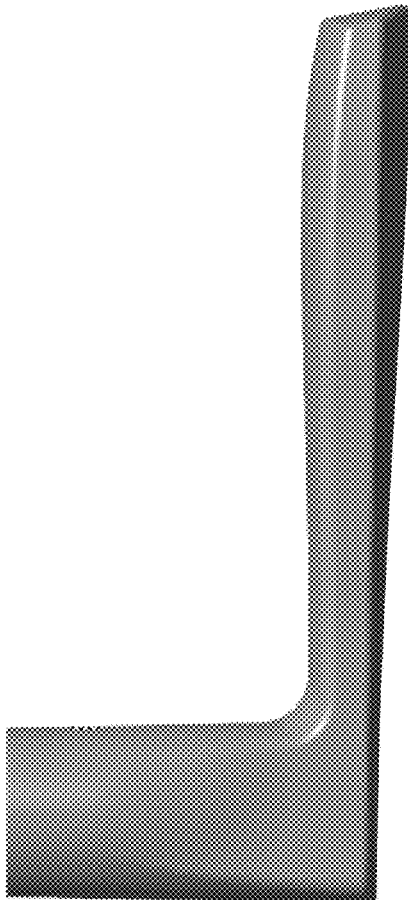

FIG. 6

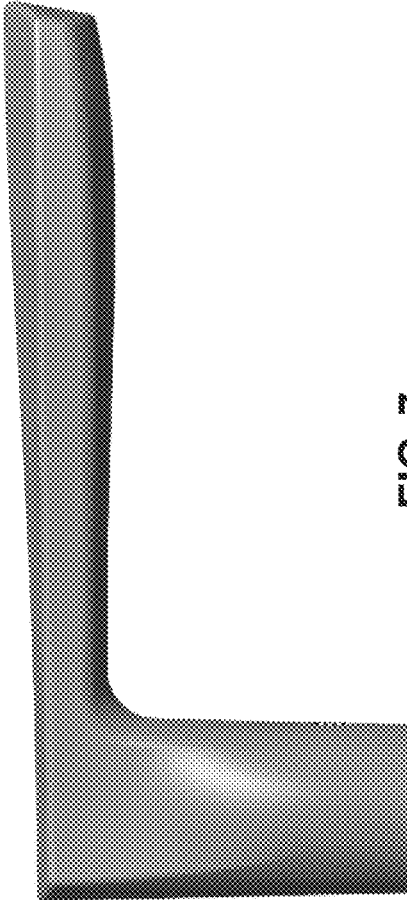

FIG. 7