



US00D647556S

(12) **United States Design Patent**  
**Chen**

(10) **Patent No.:** **US D647,556 S**

(45) **Date of Patent:** **\*\* Oct. 25, 2011**

(54) **ENGLISH ALPHABET TYPE FONT**

D51,259 S \* 9/1917 Divine ..... D18/24  
D292,417 S \* 10/1987 O'Neal ..... D18/30  
D633,001 S \* 2/2011 Chen ..... D11/184

(76) Inventor: **Tsung-Wei Chen**, Changhua (TW)

\* cited by examiner

(\*\*) Term: **14 Years**

*Primary Examiner* — Mary Ann Calabrese

(21) Appl. No.: **29/376,849**

(22) Filed: **Oct. 13, 2010**

(57) **CLAIM**

(51) **LOC (9) Cl.** ..... **18-03**

The ornamental design for an English alphabet type font, as shown and described.

(52) **U.S. Cl.** ..... **D18/32**

(58) **Field of Classification Search** ..... D18/24-33;  
101/396-399; D5/63, 64; D11/184

**DESCRIPTION**

See application file for complete search history.

FIG. 1 is a face view of an English alphabet type font showing my new design; and, FIG. 2-27 are respective individual face views of the characters of the alphabet type font of FIG. 1 shown enlarged.

(56) **References Cited**

**U.S. PATENT DOCUMENTS**

D16,425 S \* 12/1885 Beeler ..... D18/24  
D42,923 S \* 8/1912 Mason ..... D18/24

**1 Claim, 27 Drawing Sheets**

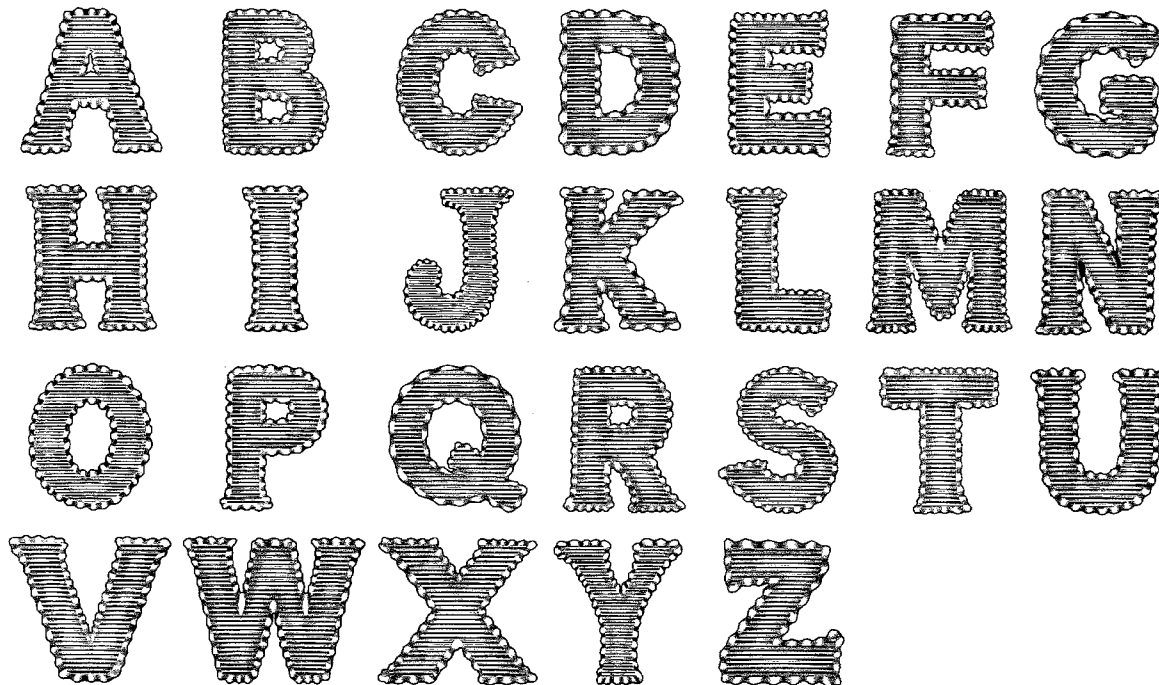

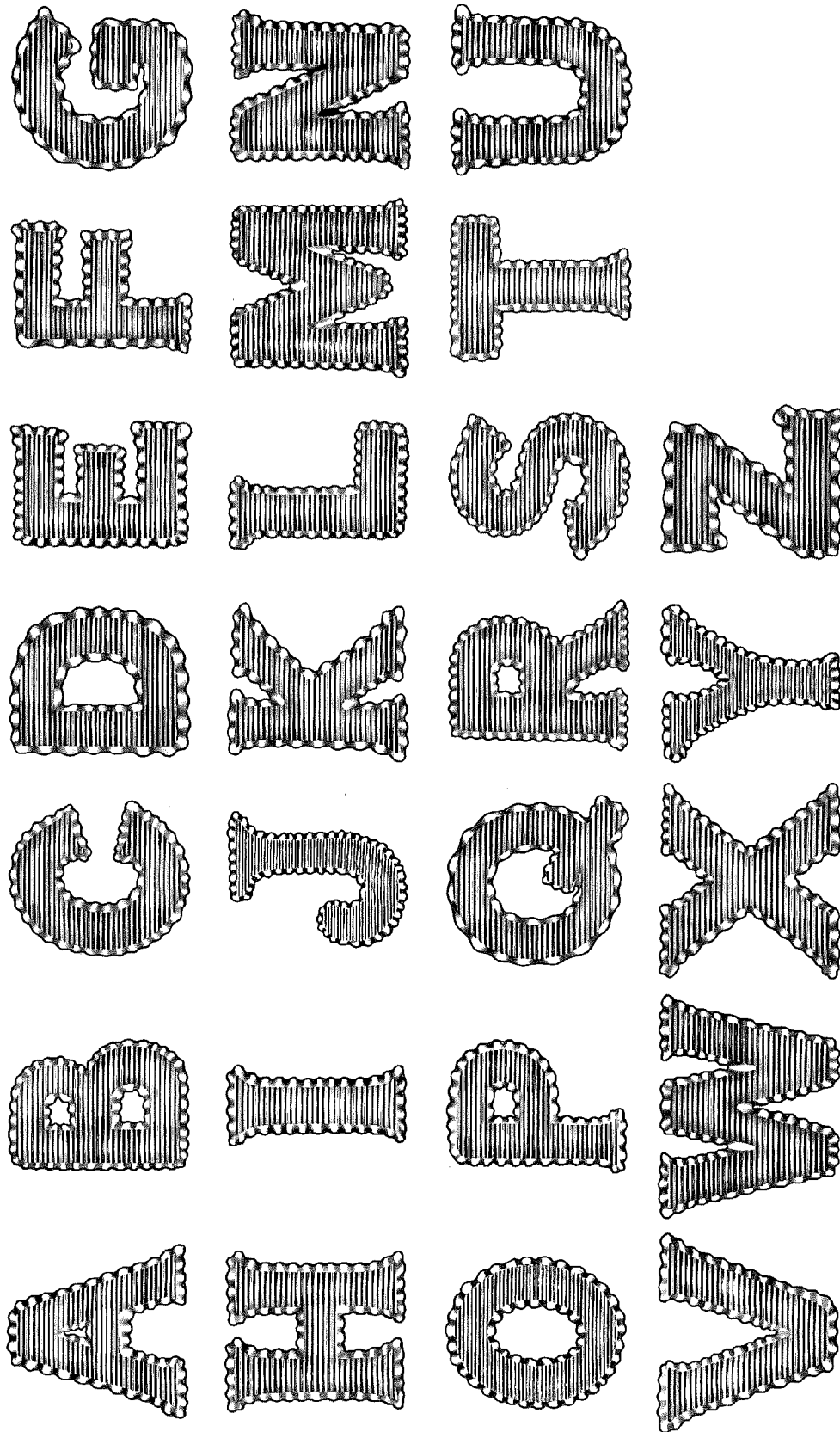

FIG. 1

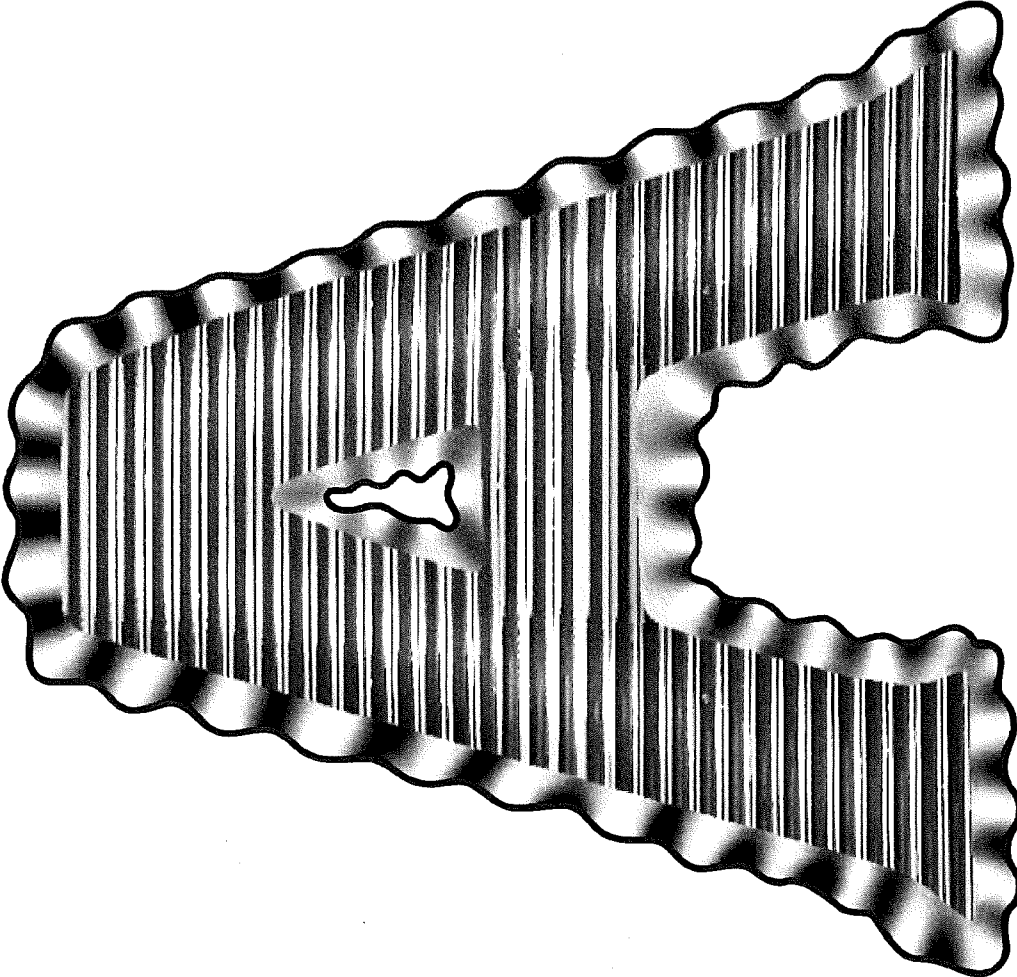

FIG. 2

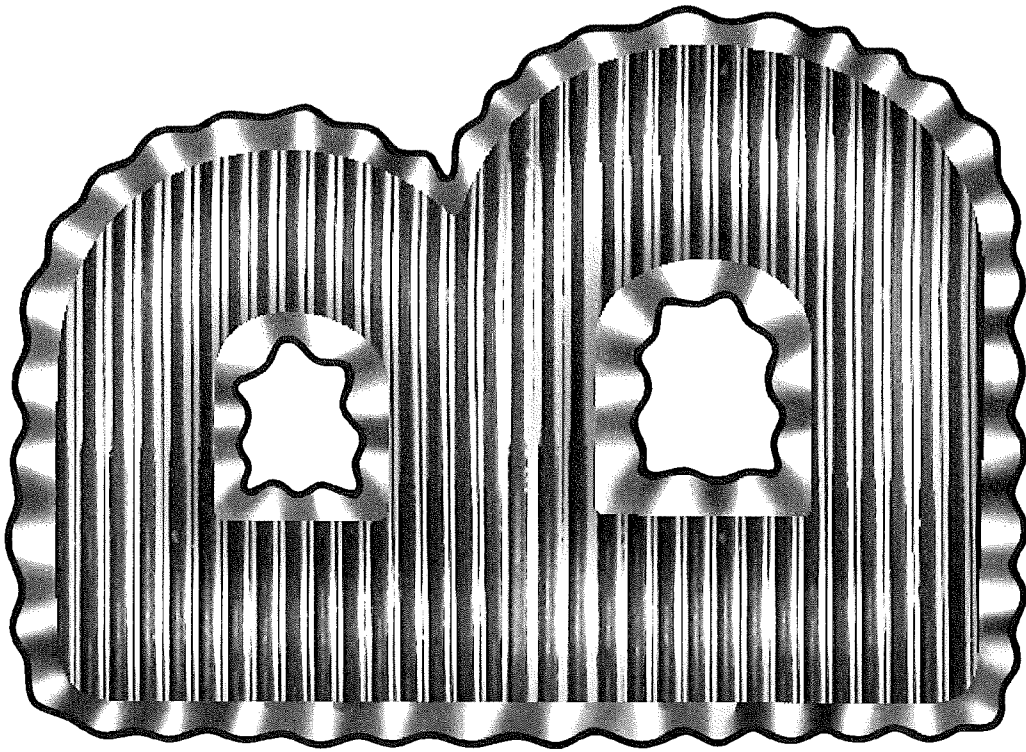

FIG. 3

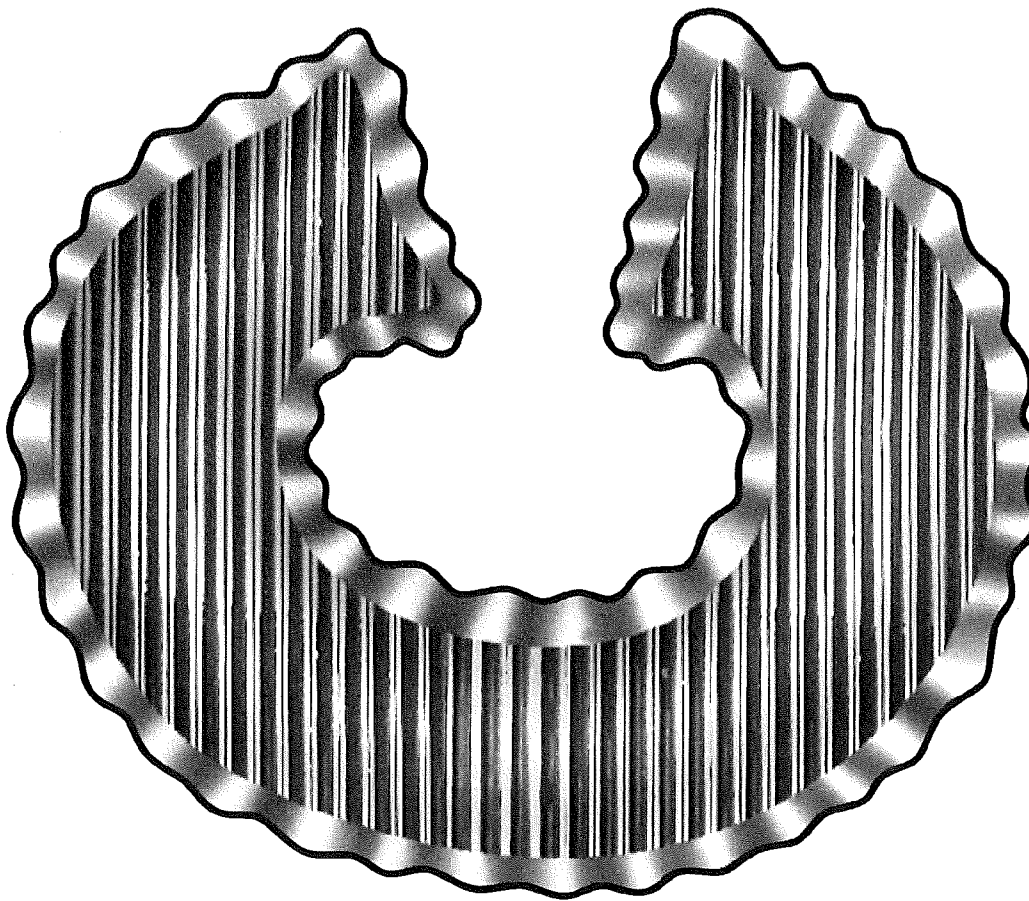

FIG. 4

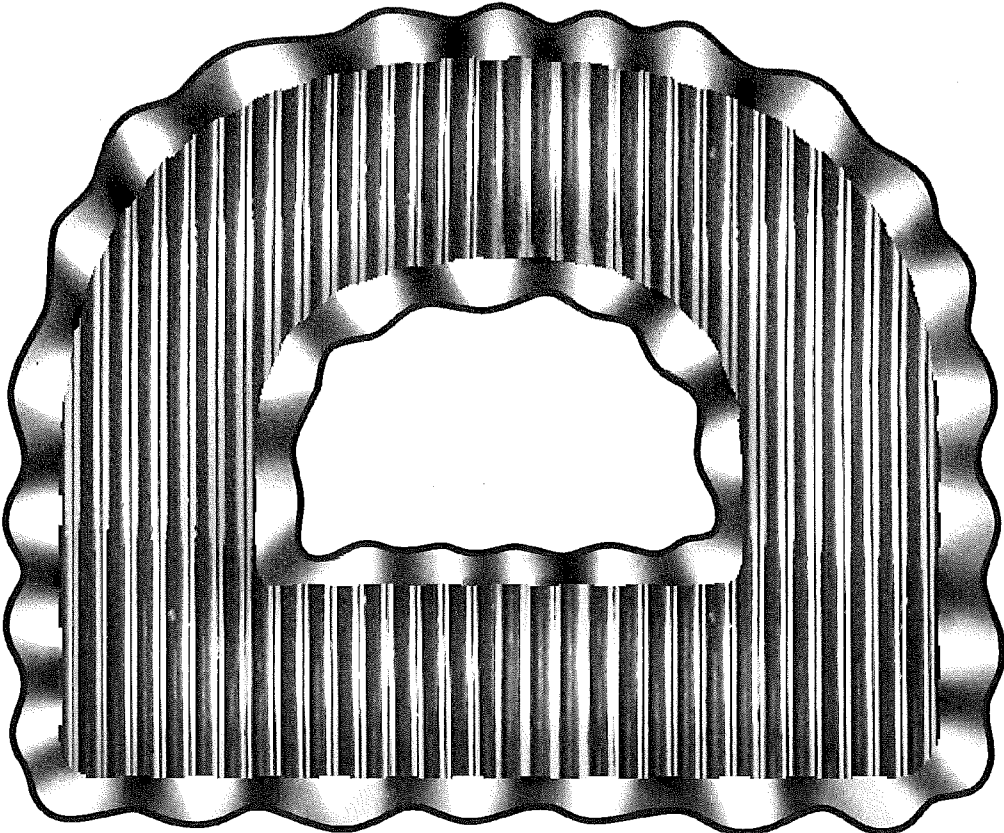

FIG. 5

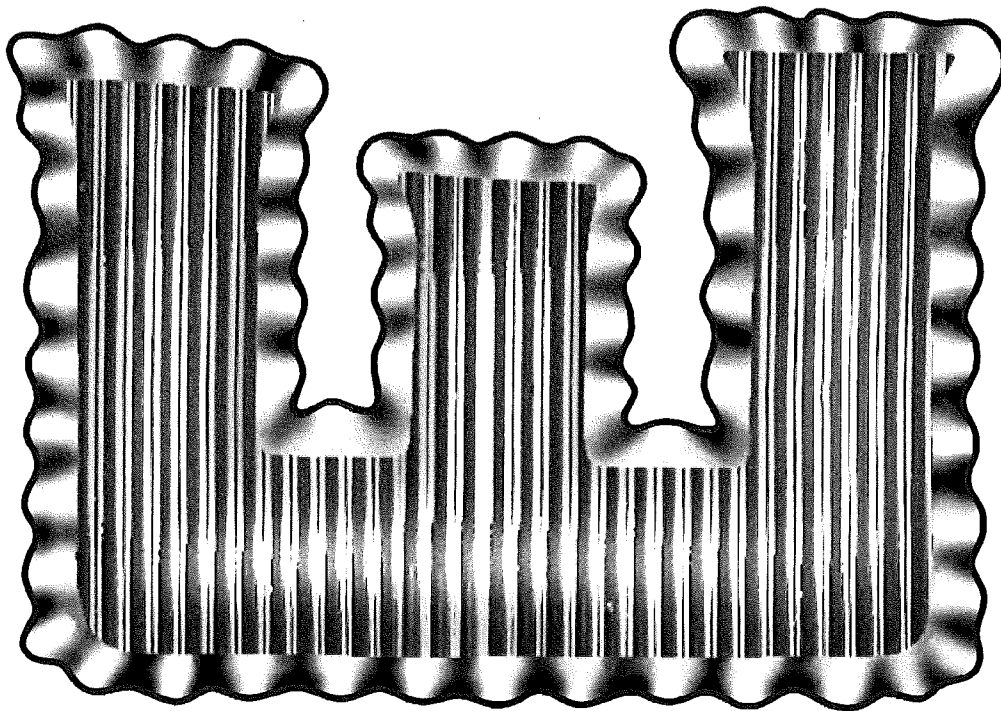

FIG. 6

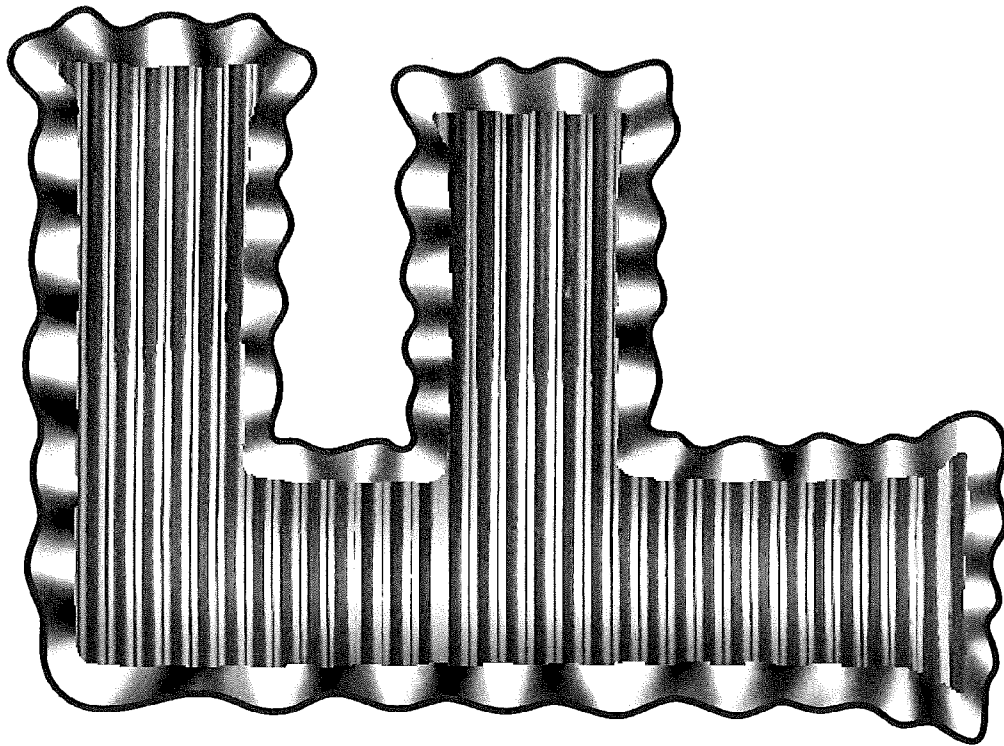

FIG. 7



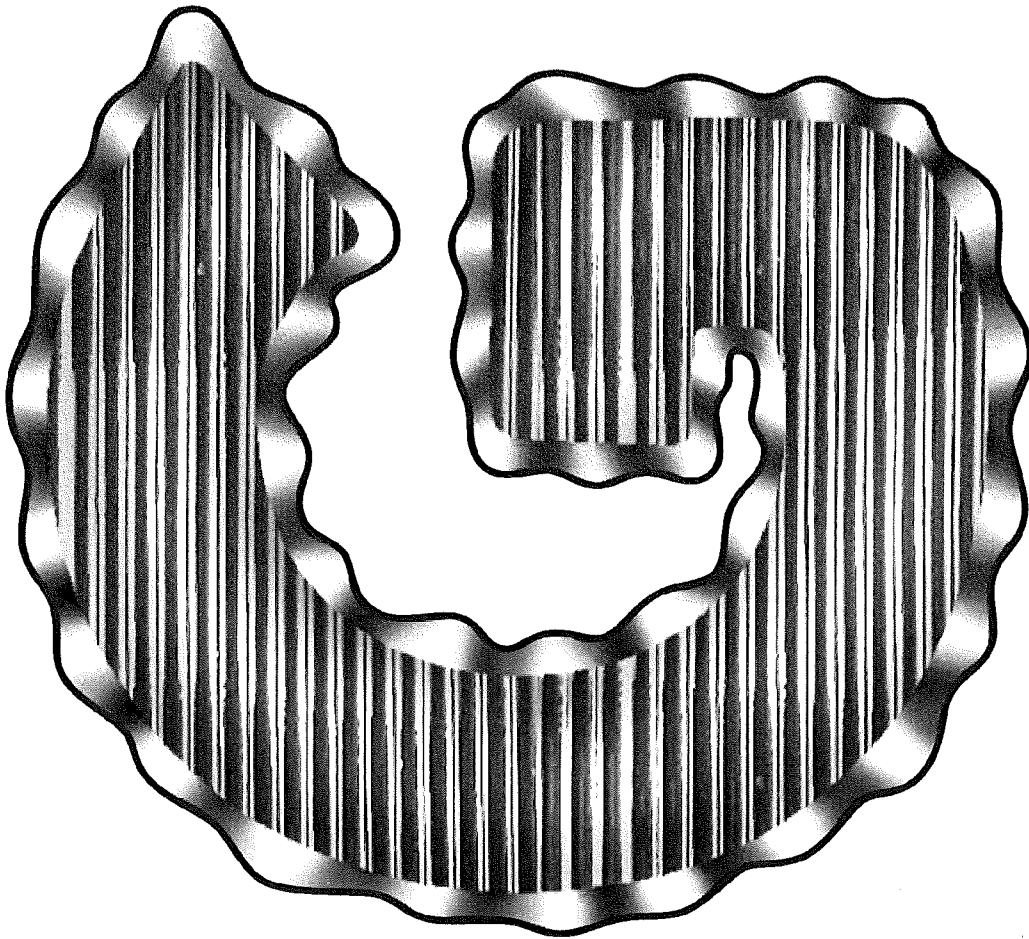

FIG. 8

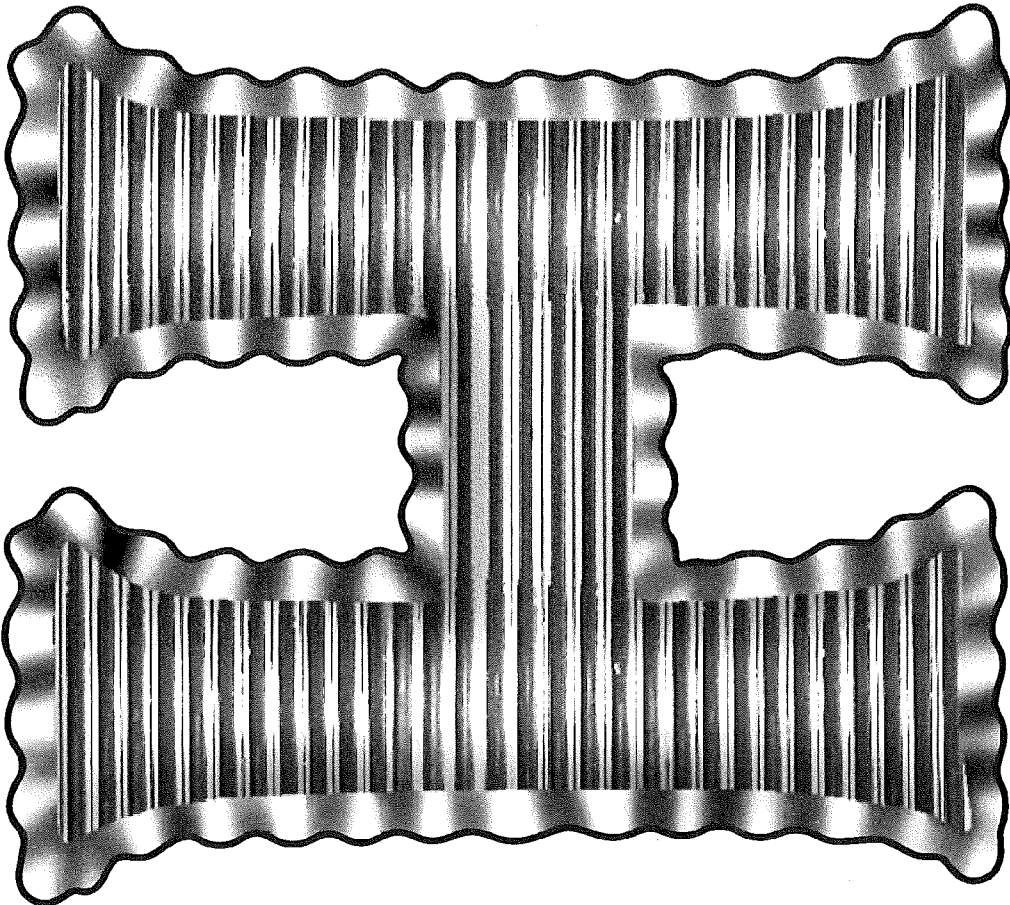

FIG. 9

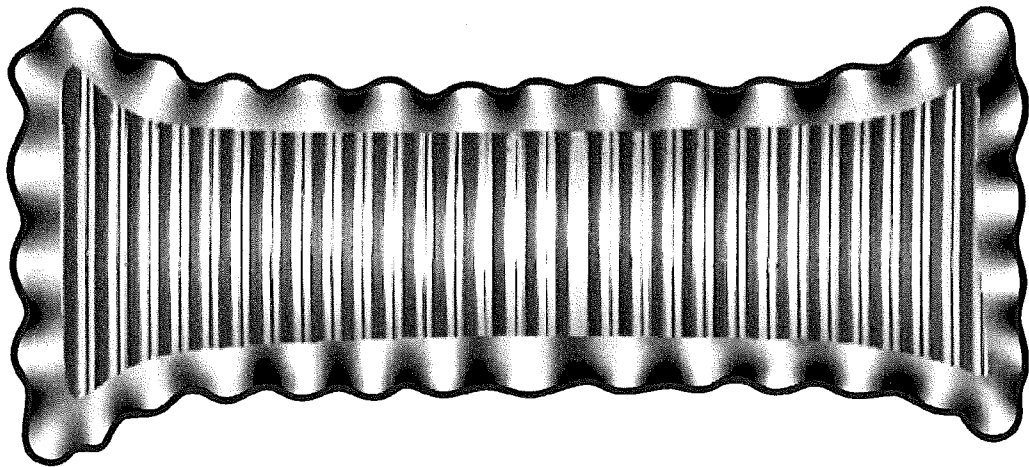

FIG. 10

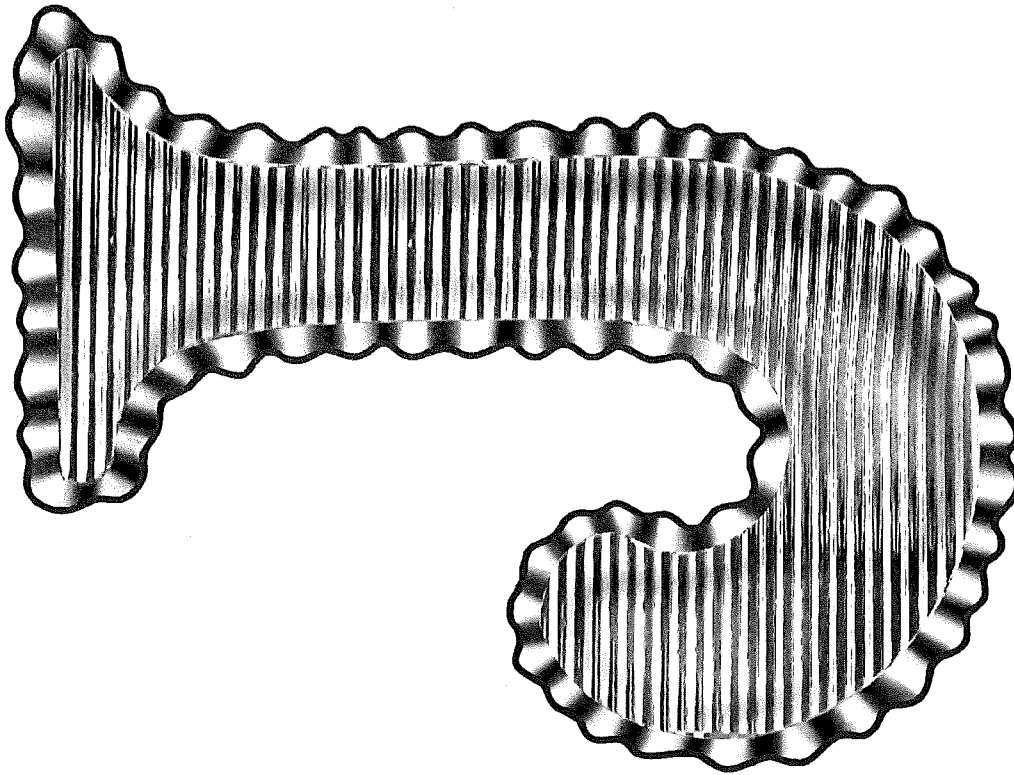

FIG. 11

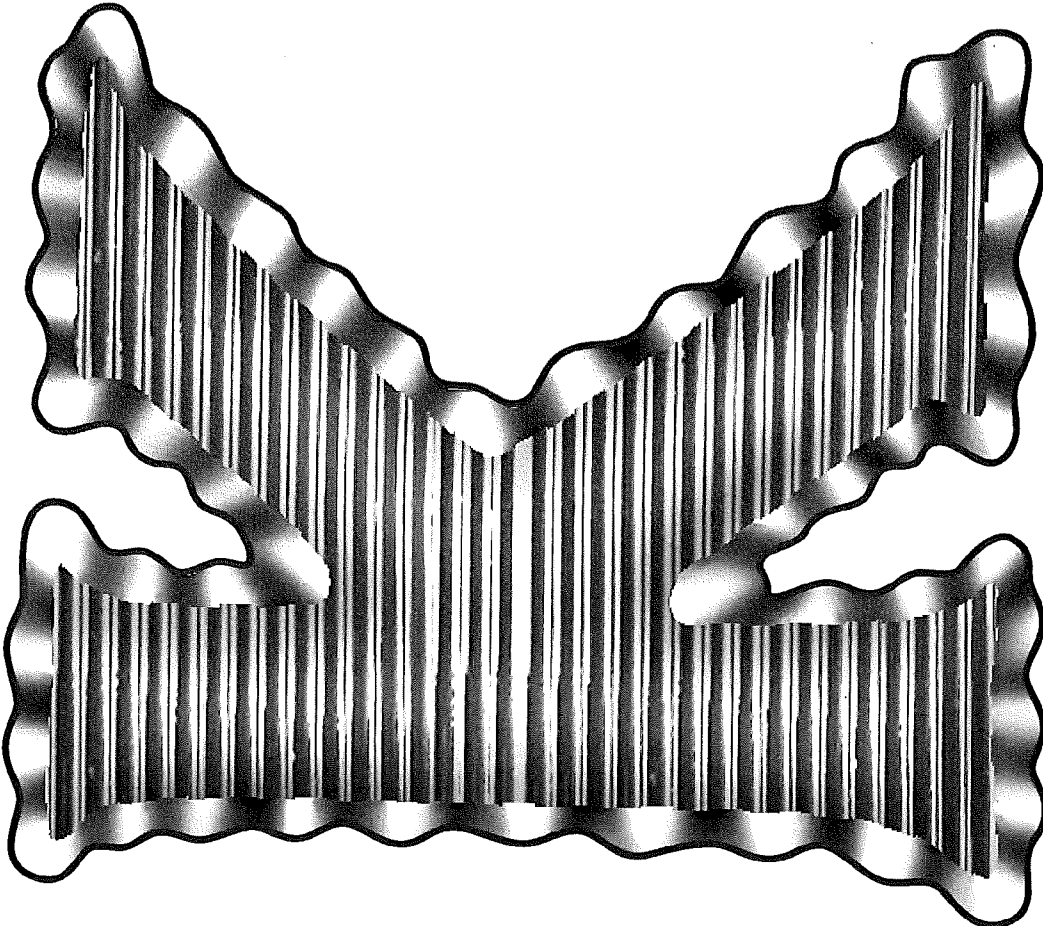

FIG. 12

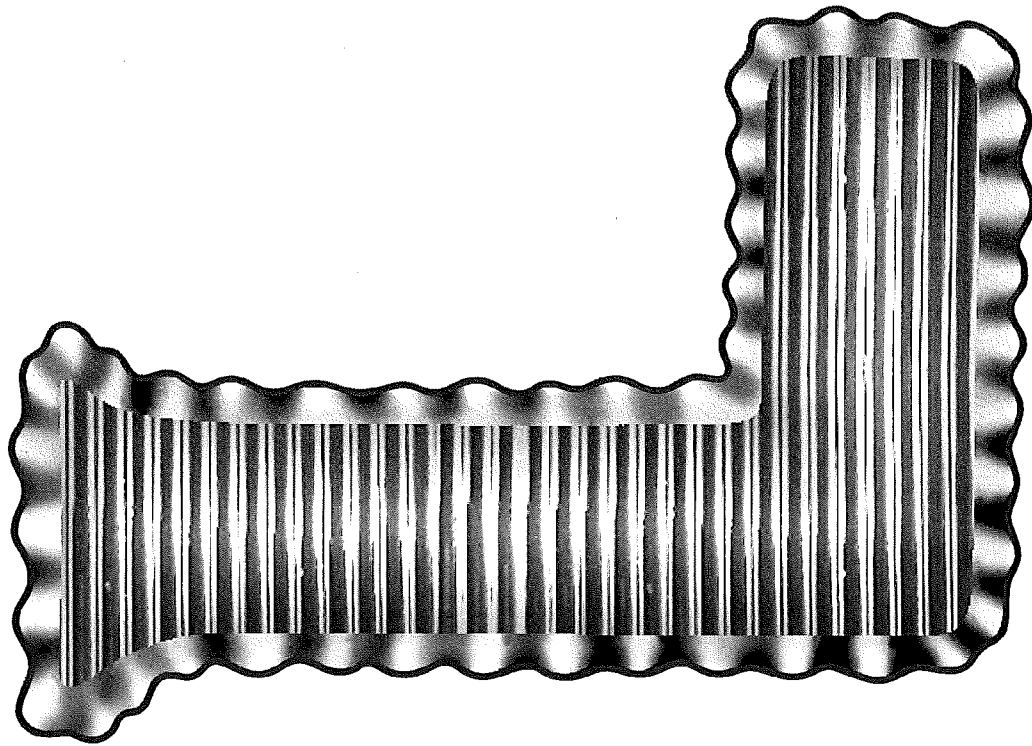

FIG. 13

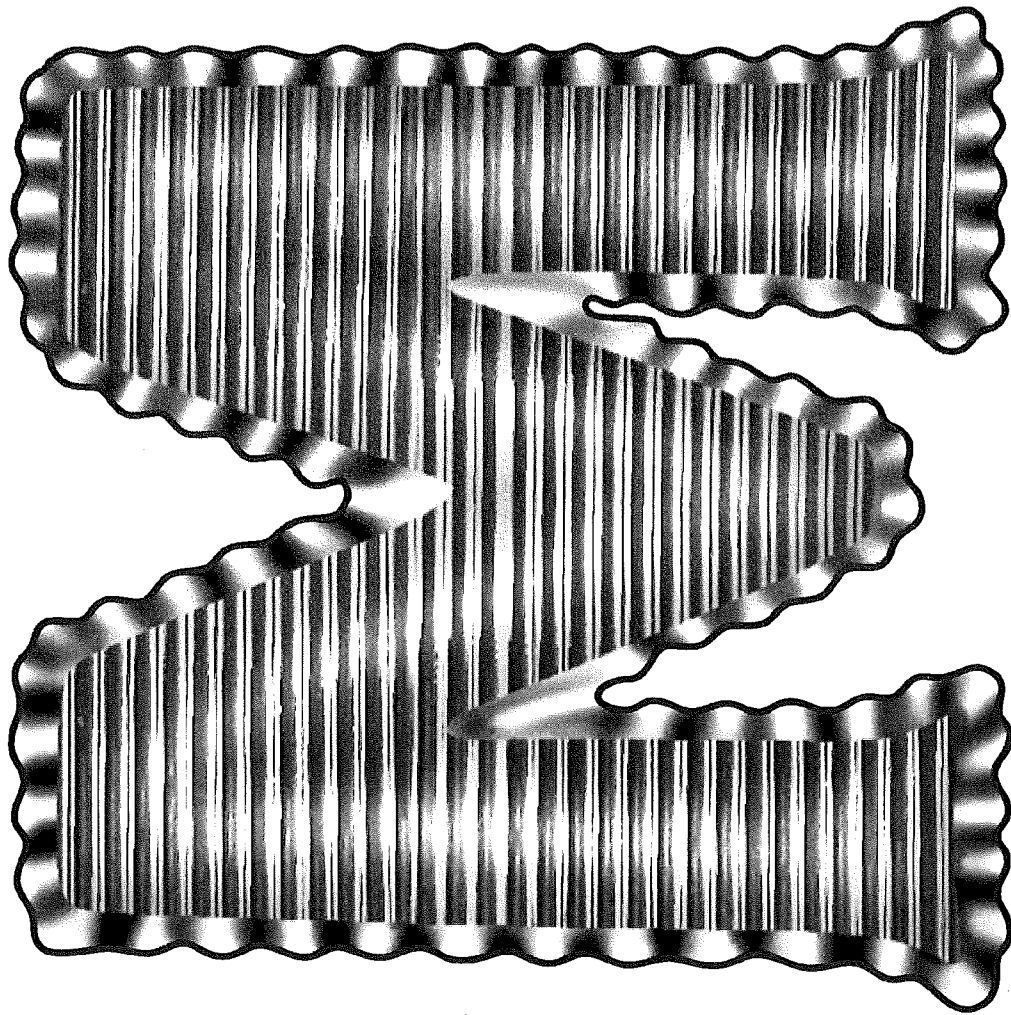

FIG. 14

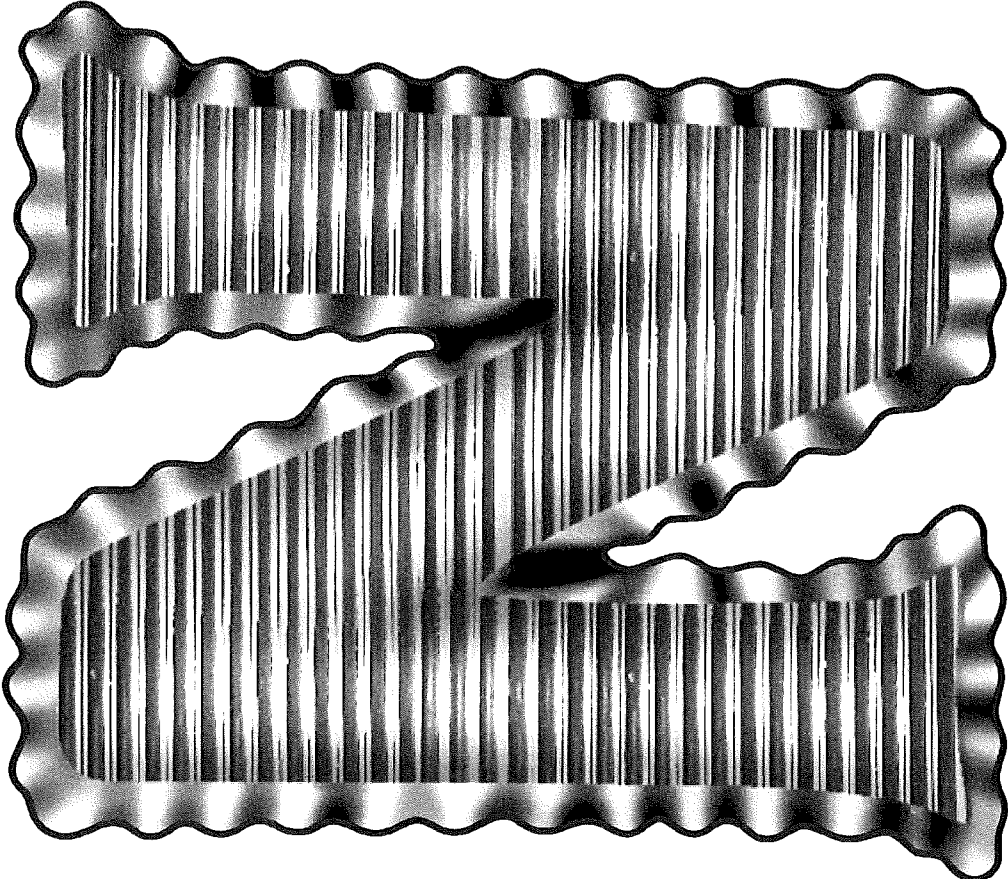

FIG. 15



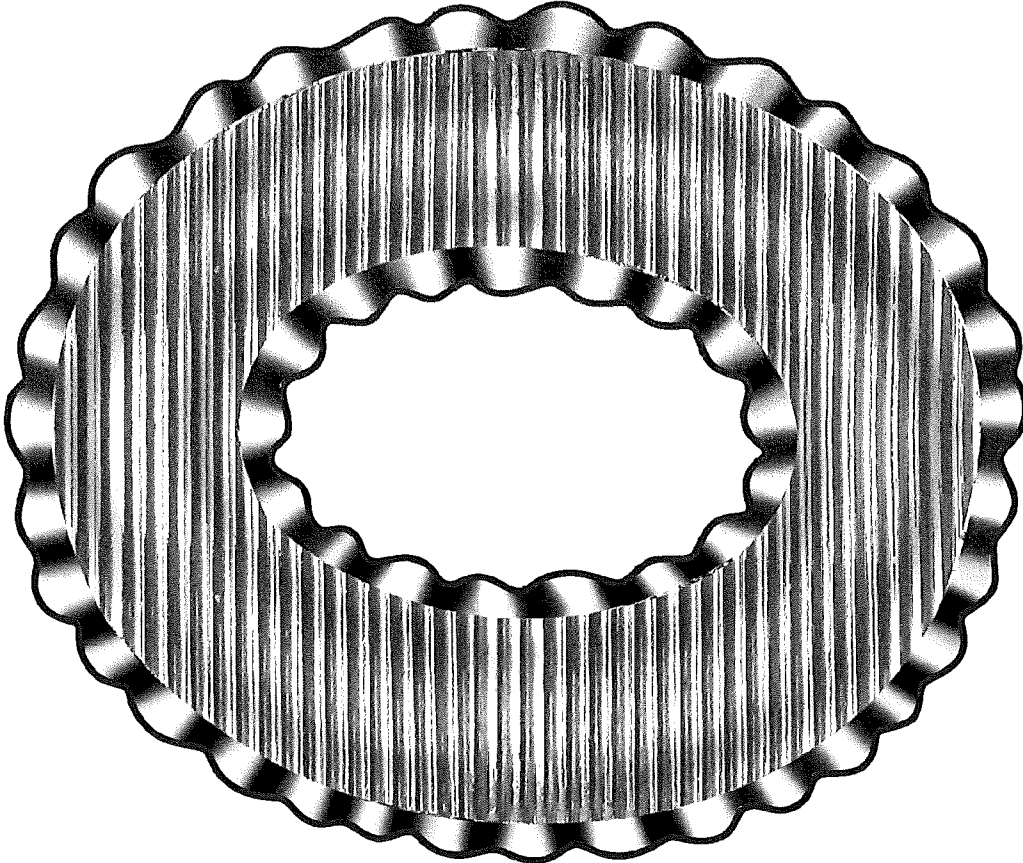

FIG. 16

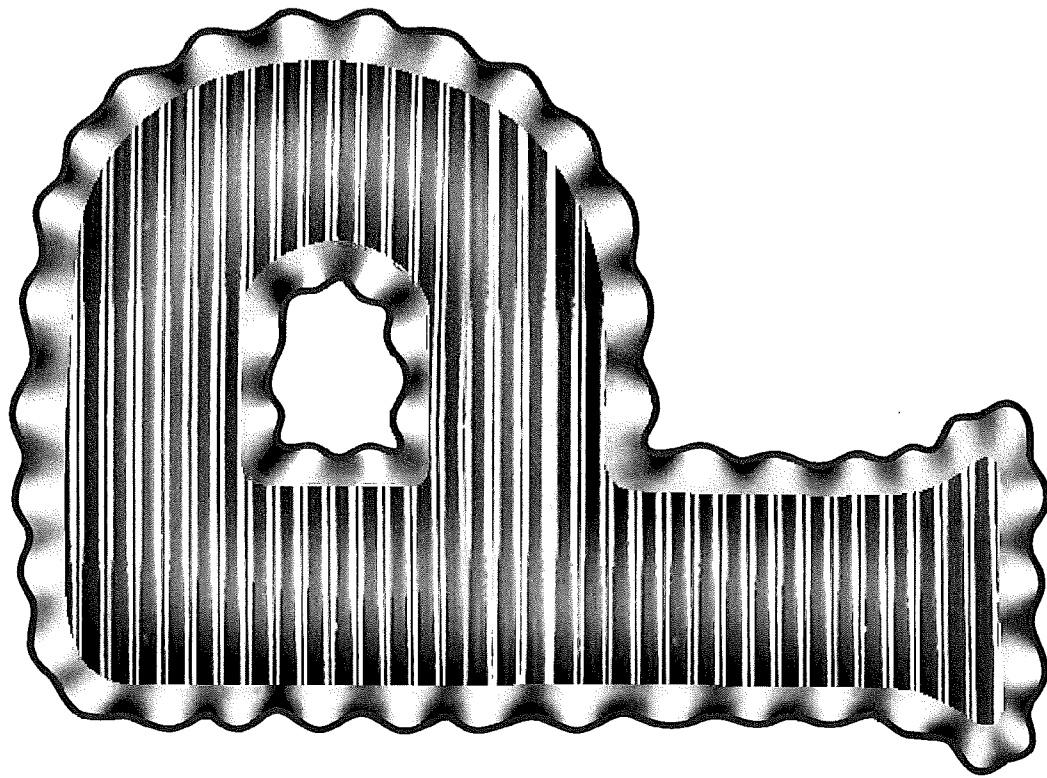

FIG. 17

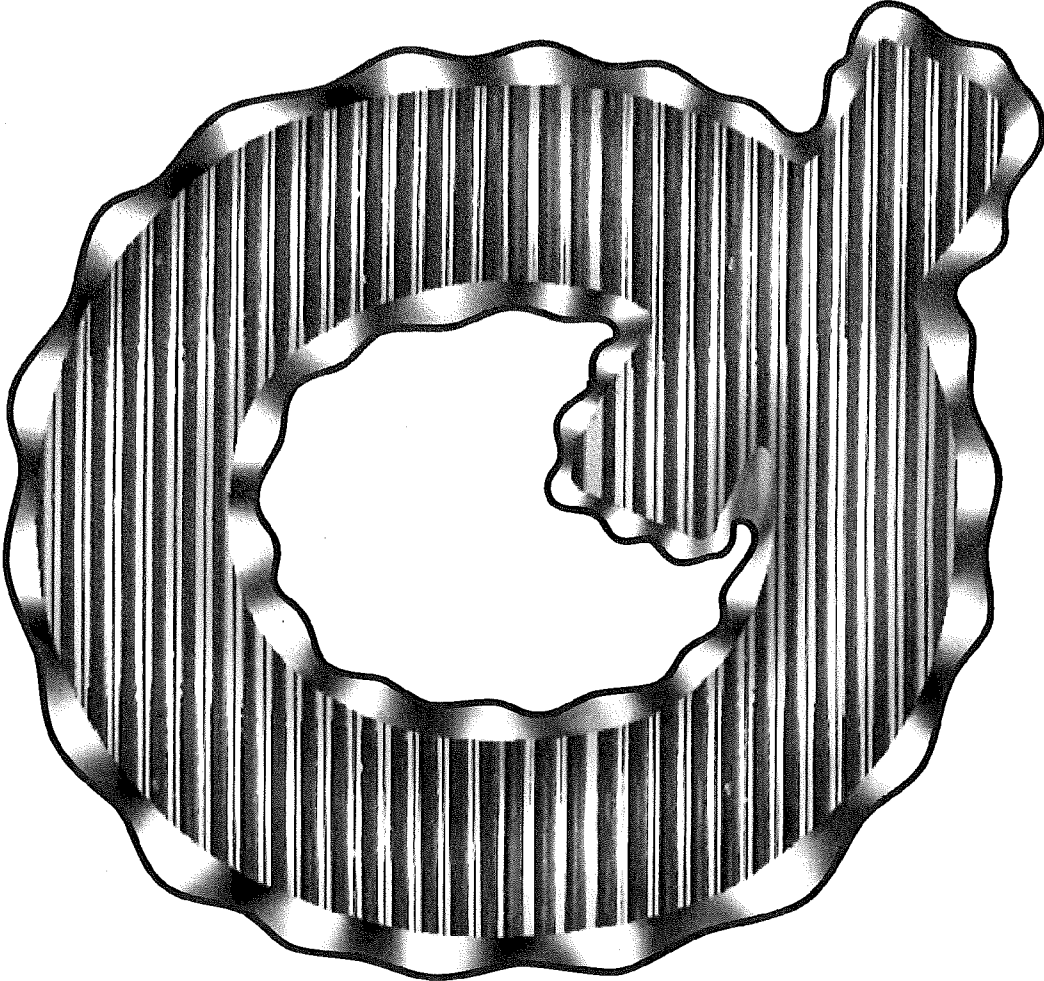

FIG. 18

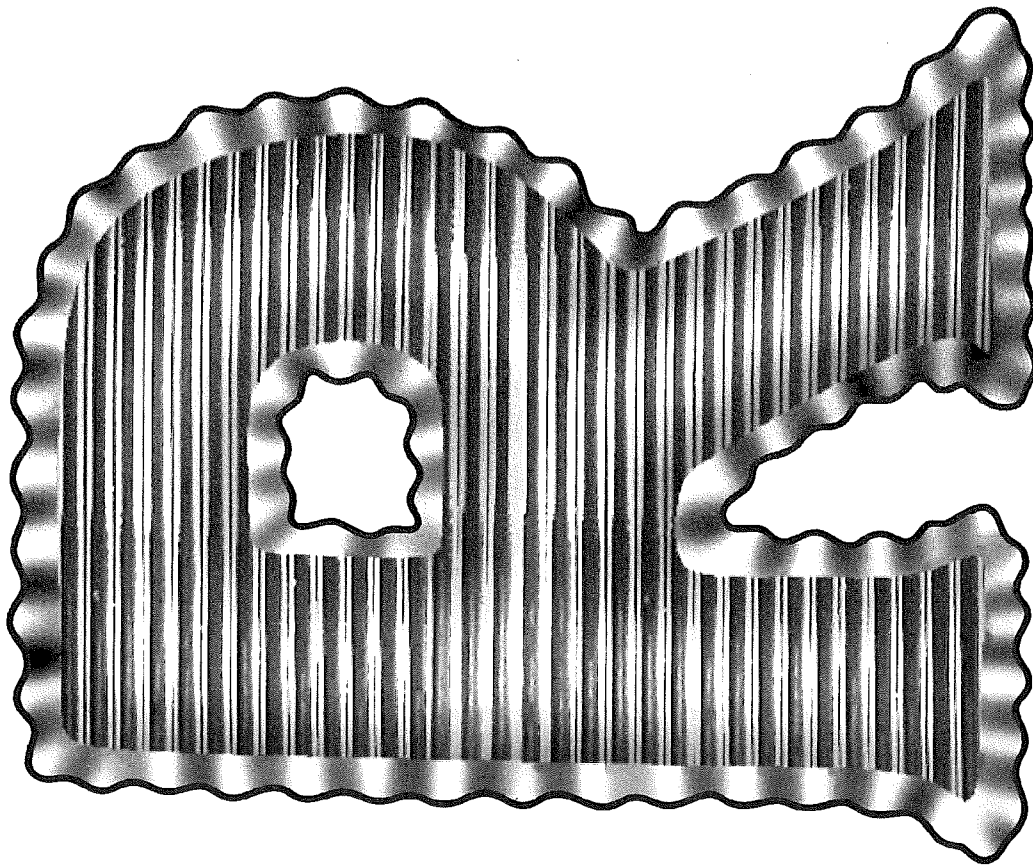

FIG. 19

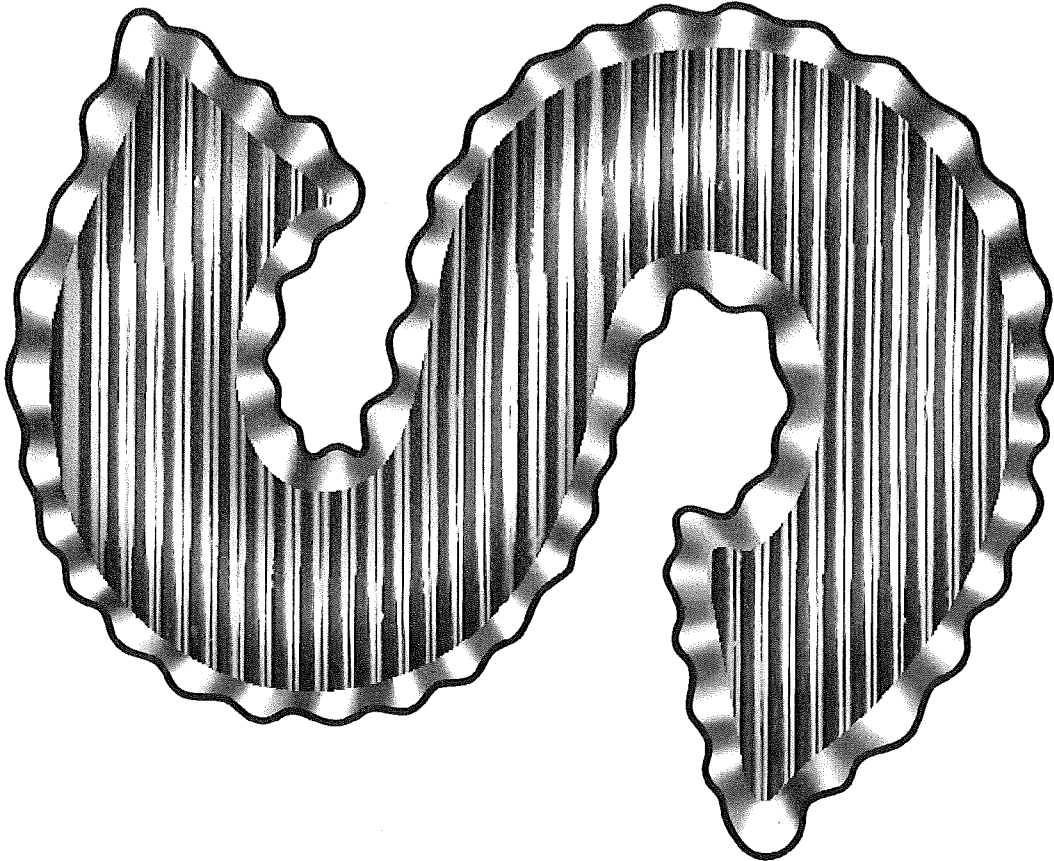

FIG. 20

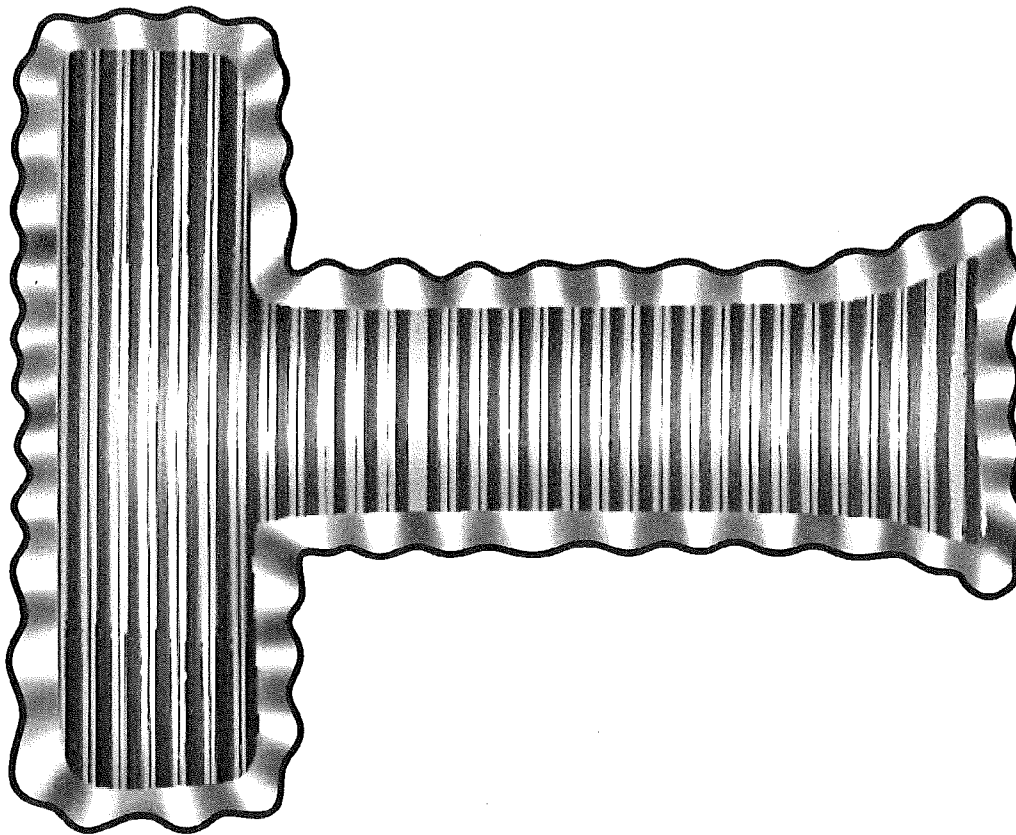

FIG. 21

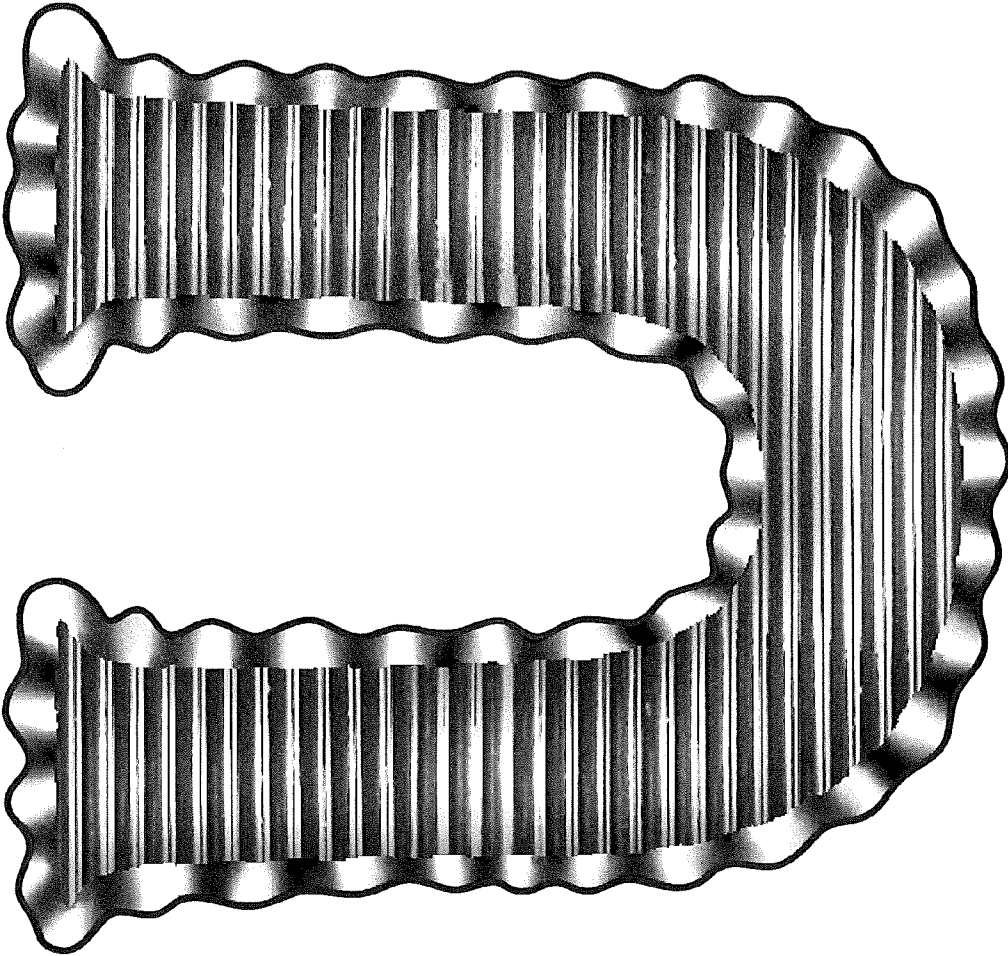

FIG. 22

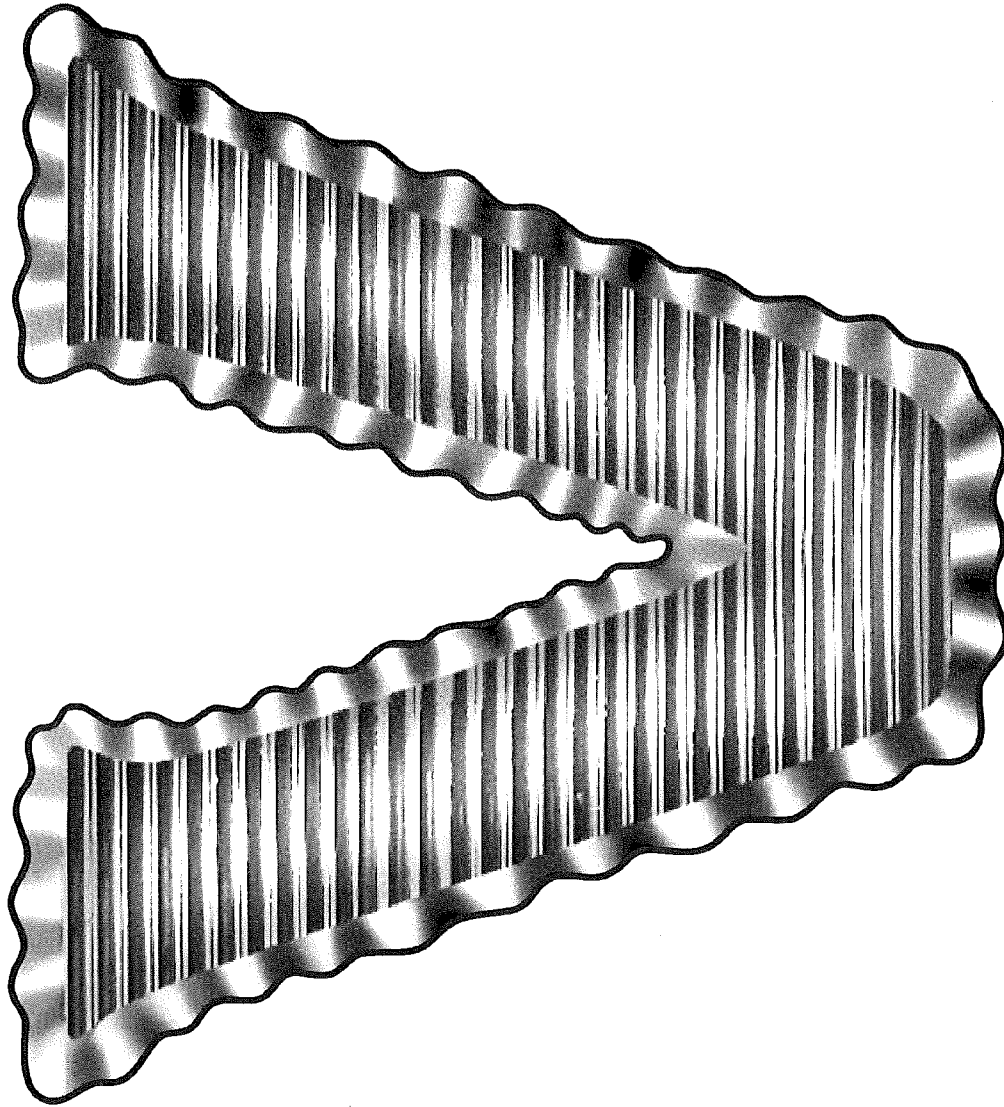

FIG. 23



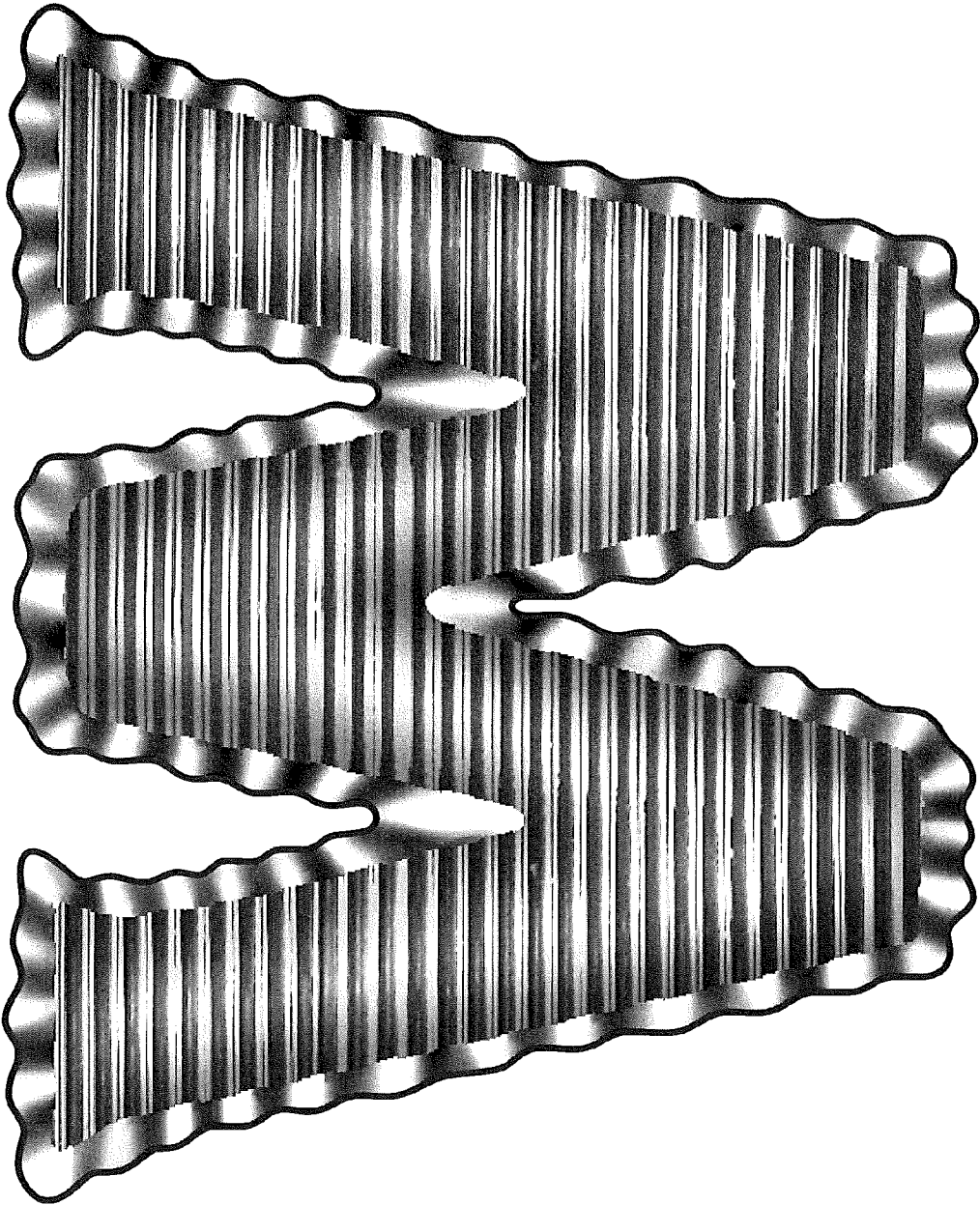

FIG. 24

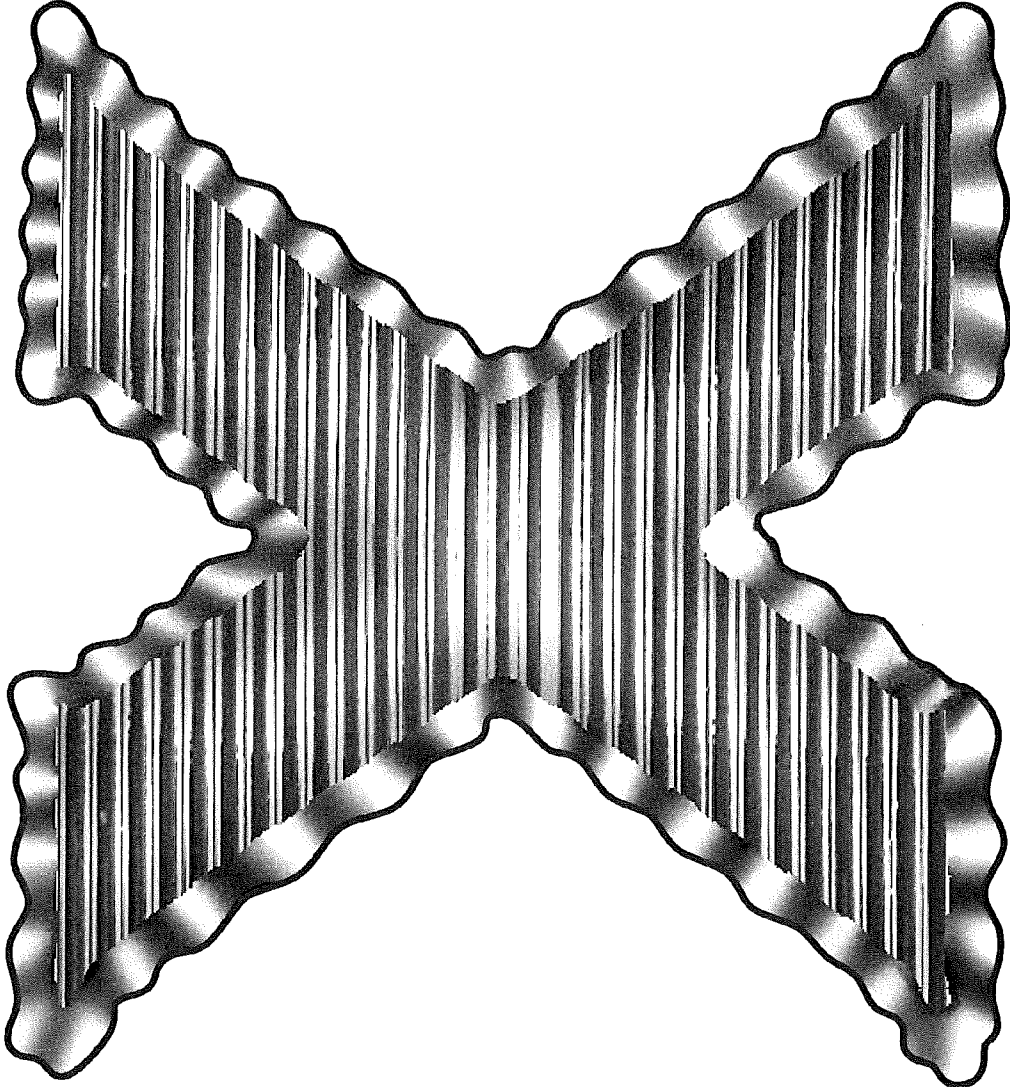

FIG. 25

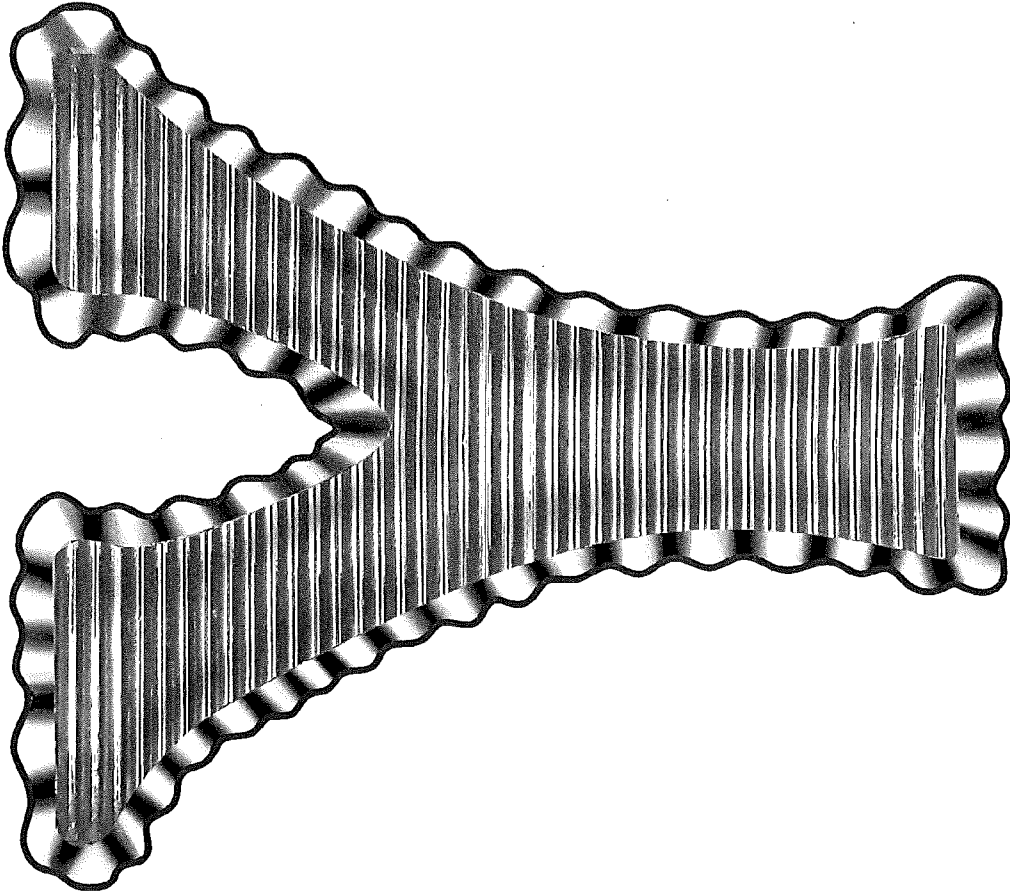

FIG. 26

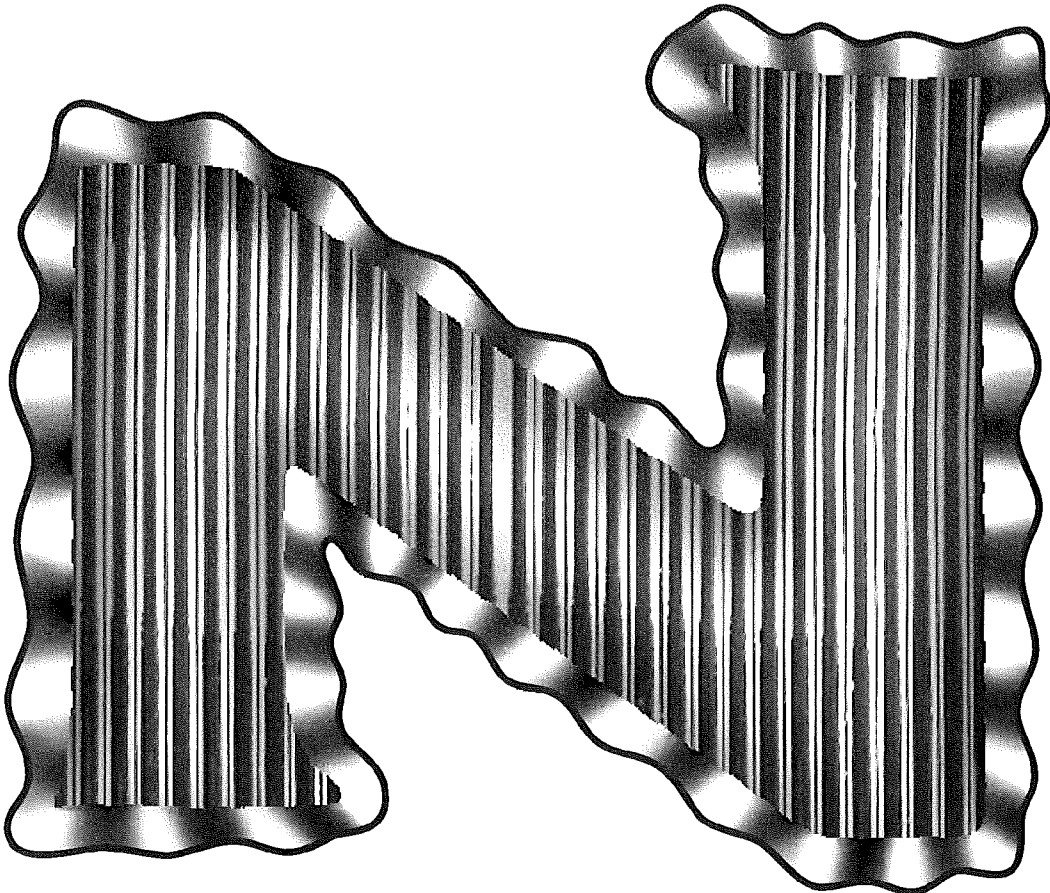

FIG. 27