



US00D824455S

(12) **United States Design Patent**
Inada

(10) **Patent No.:** **US D824,455 S**
(45) **Date of Patent:** **** Jul. 31, 2018**

(54) **PRINTER**

(71) Applicant: **BROTHER INDUSTRIES, LTD.**,
Nagoya-shi, Aichi-ken (JP)

(72) Inventor: **Toshiya Inada**, Nagoya (JP)

(73) Assignee: **BROTHER INDUSTRIES, LTD.**,
Nagoya (JP)

(**) Term: **15 Years**

(21) Appl. No.: **29/579,391**

(22) Filed: **Sep. 29, 2016**

(30) **Foreign Application Priority Data**

Apr. 1, 2016 (JP) 2016-007291

(51) **LOC (11) Cl.** **18-02**

(52) **U.S. Cl.**
USPC **D18/50**

(58) **Field of Classification Search**
USPC D18/50, 53, 55, 36-37, 99; 347/3
CPC B41J 11/58; B41J 15/12; B41J 15/042;
G06K 15/12; G06K 15/14; G03G
21/1633
See application file for complete search history.

(56) **References Cited**

U.S. PATENT DOCUMENTS

D641,038 S * 7/2011 Park D18/55
D641,398 S * 7/2011 Kim D18/55
D643,058 S * 8/2011 Seki D18/55
D722,339 S * 2/2015 Nakagawa D18/55

D749,169 S * 2/2016 Kil D18/55
D749,170 S * 2/2016 Nakagawa D18/55
D749,172 S * 2/2016 Nakagawa D18/55
D765,772 S * 9/2016 Clark, III D18/55
D786,343 S * 5/2017 Kil D18/55
D795,954 S * 8/2017 Hirota D18/55
D800,125 S * 10/2017 Yin D14/422
D803,286 S * 11/2017 Egami D15/148
D805,578 S * 12/2017 Mita D18/55
D806,162 S * 12/2017 Tashima D18/50
D806,791 S * 1/2018 Tashima D18/50
D809,593 S * 2/2018 Tashima D18/50
D810,194 S * 2/2018 Kim D18/50
2008/0014007 A1 * 1/2008 Ukai B41J 29/02
400/691
2017/0185029 A1 * 6/2017 Uohashi G03G 21/1633

* cited by examiner

Primary Examiner — Robin V Webster

Assistant Examiner — James C Thorn, Sr.

(74) *Attorney, Agent, or Firm* — Oliff PLC

(57) **CLAIM**

The ornamental design for a printer, as shown and described.

DESCRIPTION

FIG. 1 is a perspective view of a printer;

FIG. 2 is a front view thereof;

FIG. 3 is a top view thereof;

FIG. 4 is a right-side view thereof;

FIG. 5 is a left-side view thereof;

FIG. 6 is a rear view thereof; and,

FIG. 7 is a bottom view thereof.

The broken lines depict environmental subject matter only and form no part of the claimed design.

1 Claim, 6 Drawing Sheets

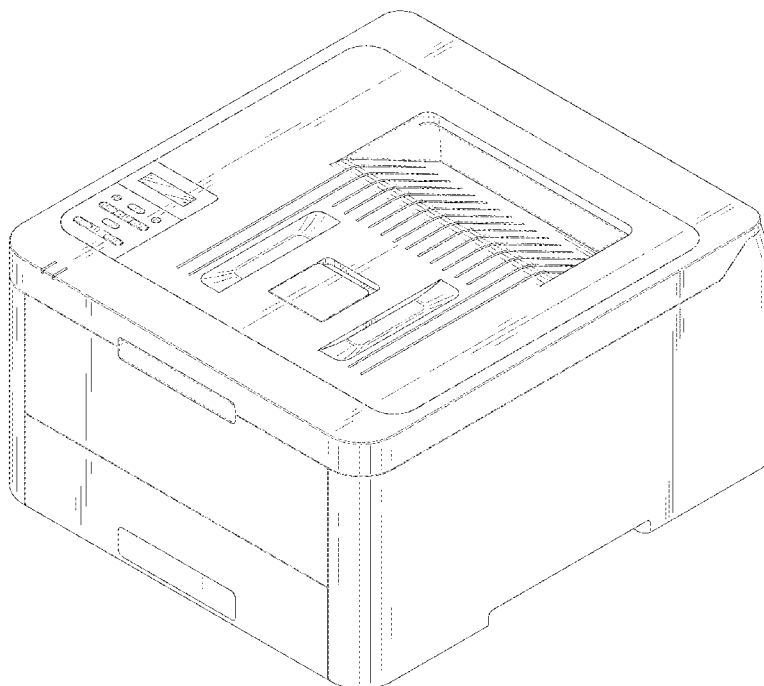

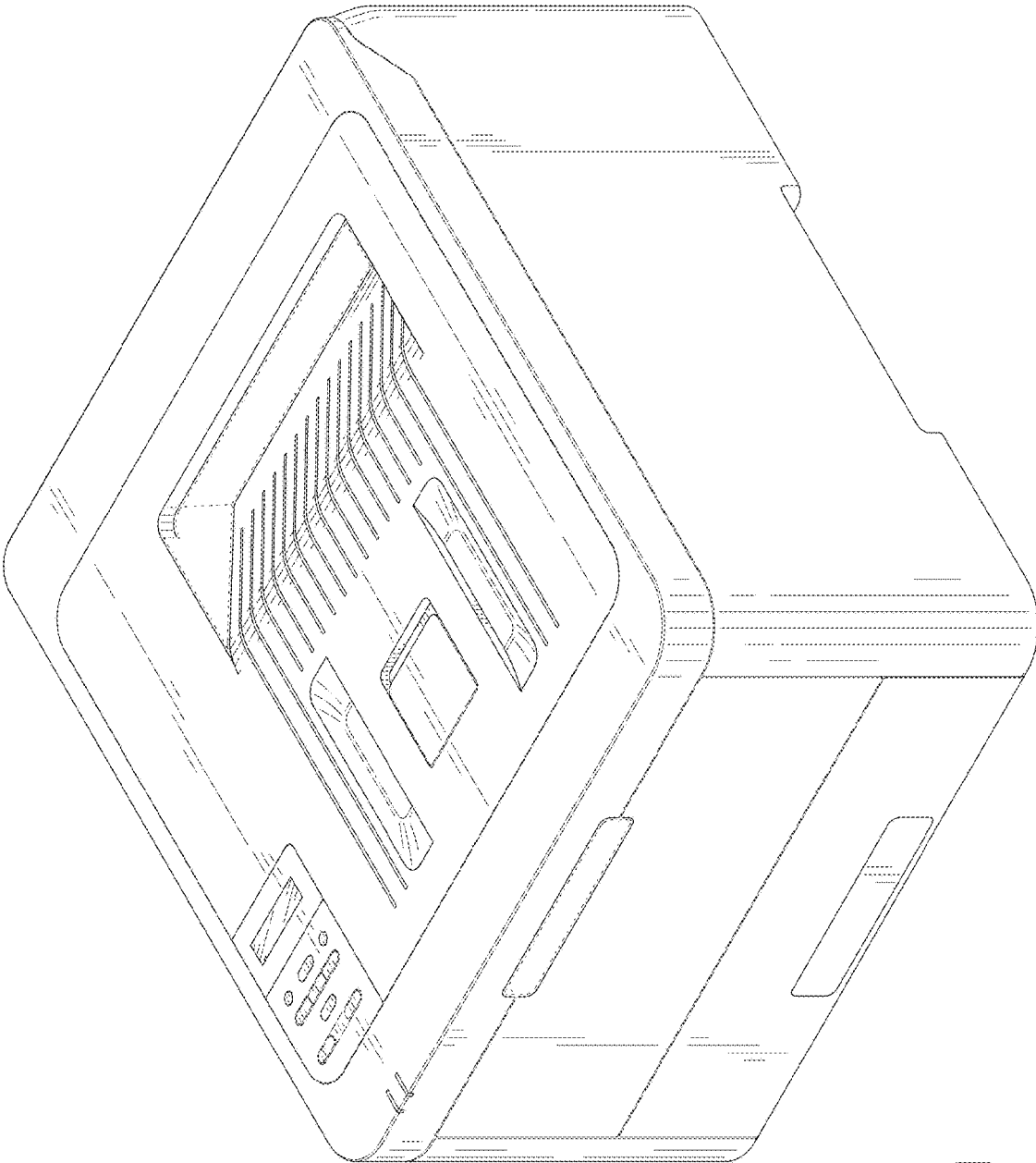

FIG. 1

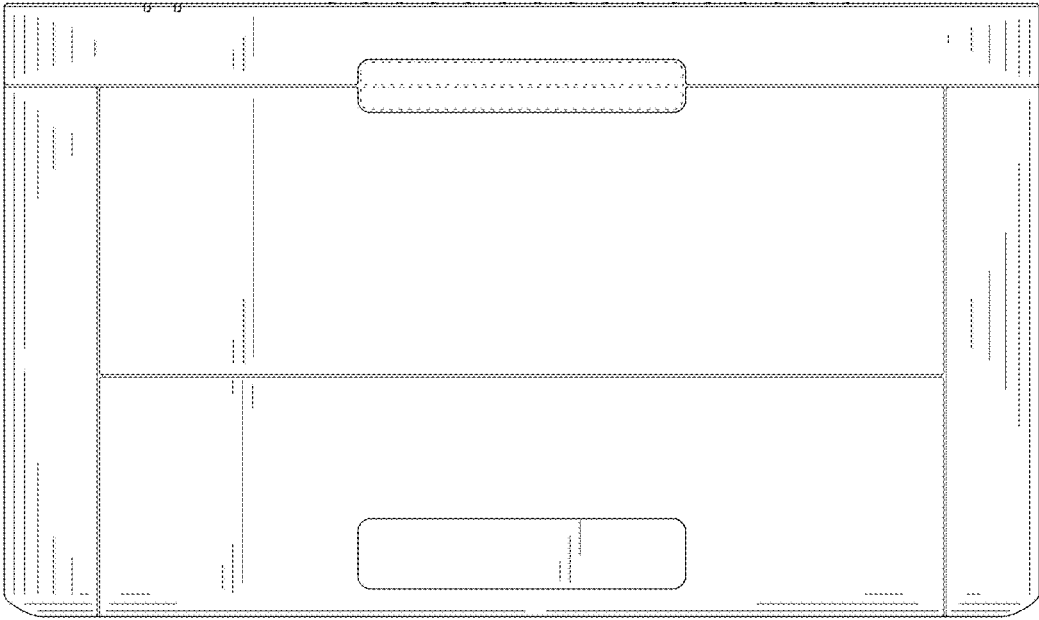

FIG. 2

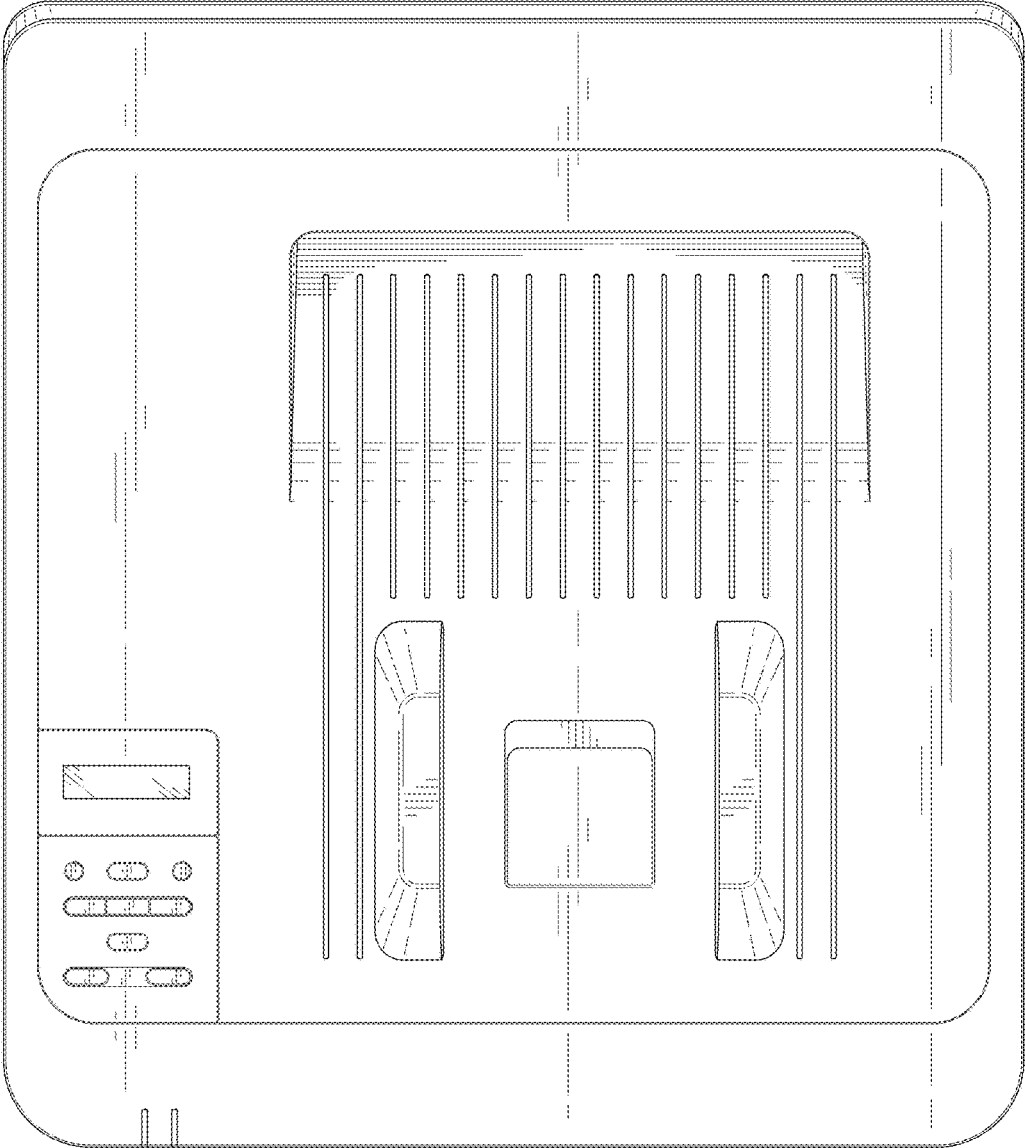

FIG. 3

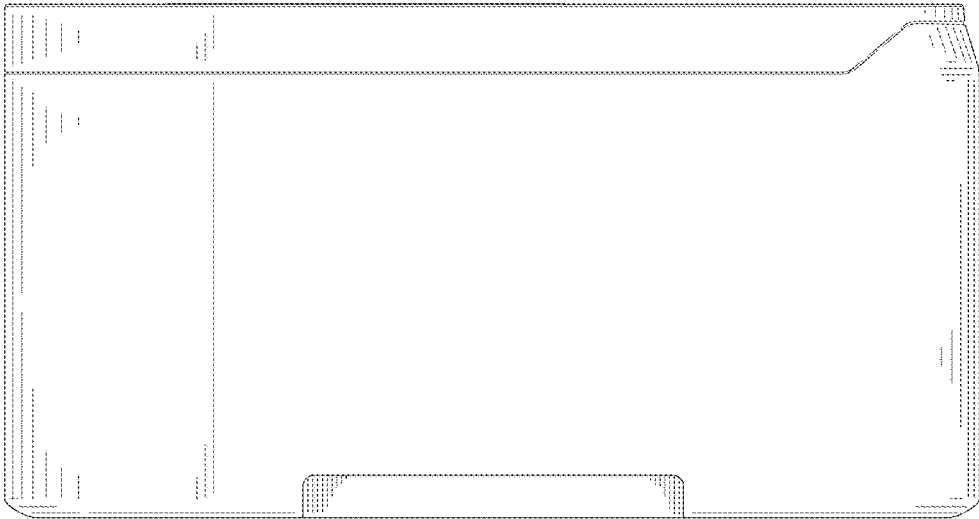

FIG. 4

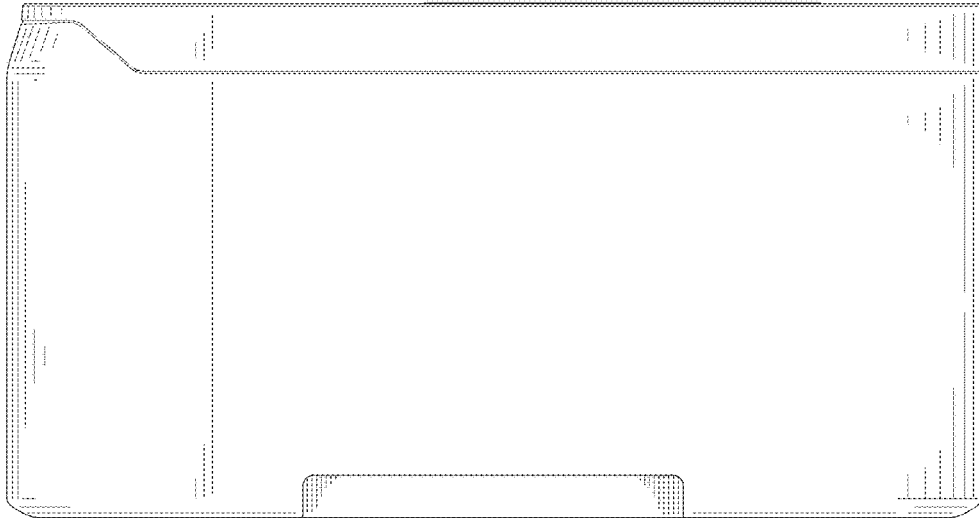

FIG. 5

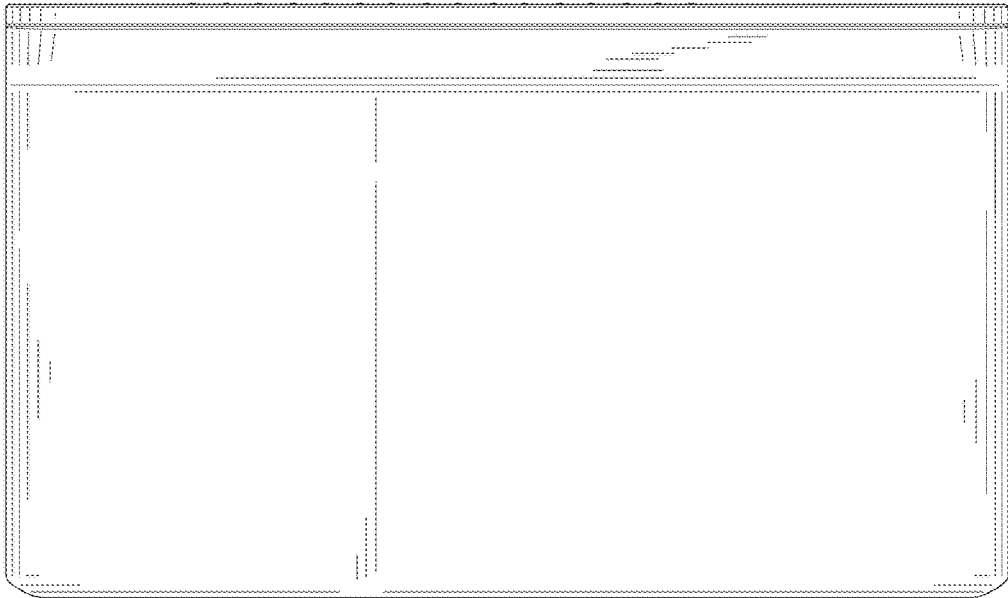

FIG. 6

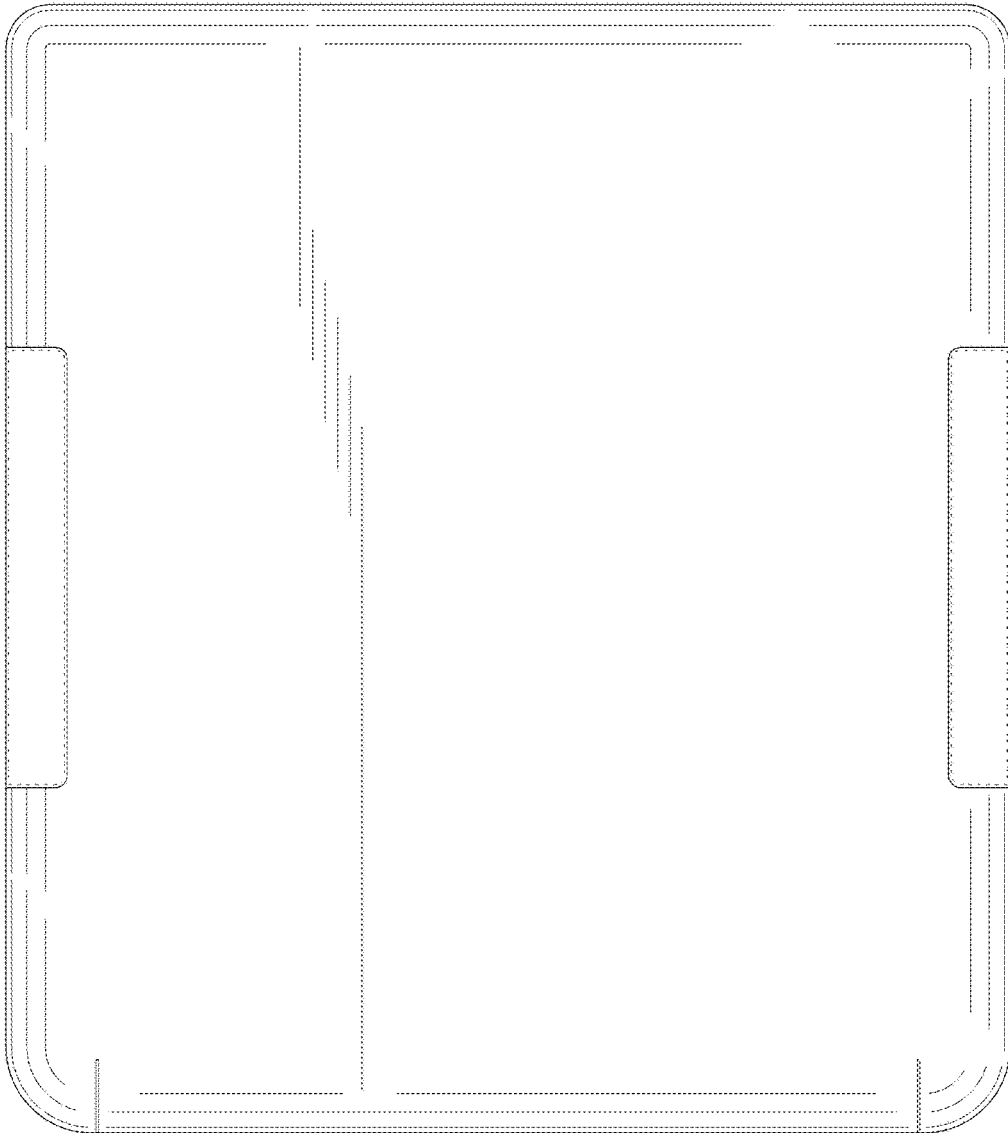

FIG. 7