



US00D853638S

(12) **United States Design Patent**  
**Tappenden et al.**

(10) **Patent No.:** **US D853,638 S**

(45) **Date of Patent:** **\*\* \*Jul. 9, 2019**

(54) **HAIR STYLING AND HAIR CARE APPARATUS**

FOREIGN PATENT DOCUMENTS

(71) Applicant: **Dyson Technology Limited**, Wiltshire (GB)

EM 001066666-0003 1/2009  
JP D678382 5/1986

(Continued)

(72) Inventors: **Benjamin Charles Felix Tappenden**, Bristol (GB); **Britta Jessica Stockinger**, Bath (GB); **Andrea Ee-Va Lim**, Bristol (GB); **Alexander Stuart Knox**, Swindon (GB)

OTHER PUBLICATIONS

“Brushing 1000 Mod. 8090,” Saison Design 1991/1992, Nov. 28, 1991; 2 pages.

(Continued)

(73) Assignee: **Dyson Technology Limited**, Malmesbury, Wiltshire (GB)

*Primary Examiner* — Susan Bennett Hattan

*Assistant Examiner* — Rebecca Tsehaye

(\* ) Notice: This patent is subject to a terminal disclaimer.

(74) *Attorney, Agent, or Firm* — Morrison & Foerster LLP

(\*\*) Term: **15 Years**

(21) Appl. No.: **29/627,741**

(57) **CLAIM**

(22) Filed: **Nov. 29, 2017**

We claim the ornamental design for a hair styling and hair care apparatus, as shown and described.

(30) **Foreign Application Priority Data**

May 30, 2017 (EM) ..... 004024024-0006

(51) **LOC (11) Cl.** ..... **28-03**

(52) **U.S. Cl.**  
USPC ..... **D28/18**

(58) **Field of Classification Search**  
USPC ..... D28/18, 13, 35, 24, 25, 10, 12, 15;  
34/96-98; 132/271; 239/135, 128, 270  
CPC ..... A45D 20/48; A45D 20/50; A45D 20/52;  
A45D 20/525; A45D 20/12; A45D 20/00;  
A45D 20/10; A45D 20/04; A45D 20/08;  
A45D 20/122

See application file for complete search history.

(56) **References Cited**

U.S. PATENT DOCUMENTS

D256,280 S 8/1980 Haase  
D256,846 S 9/1980 Haase

(Continued)

**DESCRIPTION**

The patent or application file contains at least one drawing executed in color. Copies of this patent or patent application publication with color drawings will be provided by the office upon request and payment of the necessary fee.

FIG. 1 is a first side perspective view of a hair styling and hair care apparatus showing our new design;

FIG. 2 is a second side perspective view thereof;

FIG. 3 is a side view thereof;

FIG. 4 is a top view thereof;

FIG. 5 is a bottom view thereof;

FIG. 6 is a front view thereof; and,

FIG. 7 is a rear view thereof.

The view opposite the side view of FIG. 3 is a mirror image thereof, and therefore, is omitted.

**1 Claim, 7 Drawing Sheets**

**(7 of 7 Drawing Sheet(s) Filed in Color)**

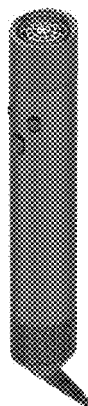

(56)

References Cited

U.S. PATENT DOCUMENTS

4,232,454 A 11/1980 Springer  
 D259,665 S \* 6/1981 Cousins ..... D28/13  
 D277,417 S 1/1985 Wistrand  
 D294,743 S 3/1988 Seki et al.  
 D322,892 S 1/1992 Kwok-Fai Au  
 5,157,757 A 10/1992 McDougall  
 D386,816 S 11/1997 Seifert  
 D398,073 S 9/1998 Kip  
 D398,074 S 9/1998 Nosenchuck  
 D409,796 S 5/1999 Moreno  
 D425,663 S 5/2000 Greubel et al.  
 D439,012 S 3/2001 McCurrach  
 D439,701 S 3/2001 Engelen  
 D448,115 S 9/2001 White  
 D457,730 S 5/2002 McCurrach  
 6,460,272 B2 10/2002 Cheng  
 D476,443 S 6/2003 Ohta et al.  
 6,662,811 B2 12/2003 Mugge et al.  
 D506,030 S 6/2005 Lai  
 D510,192 S 10/2005 Kampel et al.  
 6,962,159 B1 11/2005 Adam  
 7,096,598 B1 8/2006 Myatt  
 D557,017 S 12/2007 Kampel et al.  
 D609,857 S 2/2010 Schmitz  
 D676,600 S 2/2013 Thrasher, Jr.  
 D700,018 S 2/2014 Thrash  
 D754,313 S 4/2016 Ellis et al.  
 D775,418 S 12/2016 Stephens et al.  
 D775,419 S 12/2016 Stephens et al.  
 D776,345 S \* 1/2017 Tang ..... D28/13  
 D782,731 S \* 3/2017 Smith ..... D28/13  
 D782,732 S \* 3/2017 Smith ..... D28/13  
 D782,733 S \* 3/2017 Smith ..... D28/13  
 D782,734 S 3/2017 Sutter et al.  
 D790,785 S 6/2017 Courtney et al.  
 D791,407 S \* 7/2017 Smith ..... D28/13  
 D798,502 S 9/2017 Smith et al.  
 D800,454 S 10/2017 Mathieu  
 9,808,067 B2 \* 11/2017 Sutter ..... A45D 20/10  
 D810,927 S 2/2018 Ross et al.  
 D811,009 S 2/2018 Smith et al.  
 D814,130 S 3/2018 Taub  
 D815,837 S 4/2018 Zhou  
 D817,643 S 5/2018 Valle et al.  
 9,986,810 B2 \* 6/2018 Bobillier ..... A45D 20/08  
 D823,004 S 7/2018 Kuo  
 D823,005 S 7/2018 Kuo  
 10,021,951 B2 \* 7/2018 Bobillier ..... A45D 20/12  
 10,028,574 B2 7/2018 Rennette  
 2014/0083446 A1 3/2014 Julemont et al.  
 2016/0166033 A1 \* 6/2016 Kerr ..... A45D 20/10  
 34/97  
 2016/0166035 A1 \* 6/2016 Douglas ..... A45D 20/12  
 34/97  
 2016/0206075 A1 \* 7/2016 Stephens ..... A45D 20/12  
 2016/0206076 A1 \* 7/2016 Stephens ..... A45D 20/10  
 2016/0206077 A1 \* 7/2016 Stephens ..... A45D 20/12  
 2016/0338464 A1 \* 11/2016 Wilkinson ..... A45D 20/10  
 2016/0338465 A1 \* 11/2016 Wilkinson ..... A45D 20/10  
 2017/0112256 A1 \* 4/2017 Bobillier ..... A45D 20/08  
 2017/0164709 A1 \* 6/2017 Laveni ..... A45D 20/10  
 2017/0273422 A1 9/2017 Heifer et al.  
 2017/0273425 A1 9/2017 Stephens et al.  
 2017/0273428 A1 9/2017 Nicolson et al.  
 2017/0273429 A1 9/2017 Nicolson et al.  
 2017/0273431 A1 9/2017 Courtney et al.  
 2018/0055181 A1 \* 3/2018 Spark ..... A45D 2/24  
 2018/0055184 A1 \* 3/2018 McVeigh ..... A45D 20/12

FOREIGN PATENT DOCUMENTS

JP 63-30902 2/1988  
 JP 63-30903 2/1988

JP D900961 6/1994  
 JP D1001665 1/1998  
 JP D1001666 1/1998

OTHER PUBLICATIONS

“Brushing 1000 Plus, Mod. 8091,” 1995/1996 WIKDESIGN, May 23, 1995; 1 page.  
 “Brushing 1000, Mod. 8090,” 1991/1992 W.I.K. Design, Mar. 2, 1992; 2 pages.  
 Beauty and Health Catalogue 2003 Spring-Summer, Apr. 1, 2003; 2 pages.  
 Coulton et al, U.S. Office Action dated Sep. 14, 2018, directed to U.S. Appl. No. 29/627,694; 9 pages.  
 Coulton et al., U.S. Office Action dated Aug. 31, 2018, directed to U.S. Appl. No. 29/627,665; 8 pages.  
 Coulton et al., U.S. Office Action dated Aug. 8, 2018, directed to U.S. Appl. No. 29/627,693; 9 pages.  
 Coulton et al., U.S. Office Action dated Oct. 30, 2018, directed to U.S. Appl. No. 29/627,739; 7 pages.  
 Coulton et al., U.S. Office Action dated Oct. 30, 2018, directed to U.S. Appl. No. 29/627,749; 7 pages.  
 Coulton et al., U.S. Office Action dated Oct. 30, 2018, directed to U.S. Appl. No. 29/627,752; 7 pages.  
 Coulton et al., U.S. Office Action dated Oct. 30, 2018, directed to U.S. Appl. No. 29/627,754; 7 pages.  
 Coulton et al., U.S. Office Action dated Oct. 30, 2018, directed to U.S. Appl. No. 29/627,773; 8 pages.  
 Coulton et al., U.S. Office Action dated Sep. 10, 2018, directed to U.S. Appl. No. 29/627,690; 7 pages.  
 Coulton et al., U.S. Office Action dated Sep. 14, 2018, directed to U.S. Appl. No. 29/627,707; 9 pages.  
 Heffer et al., U.S. Office Action dated Aug. 16, 2018, directed to U.S. Appl. No. 29/627,688; 8 pages.  
 Heffer et al., U.S. Office Action dated Aug. 16, 2018, directed to U.S. Appl. No. 29/627,712; 8 pages.  
 Heffer et al., U.S. Office Action dated Aug. 16, 2018, directed to U.S. Appl. No. 29/627,713; 8 pages.  
 Heffer et al., U.S. Office Action dated Aug. 16, 2018, directed to U.S. Appl. No. 29/627,730; 8 pages.  
 KRUPS Produkt Programm 1993, Mar. 3, 1993; 2 pages.  
 Mono Magazine, Jul. 2, 1989; 1 page.  
 Tappenden et al., U.S. Office Action dated Oct. 17, 2018, directed to U.S. Appl. No. 29/627,727; 6 pages.  
 Tappenden et al., U.S. Office Action dated Aug. 8, 2018, directed to U.S. Appl. No. 29/627,660; 7 pages.  
 Tappenden et al., U.S. Office Action dated Aug. 8, 2018, directed to U.S. Appl. No. 29/627,664; 7 pages.  
 Tappenden et al., U.S. Office Action dated Aug. 8, 2018, directed to U.S. Appl. No. 29/627,668; 7 pages.  
 Tappenden et al., U.S. Office Action dated Aug. 8, 2018, directed to U.S. Appl. No. 29/627,671; 7 pages.  
 Tappenden et al., U.S. Office Action dated Aug. 8, 2018, directed to U.S. Appl. No. 29/627,673; 7 pages.  
 Tappenden et al., U.S. Office Action dated Aug. 8, 2018, directed to U.S. Appl. No. 29/627,677; 7 pages.  
 Tappenden et al., U.S. Office Action dated Aug. 8, 2018, directed to U.S. Appl. No. 29/627,678; 7 pages.  
 Tappenden et al., U.S. Office Action dated Aug. 8, 2018, directed to U.S. Appl. No. 29/627,714; 7 pages.  
 Tappenden et al., U.S. Office Action dated Nov. 14, 2018, directed to U.S. Appl. No. 29/627,742; 7 pages.  
 Tappenden et al., U.S. Office Action dated Nov. 14, 2018, directed to U.S. Appl. No. 29/627,743; 7 pages.  
 Tappenden et al., U.S. Office Action dated Nov. 14, 2018, directed to U.S. Appl. No. 29/627,744; 7 pages.  
 Tappenden et al., U.S. Office Action dated Oct. 1, 2018, directed to U.S. Appl. No. 29/627,717; 6 pages.  
 Tappenden et al., U.S. Office Action dated Oct. 17, 2018, directed to U.S. Appl. No. 29/627,723; 6 pages.  
 Tappenden et al., U.S. Office Action dated Oct. 17, 2018, directed to U.S. Appl. No. 29/627,731; 6 pages.

(56)

**References Cited**

OTHER PUBLICATIONS

Tappenden et al., U.S. Office Action dated Oct. 17, 2018, directed to U.S. Appl. No. 29/627,733; 6 pages.

Tappenden et al., U.S. Office Action dated Oct. 17, 2018, directed to U.S. Appl. No. 29/627,734; 6 pages.

Tappenden et al., U.S. Office Action dated Oct. 17, 2018, directed to U.S. Appl. No. 29/627,735; 6 pages.

Tappenden et al., U.S. Office Action dated Sep. 27, 2018, directed to U.S. Appl. No. 29/627,700; 6 pages.

Tappenden et al., U.S. Office Action dated Sep. 27, 2018, directed to U.S. Appl. No. 29/627,702; 6 pages.

Tappenden et al., U.S. Office Action dated Sep. 27, 2018, directed to U.S. Appl. No. 29/627,705; 6 pages.

Tappenden et al., U.S. Office Action dated Sep. 27, 2018, directed to U.S. Appl. No. 29/627,706; 6 pages.

Tappenden et al., U.S. Office Action dated Sep. 27, 2018, directed to U.S. Appl. No. 29/627,710; 6 pages.

Tappenden et al., U.S. Office Action dated Sep. 27, 2018, directed to U.S. Appl. No. 29/627,724; 6 pages.

Tappenden et al., U.S. Office Action dated Sep. 27, 2018, directed to U.S. Appl. No. 29/627,725; 6 pages.

Tappenden et al., U.S. Office Action dated Sep. 27, 2018, directed to U.S. Appl. No. 29/627,726; 6 pages.

Tappenden et al., U.S. Office Action dated Sep. 28, 2018, directed to U.S. Appl. No. 29/627,719; 6 pages.

\* cited by examiner

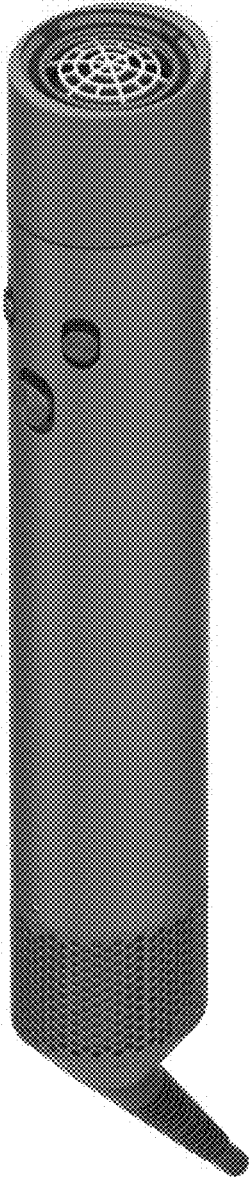

FIG. 1

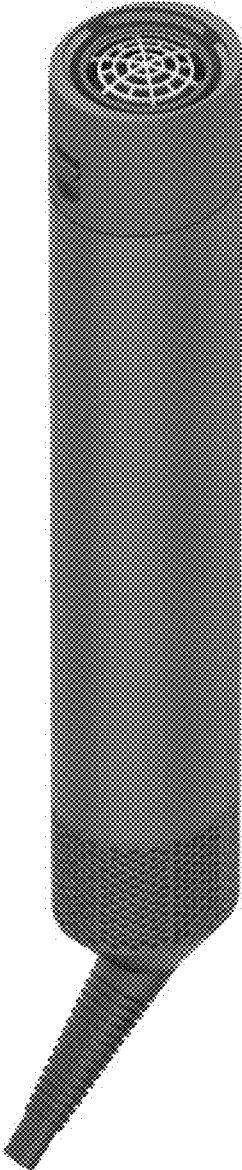

FIG. 2

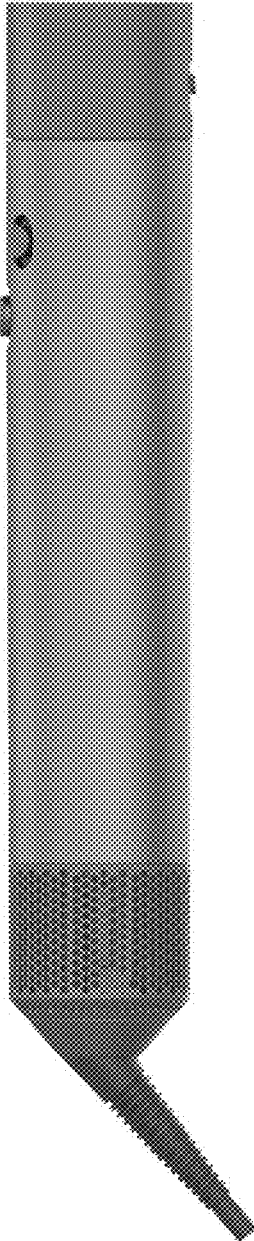

FIG. 3

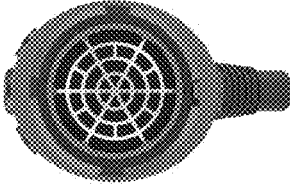

FIG. 4

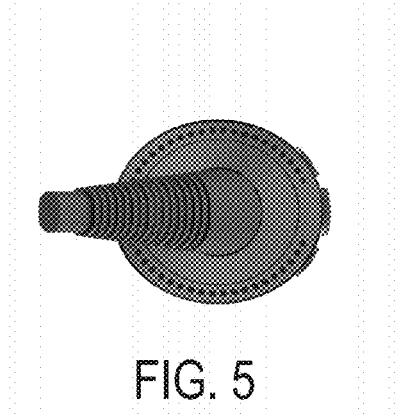

FIG. 5



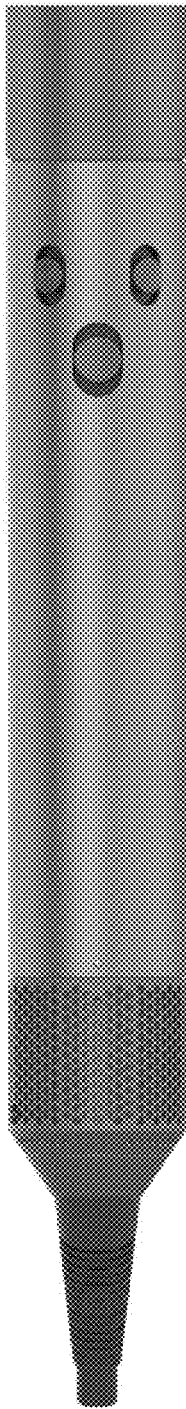

FIG. 6

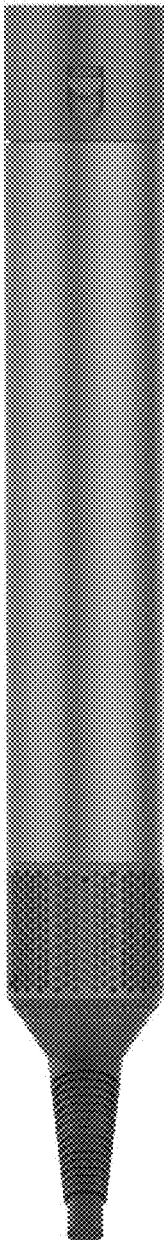

FIG. 7