



US00D366056S

United States Patent [19]

[11] Patent Number: Des. 366,056

Wolfe

[45] Date of Patent: **Jan. 9, 1996

[54] SUNGLASSES

[76] Inventor: **Winston Wolfe**, 4749 Oakbrook Ct.,
Memphis, Tenn. 38117

[**] Term: **14 Years**

[21] Appl. No.: **32,253**

[22] Filed: **Dec. 12, 1994**

[52] U.S. Cl. **D16/314**

[58] **Field of Search** D16/300, 301,
D16/306, 307, 311, 312, 313, 314, 323-327,
341, 342, 900; 351/44, 47, 51, 52, 59, 103-107,
111, 118-122, 158; 2/432, 439, 447, 453

[56] References Cited

U.S. PATENT DOCUMENTS

- D. 163,869 7/1951 Hinman .
- D. 176,316 12/1955 Fleming .
- D. 178,178 7/1956 Fleming .
- D. 199,150 9/1964 Carmichael .
- D. 285,020 8/1986 Schmidthaler .
- D. 293,450 12/1987 Jannard .
- D. 322,081 12/1991 Longsdorf D16/314
- D. 329,442 9/1992 Jannard D16/314
- D. 329,445 9/1992 Jannard .
- D. 331,587 12/1992 Jannard et al. .
- D. 336,097 6/1993 Wiedner D16/325
- 2,444,498 7/1948 Cochran .
- 2,472,731 6/1949 Splaine .
- 3,233,249 2/1966 Baratelli et al. .
- 3,233,250 2/1966 Jonassen .

- 4,515,448 5/1985 Tackles .
- 4,674,851 6/1987 Jannard .
- 4,730,915 3/1988 Jannard .
- 4,741,611 5/1988 Burns 351/44
- 4,824,233 8/1989 Jannard .
- 4,859,048 8/1989 Jannard .
- 4,867,550 9/1989 Jannard .
- 5,347,323 9/1994 Wilson 351/47
- 5,381,192 1/1995 Canavan et al. 351/111

OTHER PUBLICATIONS

Nikon Sunglasses Catalog 1989 p. 5 top of page.

Primary Examiner—Ted Shooman

Assistant Examiner—R. Barkai

Attorney, Agent, or Firm—Rothwell, Figg, Ernst & Kurz

[57] CLAIM

The ornamental design for sunglasses, as shown and described.

DESCRIPTION

FIG. 1 is front perspective view of the sunglasses showing my new design;
 FIG. 2 is a side elevation view thereof, the opposite being a mirror image thereof;
 FIG. 3 is a top plan view;
 FIG. 4 is a bottom plan view;
 FIG. 5 is a front elevation view; and,
 FIG. 6 is a rear elevation view.

1 Claim, 5 Drawing Sheets

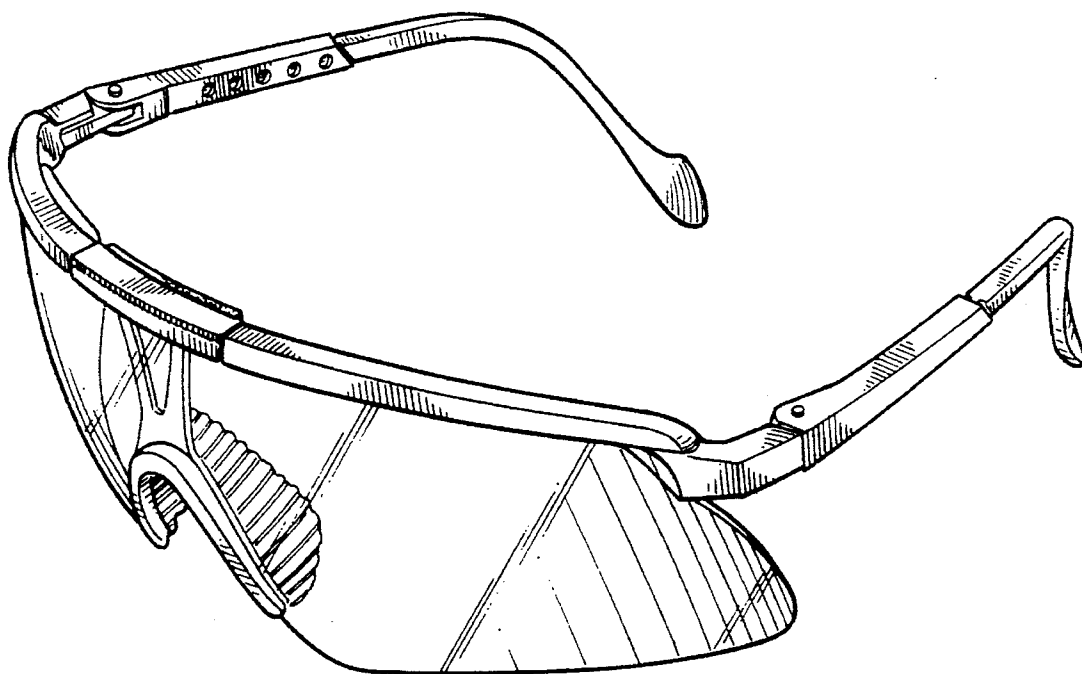

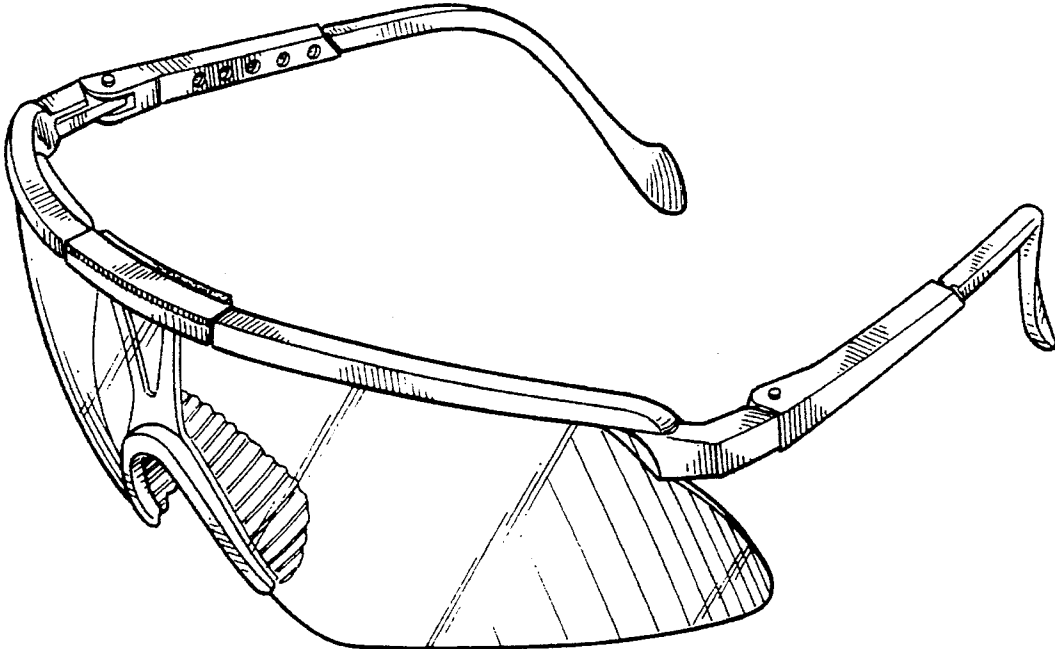

FIG. 1

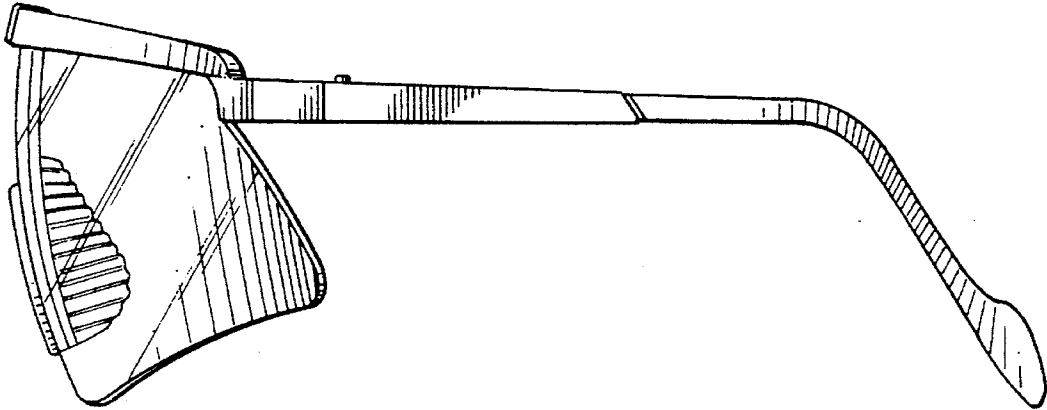

FIG. 2

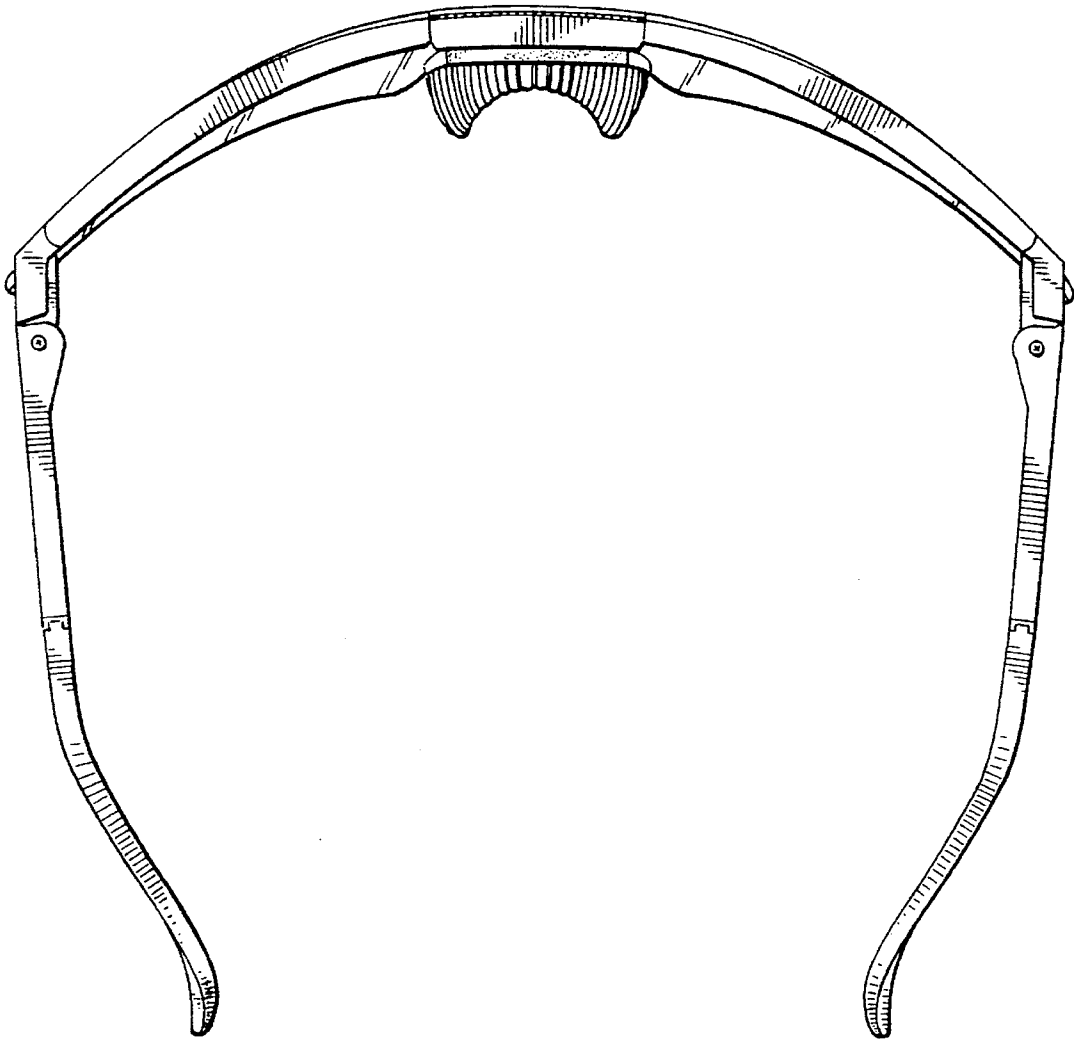

FIG. 3

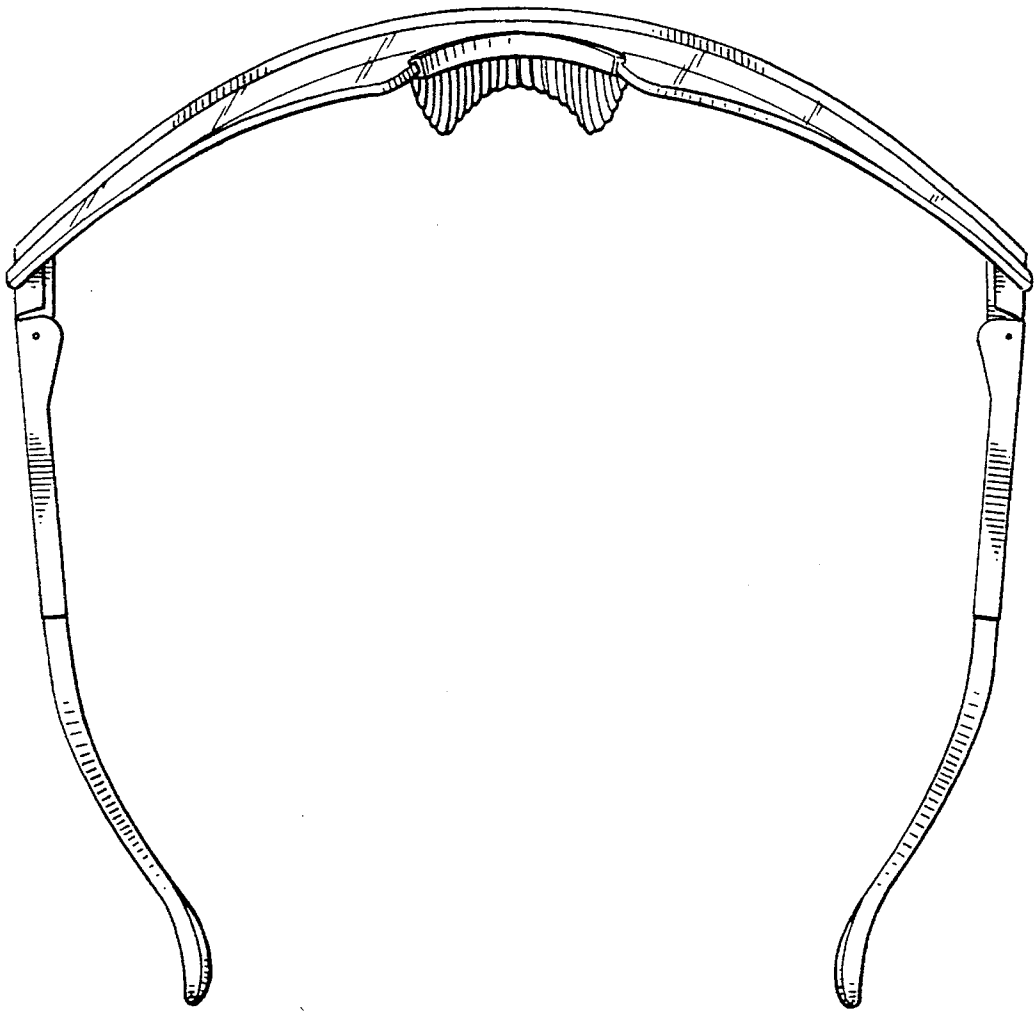

FIG. 4

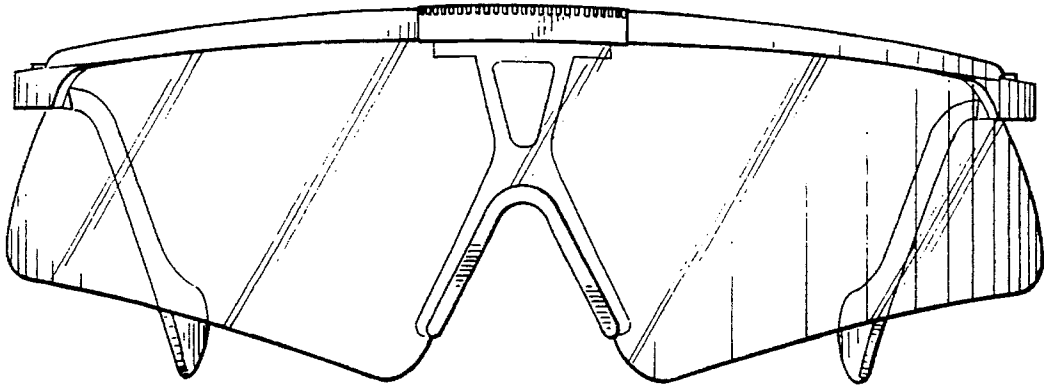

FIG. 5

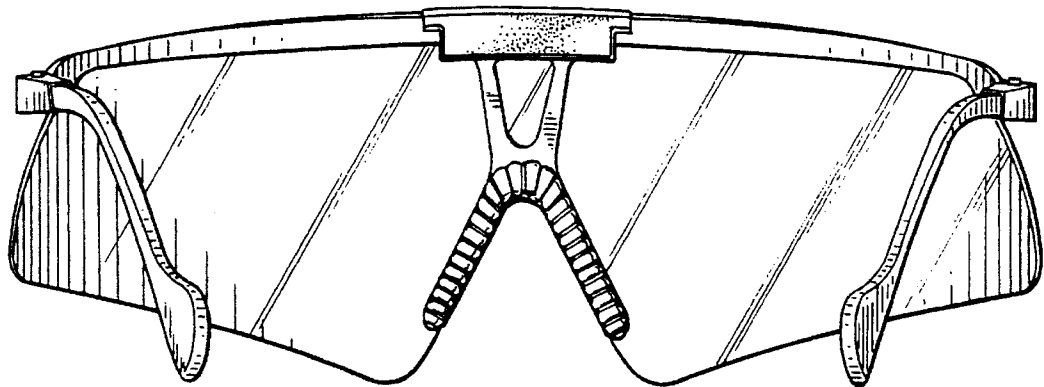

FIG. 6