



US00D425978S

**United States Patent** [19]  
**Cunning**

[11] **Patent Number: Des. 425,978**

[45] **Date of Patent: \*\* \*May 30, 2000**

[54] **WINDOW FAN**

[75] Inventor: **Joseph M. Cunning**, Cohasset, Mass.

[73] Assignee: **Holmes Product Corp.**, Milford, Mass.

[\*] Notice: This patent is subject to a terminal disclaimer.

[\*\*] Term: **14 Years**

[21] Appl. No.: **29/099,270**

[22] Filed: **Feb. 4, 1998**

**Related U.S. Application Data**

[63] Continuation of application No. 29/004,825, Feb. 16, 1993, abandoned.

[51] **LOC (7) Cl.** ..... **23-04**

[52] **U.S. Cl.** ..... **D23/370; D23/353**

[58] **Field of Search** ..... **D23/370, 351, D23/353, 354; 416/244 R; 454/210, 208, 201**

[56] **References Cited**

**U.S. PATENT DOCUMENTS**

D. 329,283	9/1992	Maiellano, Jr. et al. ....	D23/353
2,456,391	12/1948	Davies .....	416/244 R
3,275,224	9/1966	Bush .....	416/246

*Primary Examiner*—Lisa Lichtenstein  
*Attorney, Agent, or Firm*—Hoffmann & Baron, LLP;  
Francis E. Marino

**CLAIM**

[57]

The ornamental design for a window fan, as shown.

**DESCRIPTION**

FIG. 1 is a front, left, perspective view of a window fan showing my new design;

FIG. 2 is a front elevational view thereof;

FIG. 3 is a rear elevational view thereof;

FIG. 4 is a right side elevational view thereof;

FIG. 5 is a left side elevational view thereof;

FIG. 6 is a top plan view thereof; and,

FIG. 7 is a bottom plan view thereof.

**1 Claim, 6 Drawing Sheets**

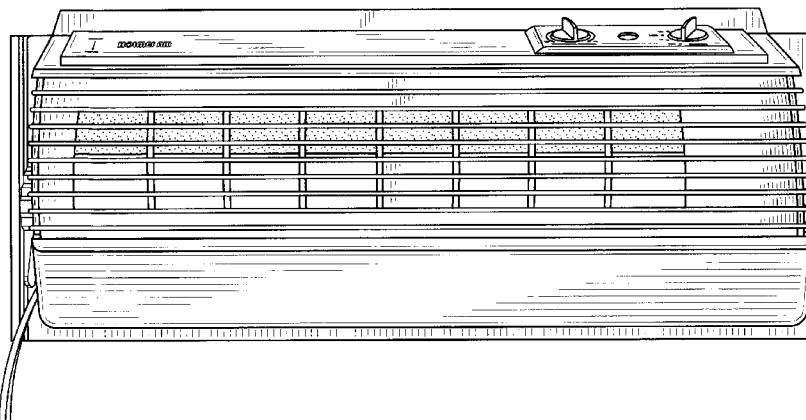
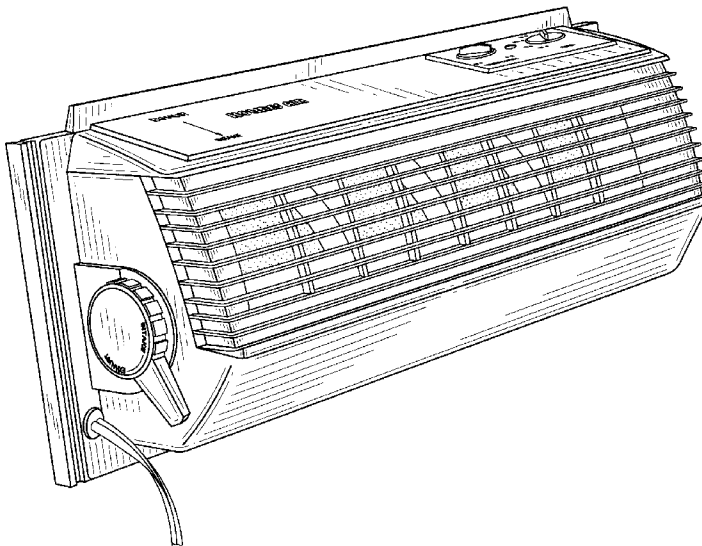

FIG-1

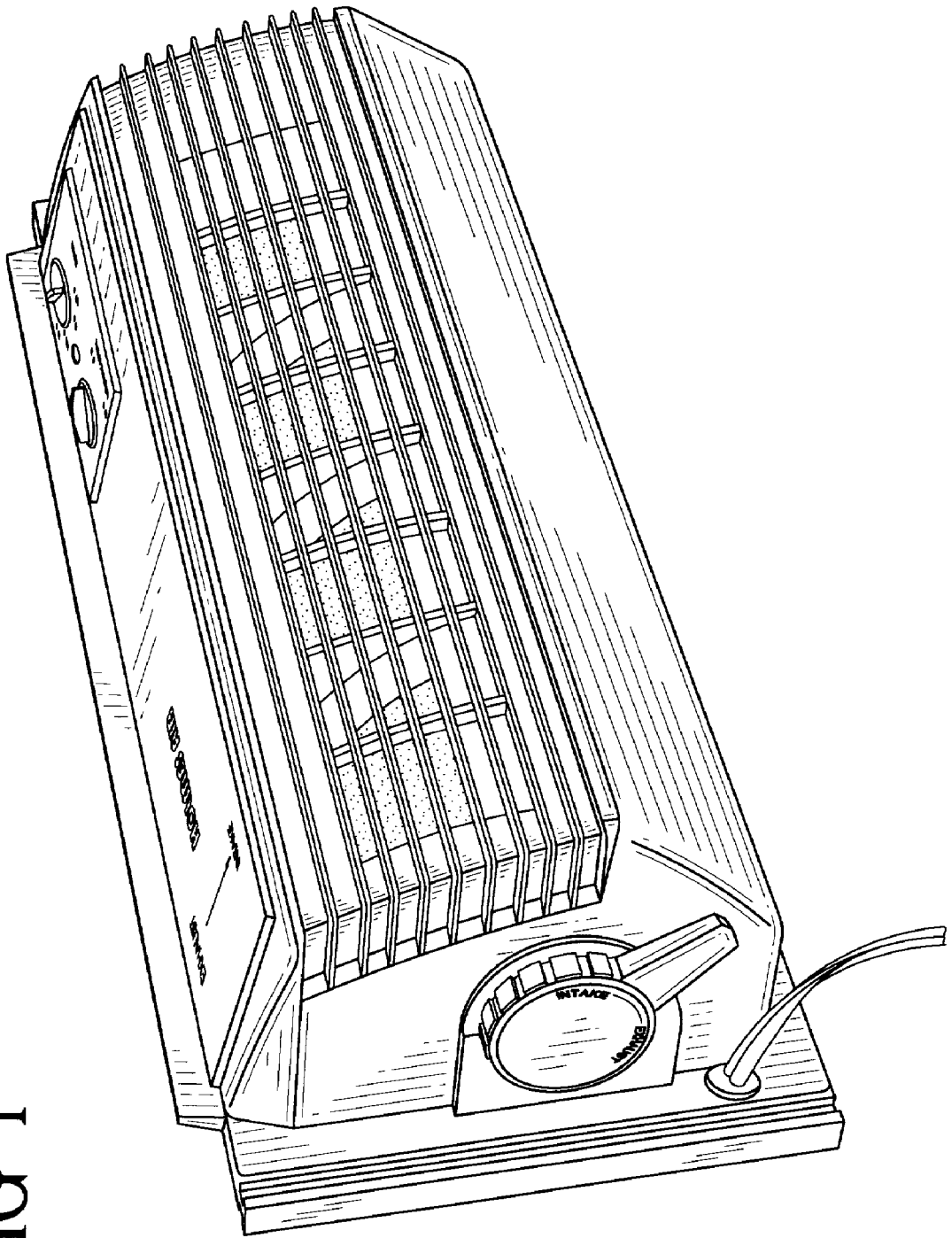

FIG-2

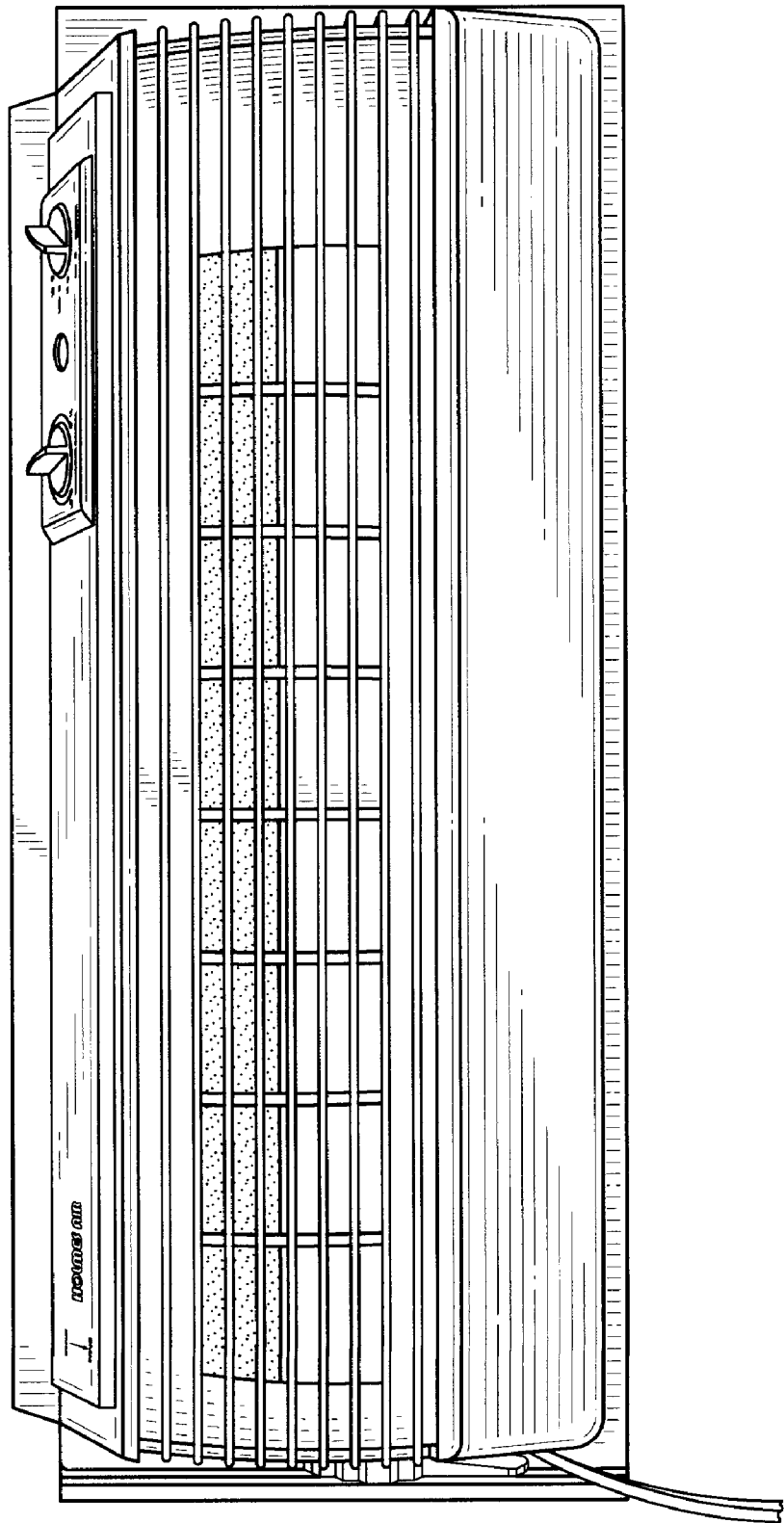

FIG-3

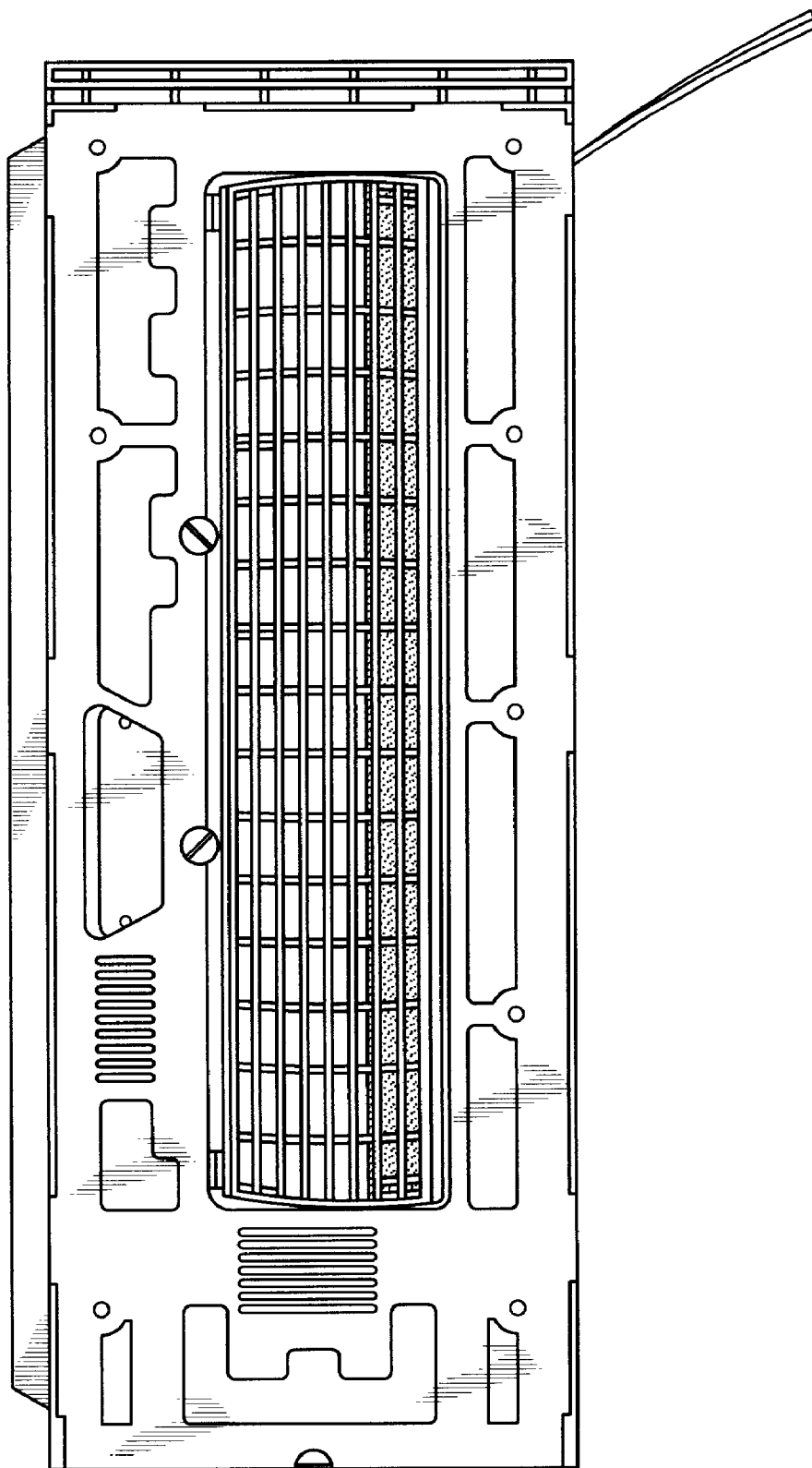

FIG-5

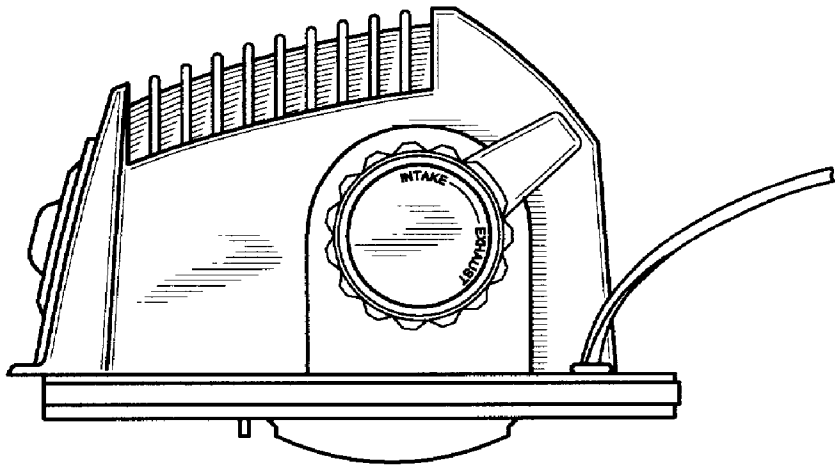

FIG-4

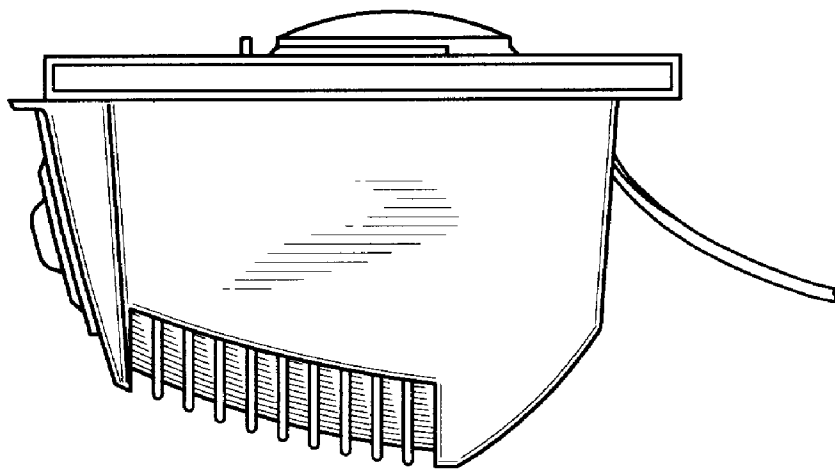

FIG-6

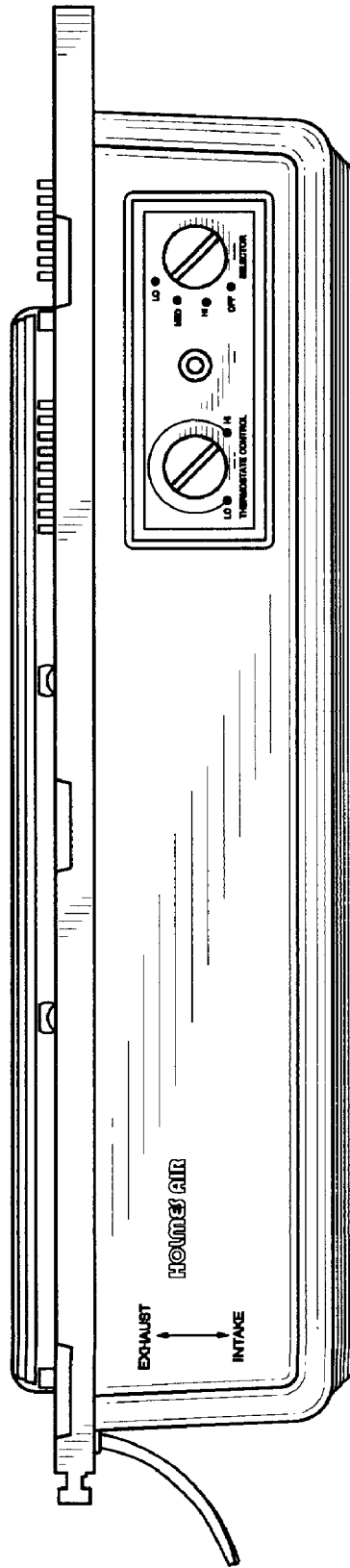

FIG-7

