



US00D404027S

United States Patent [19]
Bush

[11] **Patent Number: Des. 404,027**
[45] **Date of Patent: **Jan. 12, 1999**

[54] **MOUSE FOR A PERSONAL COMPUTER**

[76] Inventor: **David W. Bush**, 2008 E. Riverside Dr.,
Evansville, Ind. 47714

[**] Term: **14 Years**

[21] Appl. No.: **73,643**

[22] Filed: **Jul. 1, 1997**

Related U.S. Application Data

[63] Continuation-in-part of Ser. No. 66,462, Feb. 12, 1997,
abandoned.

[51] **LOC (6) Cl.** **14-02**

[52] **U.S. Cl.** **D14/114**

[58] **Field of Search** D14/100, 114;
D13/158; D21/48; 200/5 R, 5 A, 6 R, 6 A;
273/148 B; 345/156-67; 74/471 Y; D12/82-100

[56] **References Cited**

U.S. PATENT DOCUMENTS

D. 374,001	9/1996	Vance	D14/114
D. 386,160	11/1997	Young	D14/114
D. 386,164	11/1997	Silberstein	D14/114
D. 386,484	11/1997	Jensen et al.	D14/114
D. 387,338	12/1997	Leifer	D14/114
D. 387,748	12/1997	Martella	D14/114
D. 387,749	12/1997	Diaz	D14/114
D. 390,210	2/1998	Bickford et al.	D14/114
5,245,146	9/1993	Florence	200/333

OTHER PUBLICATIONS

ERTL Company, Inc. product information sheet, Stock No.
8106, Form No. 099-8106, Mello Yello, 1991.

Primary Examiner—M. H. Tung

Attorney, Agent, or Firm—Woodard, Emhardt, Naughton,
Moriarty & McNett

[57] **CLAIM**

The ornamental design for a mouse for a personal computer,
as shown and described.

DESCRIPTION

FIG. 1 is a perspective view of a mouse for a personal computer, showing a first embodiment of my new design; FIG. 2 is a front elevational view; FIG. 3 is a rear elevational view; FIG. 4 is a top plan view; FIG. 5 is a left-side elevational view; FIG. 6 is a right-side elevational view; FIG. 7 is a perspective view of a mouse for a personal computer, showing a second embodiment of my new design; FIG. 8 is a front elevational view; FIG. 9 is a rear elevational view; FIG. 10 is a top plan view; FIG. 11 is a left-side elevational view; FIG. 12 is a right-side elevational view; FIG. 13 is a perspective view of a mouse for a personal computer, showing a third embodiment of my new design; FIG. 14 is a front elevational view; FIG. 15 is a rear elevational view; FIG. 16 is a top plan view; FIG. 17 is a left-side elevational view; FIG. 18 is a right-side elevational view; FIG. 19 is a perspective view of a mouse for a personal computer, showing a fourth embodiment of my new design; FIG. 20 is a front elevational view; FIG. 21 is a rear elevational view; FIG. 22 is a top plan view; FIG. 23 is a left-side elevational view; and, FIG. 24 is a right-side elevational view.

1 Claim, 16 Drawing Sheets

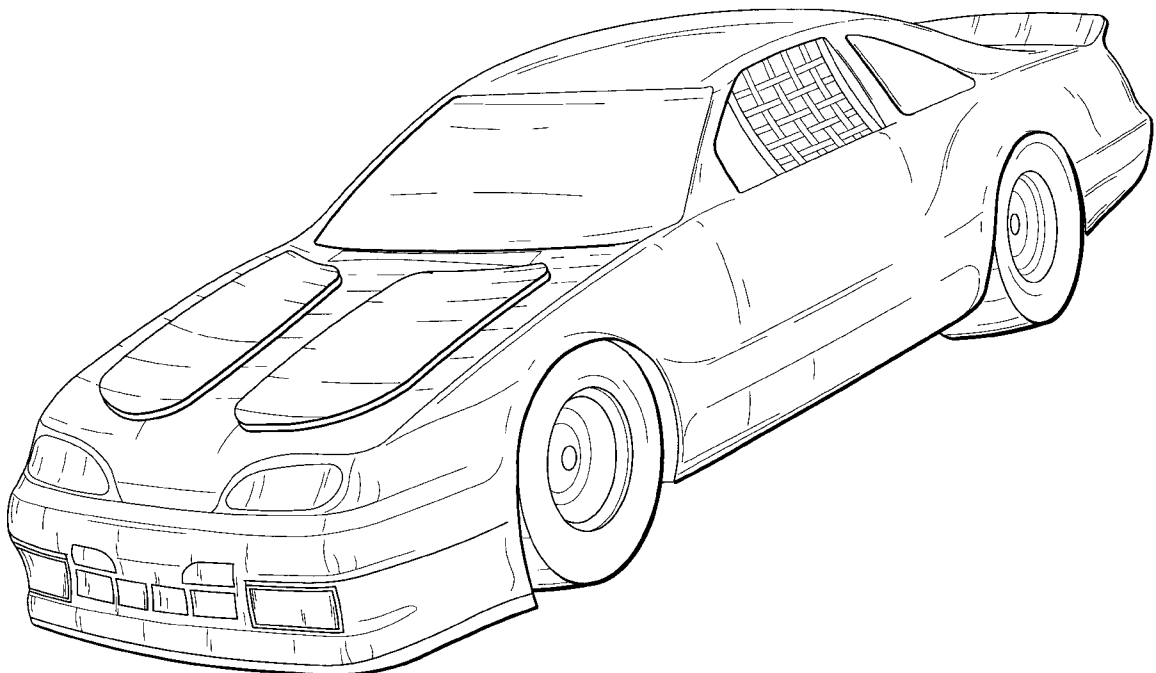

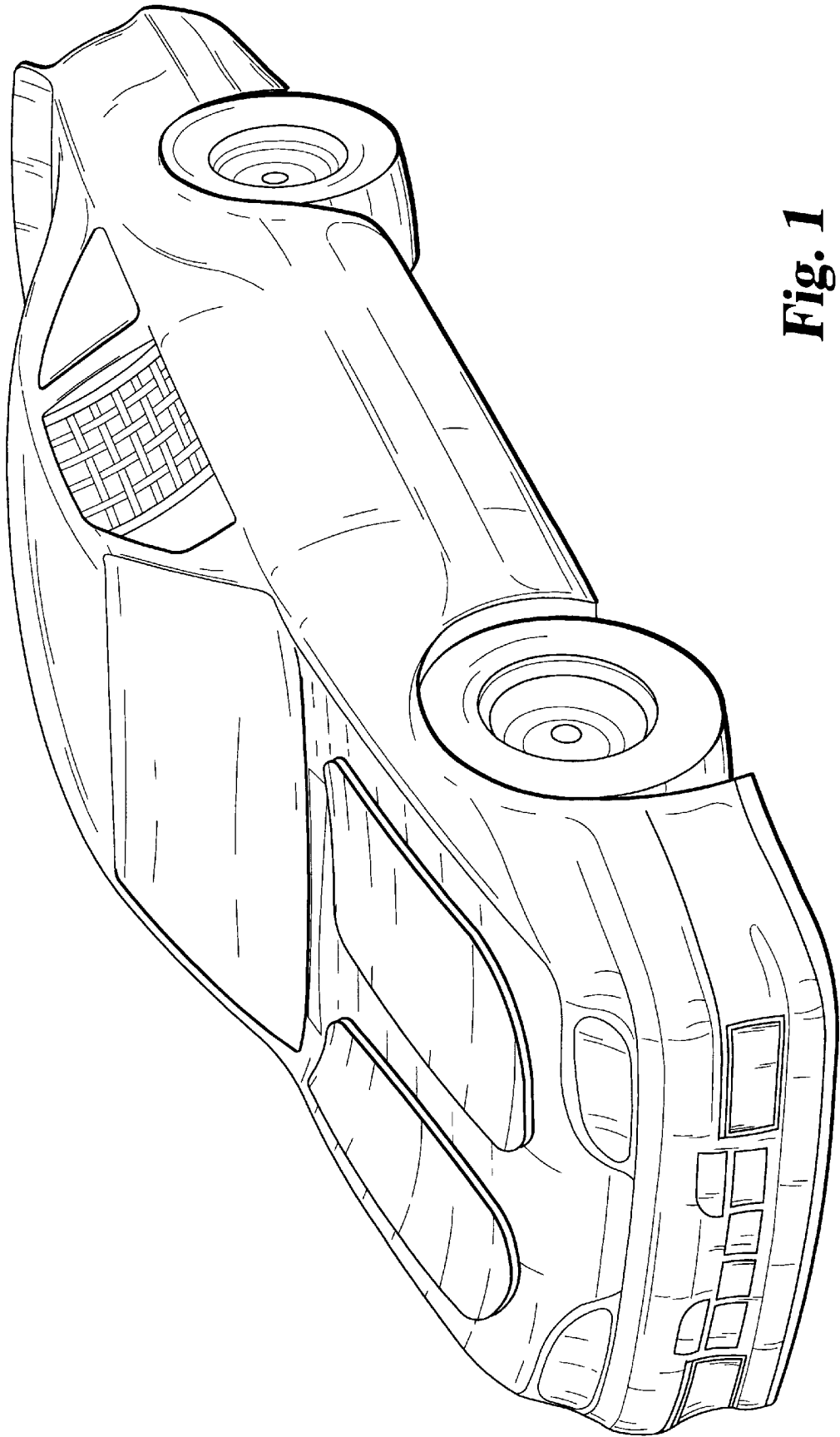

Fig. 1

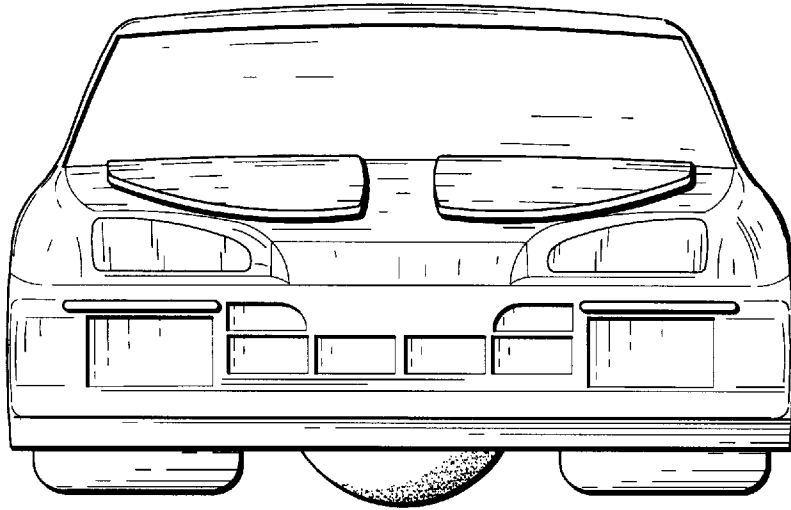

Fig. 2

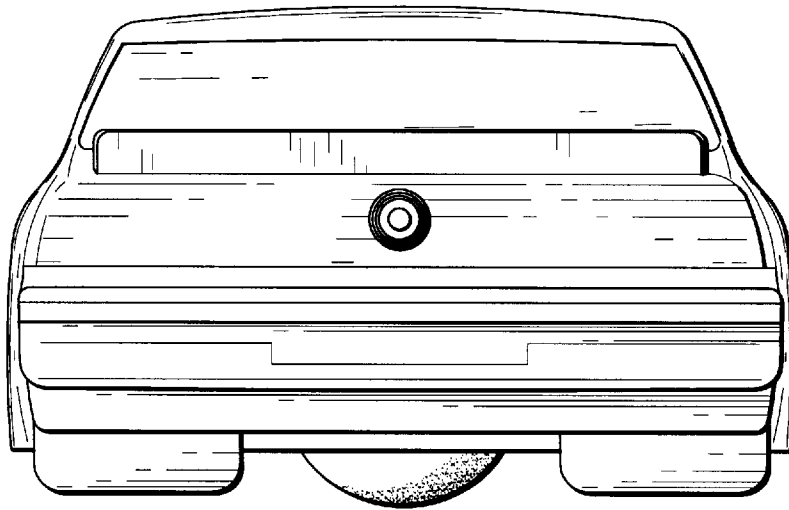

Fig. 3

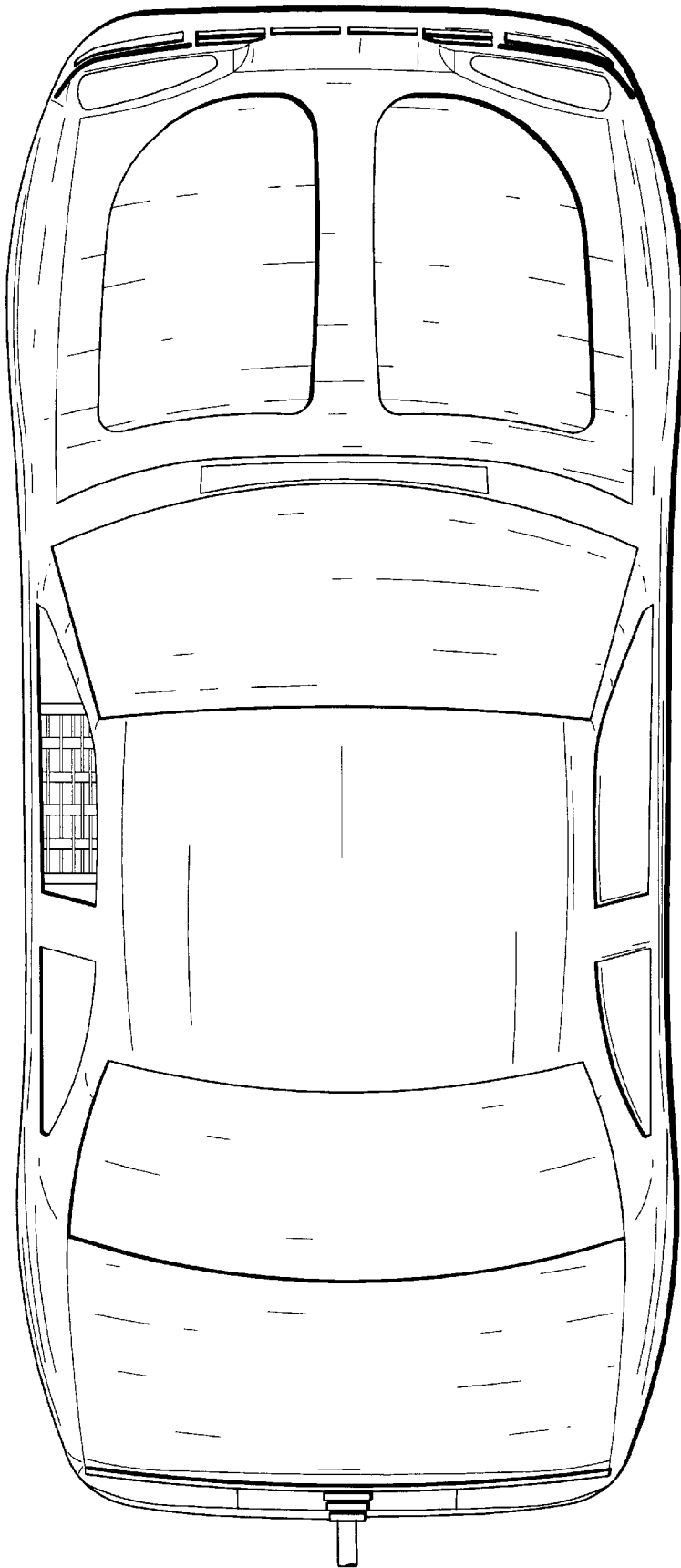

Fig. 4

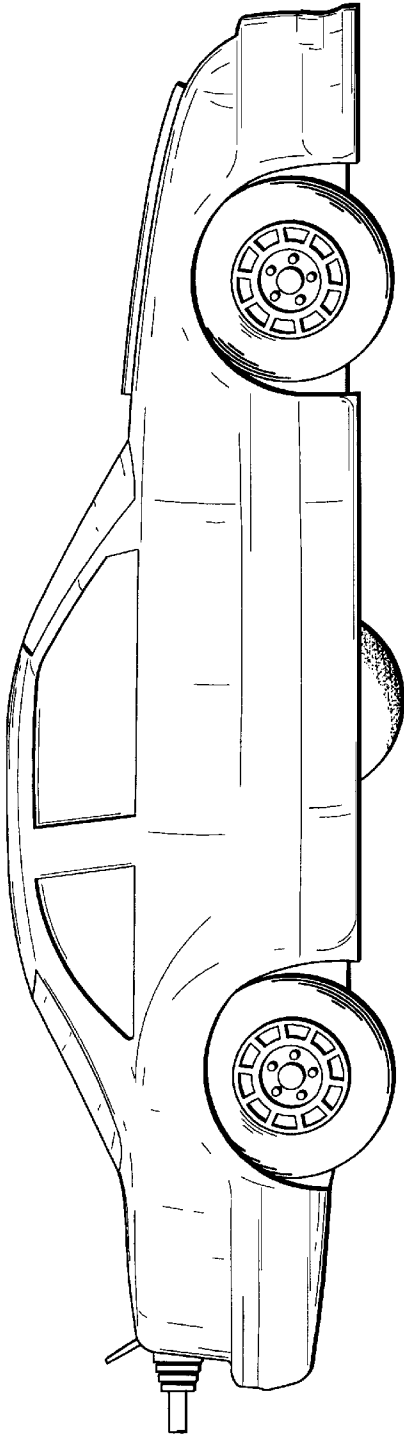

Fig. 5

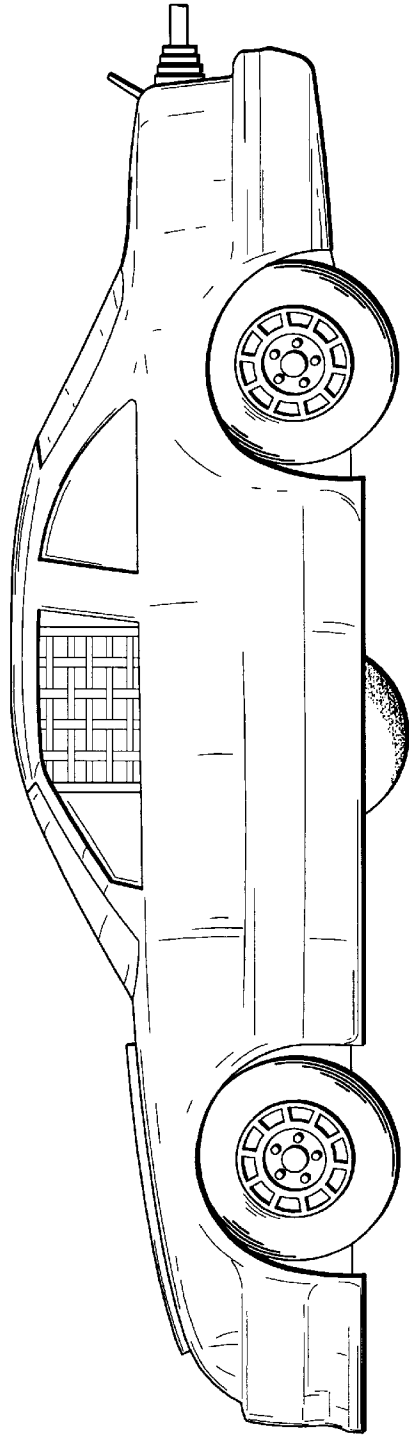

Fig. 6

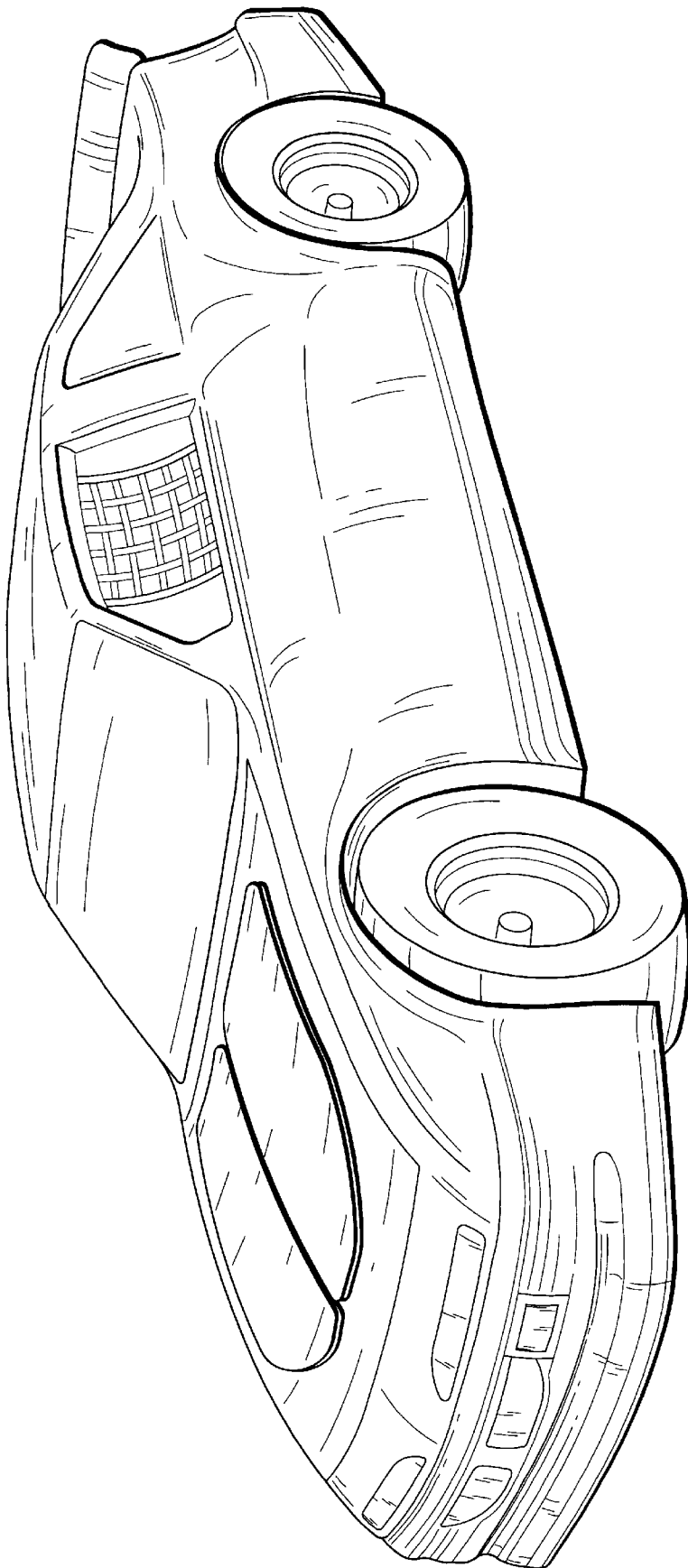

Fig. 7

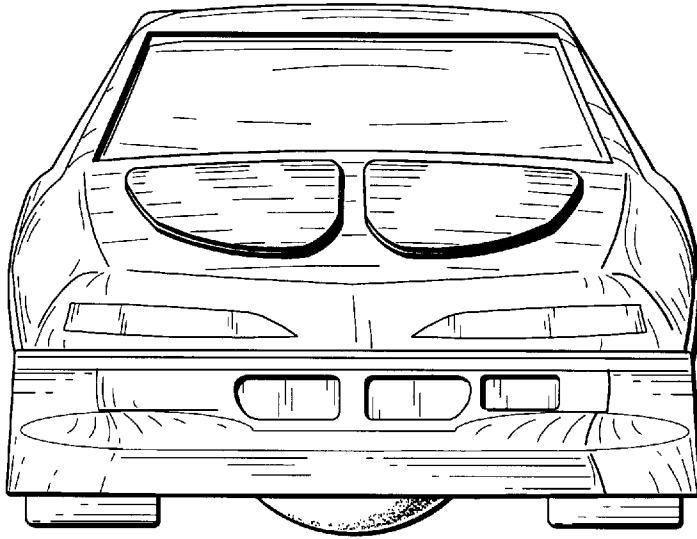

Fig. 8

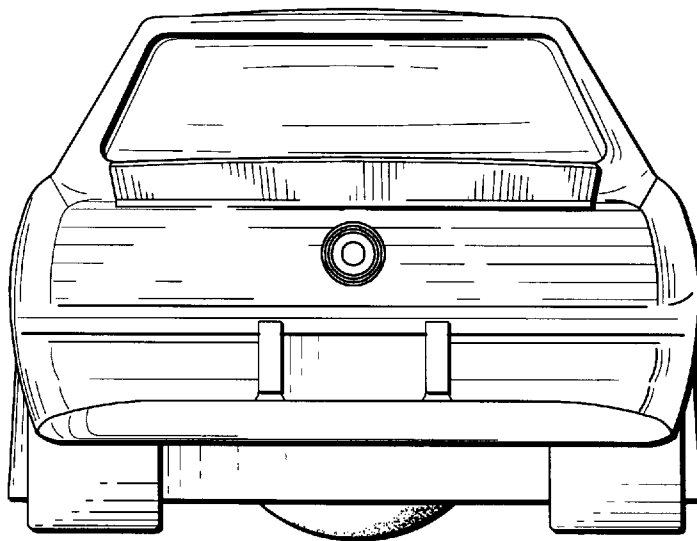

Fig. 9

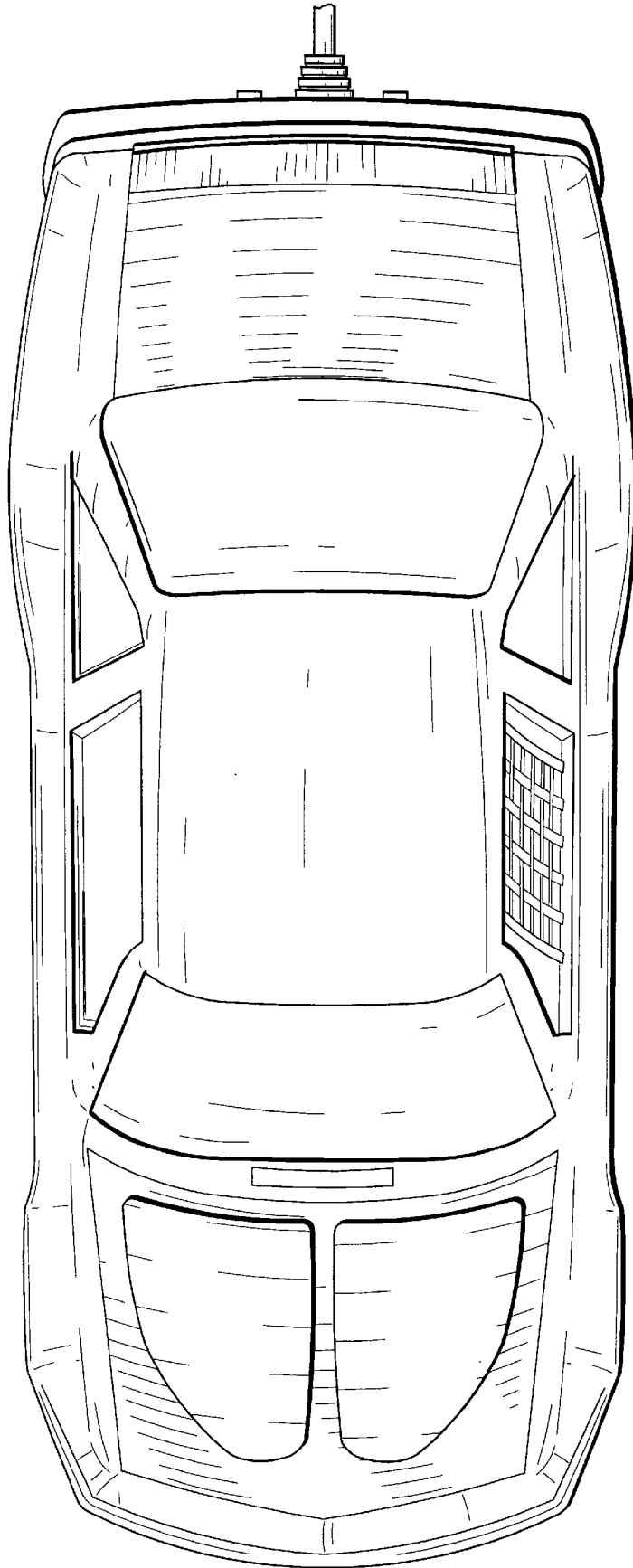

Fig. 10

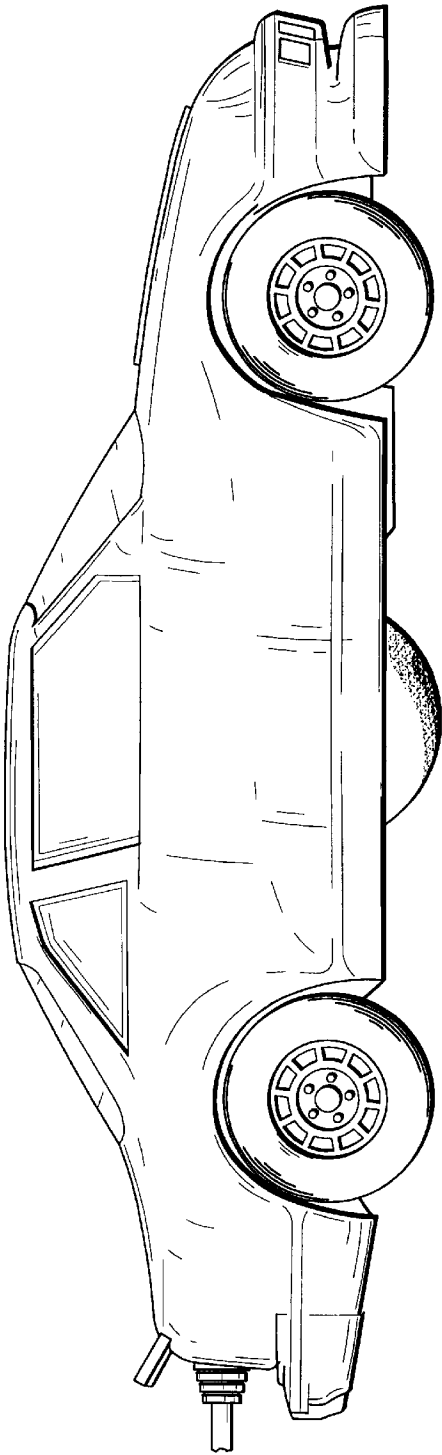

Fig. 11

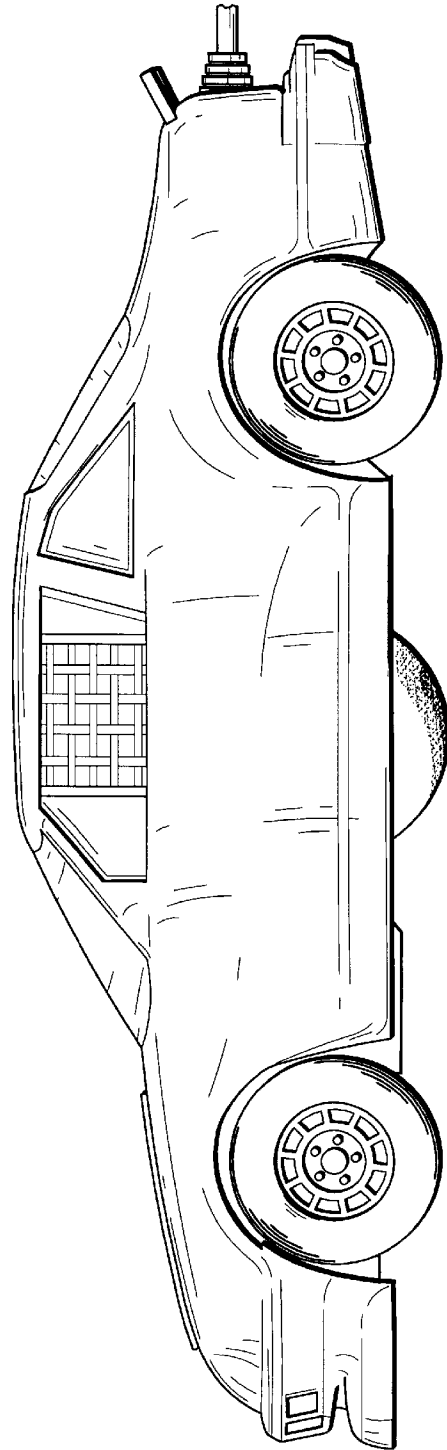

Fig. 12

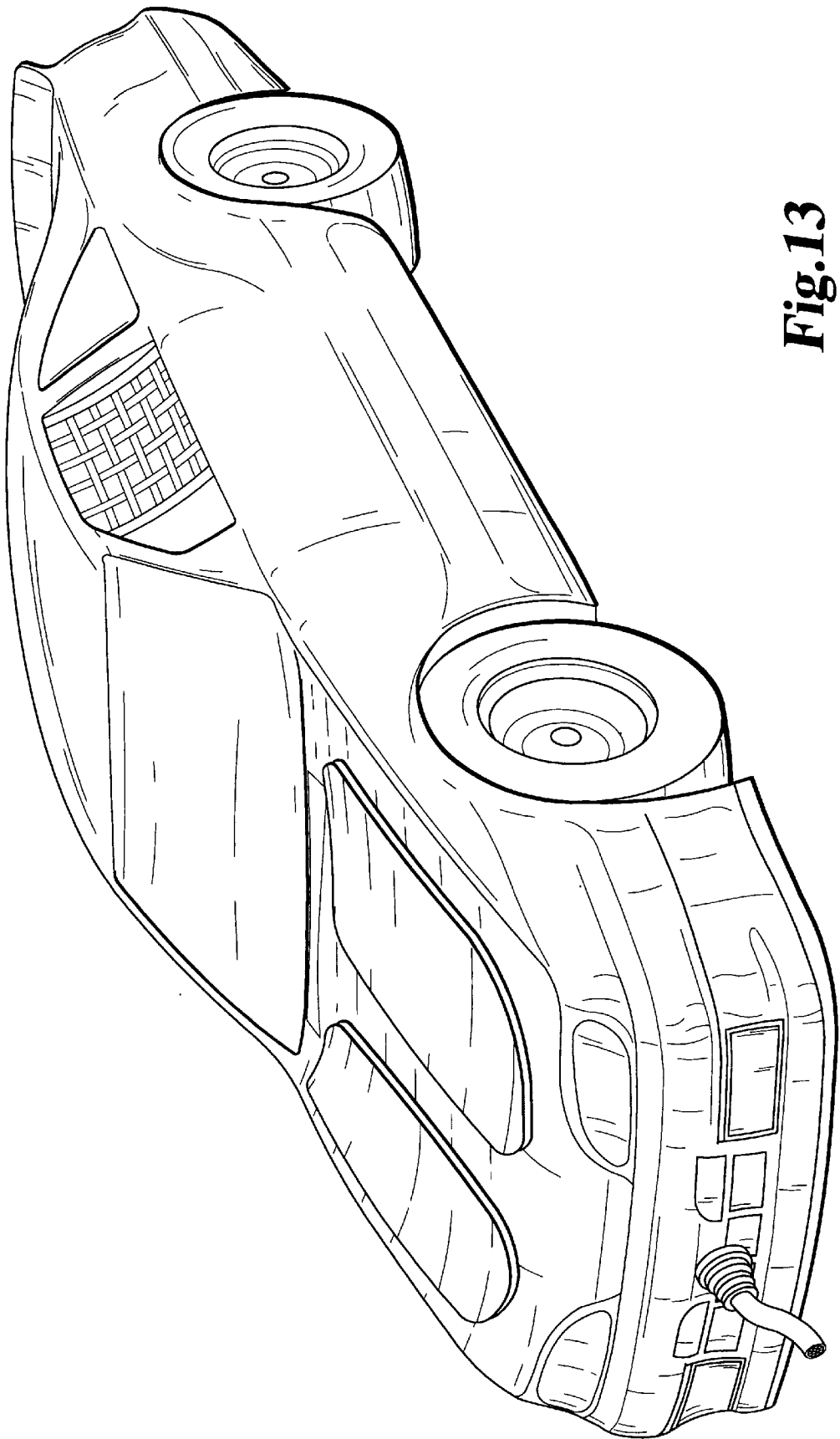

Fig. 13

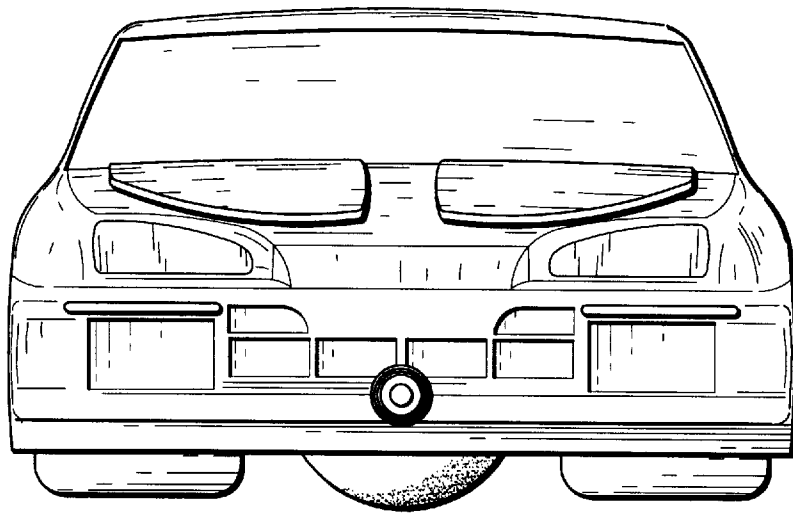

Fig. 14

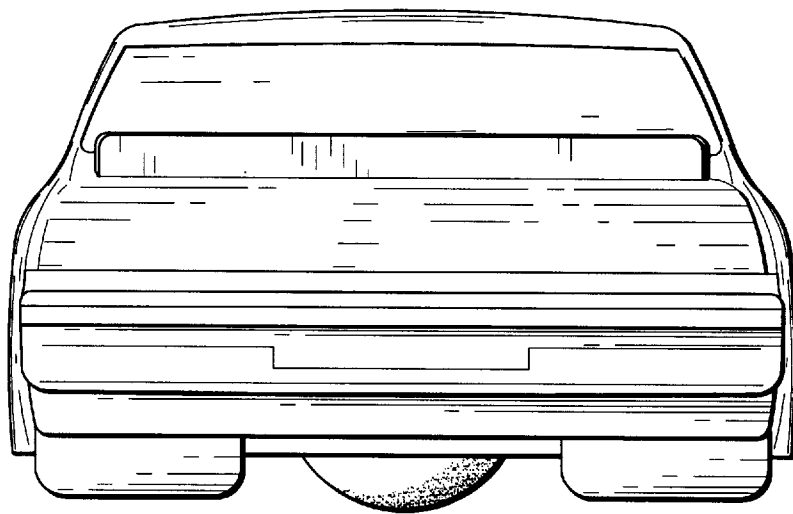

Fig. 15

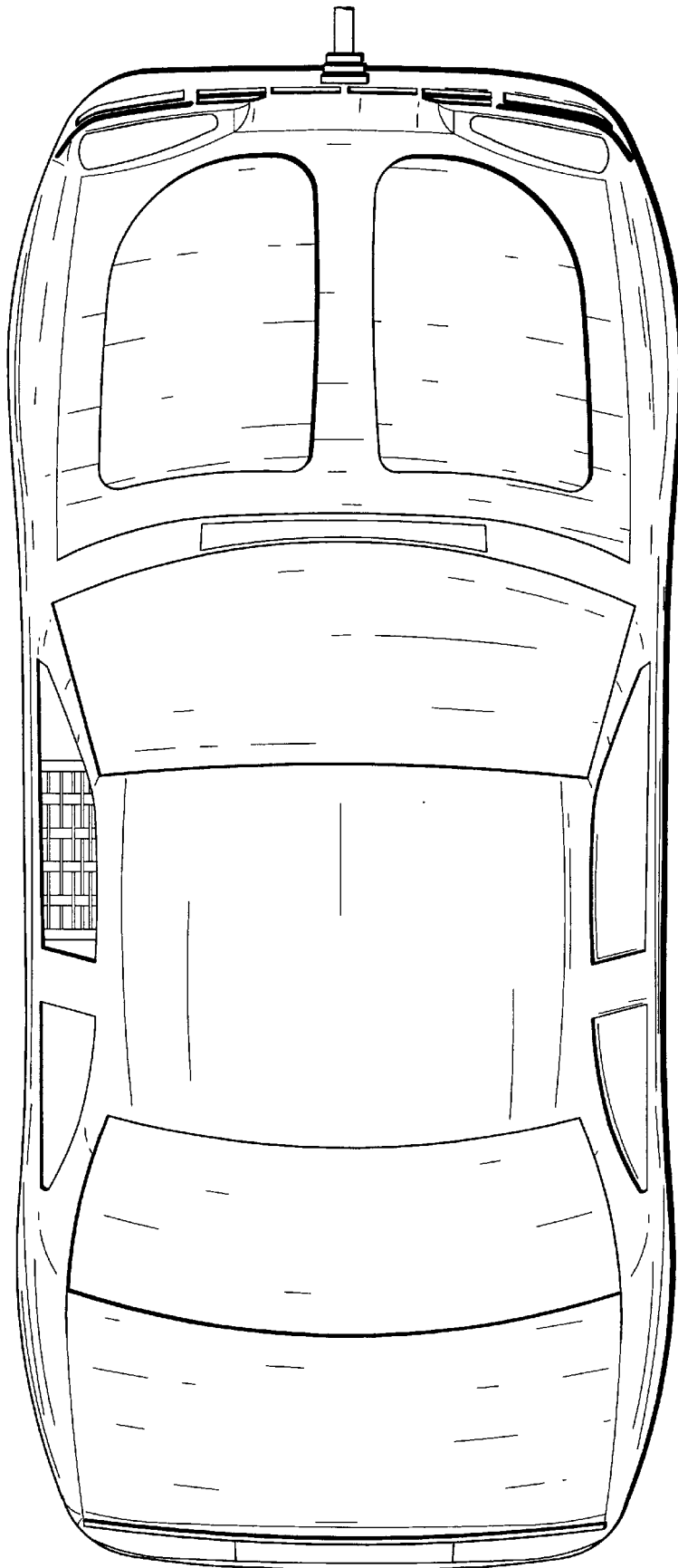

Fig. 16

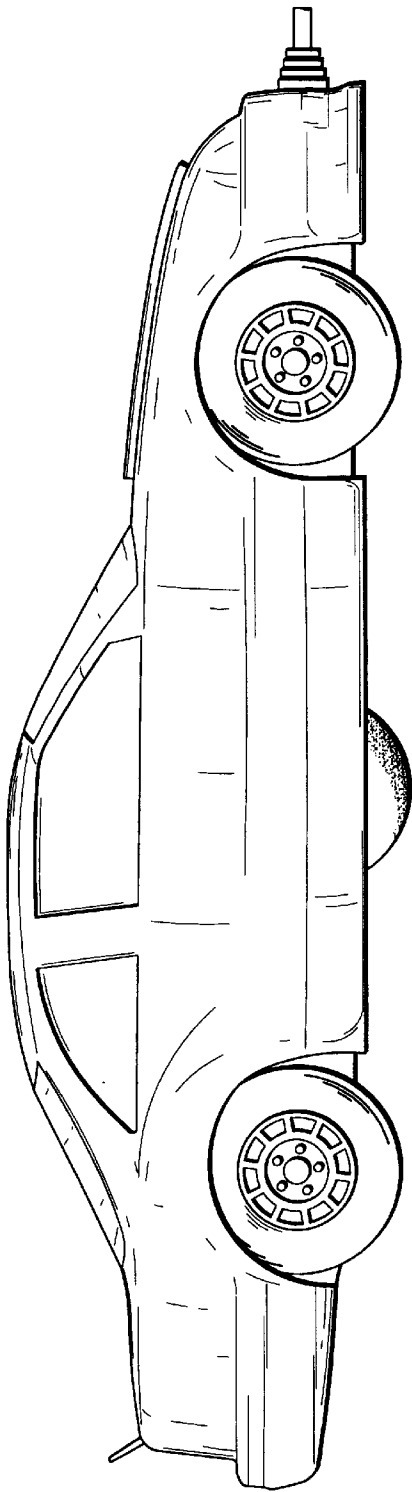

Fig. 17

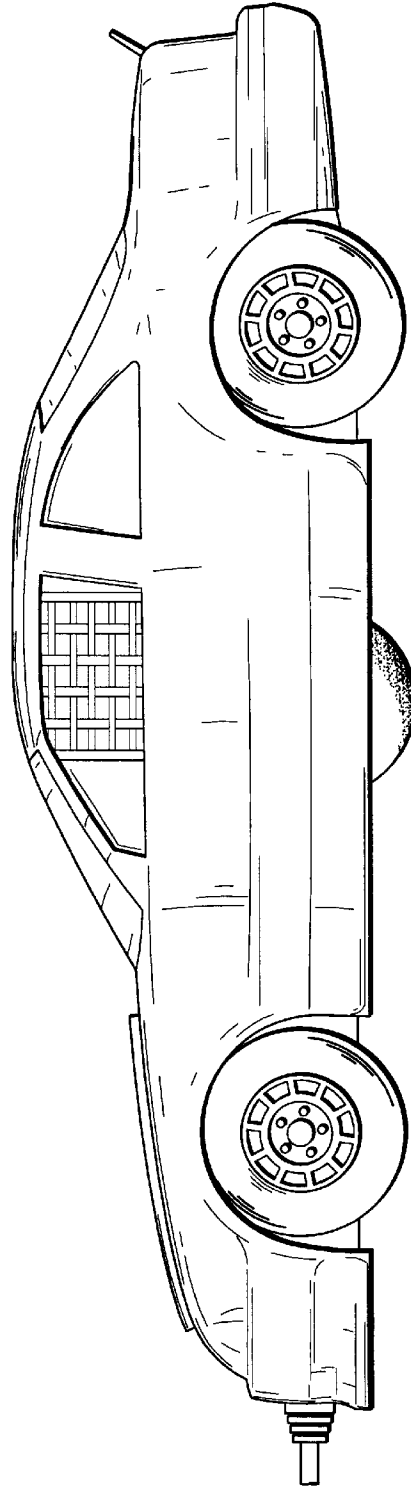

Fig. 18

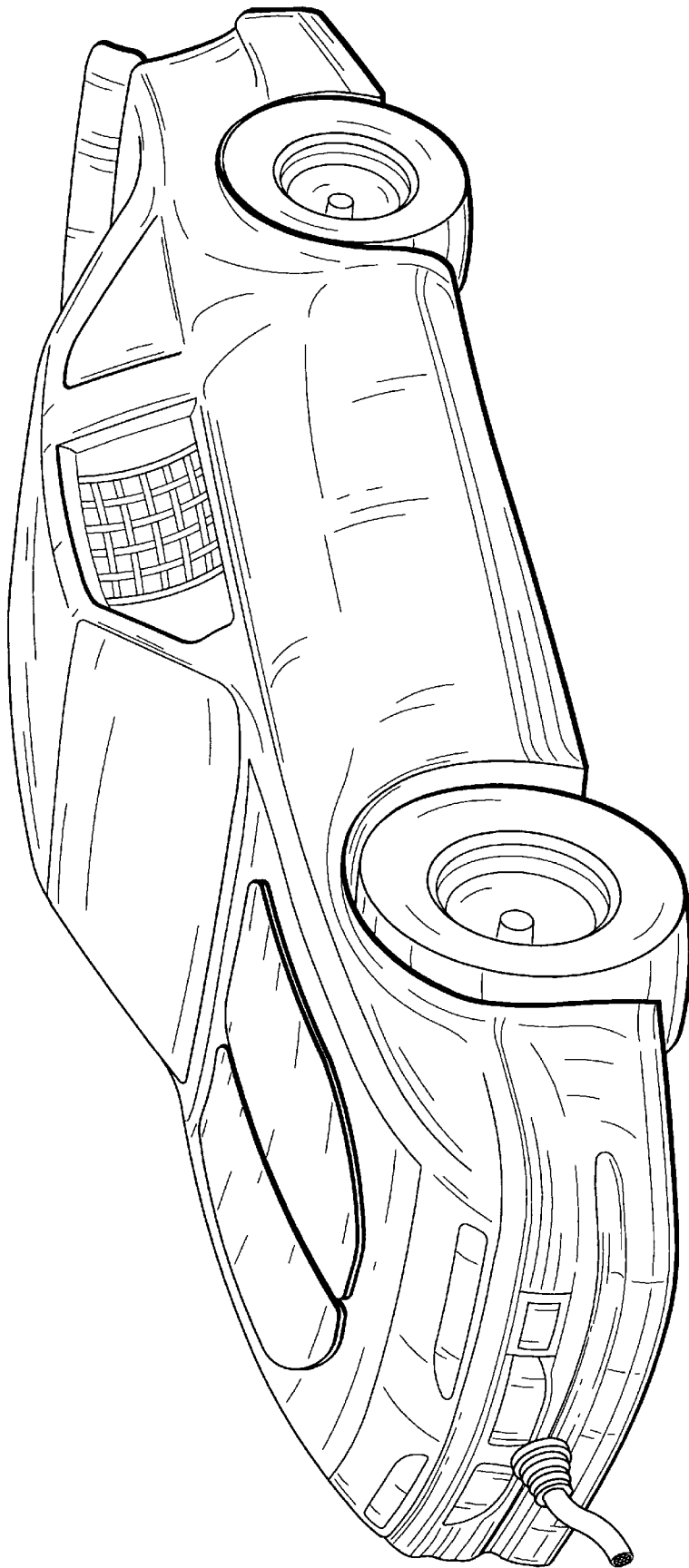

Fig. 19

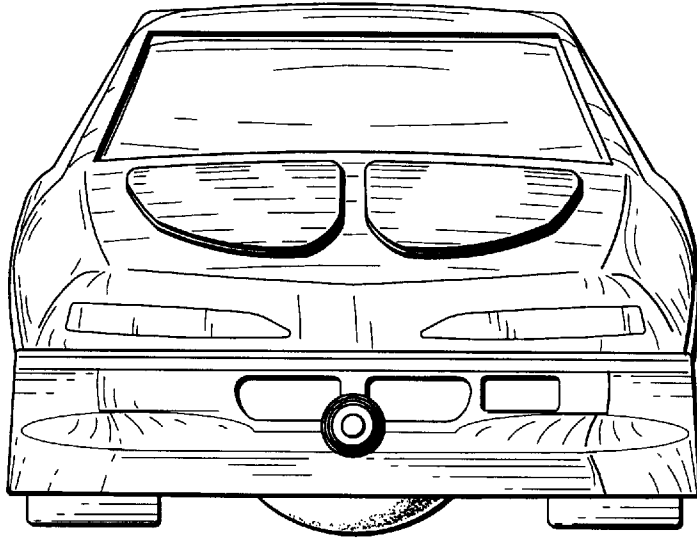

Fig. 20

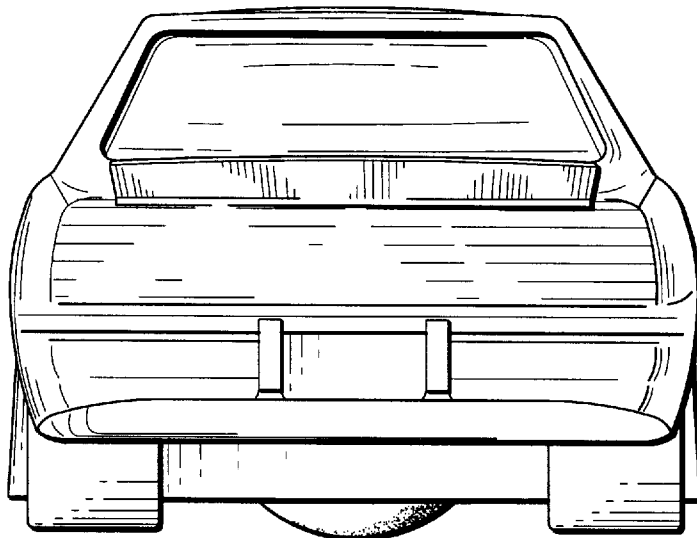

Fig. 21

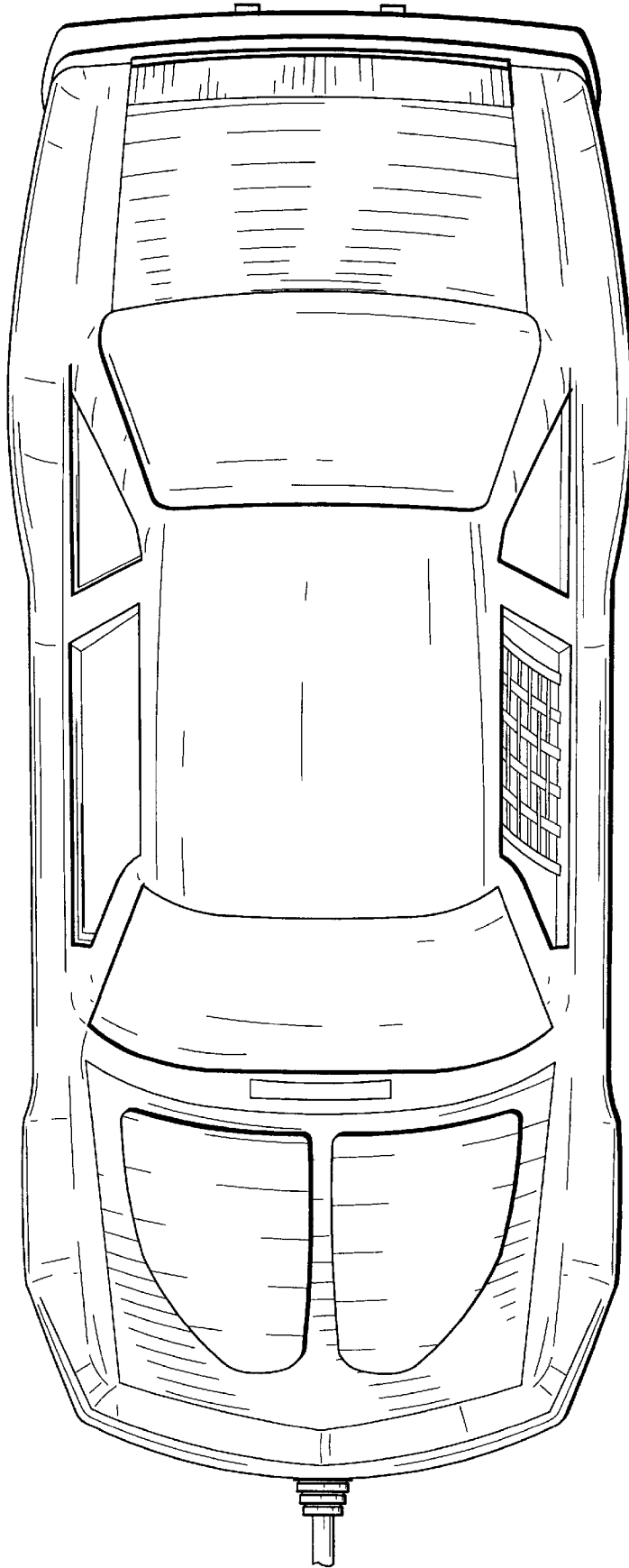

Fig. 22

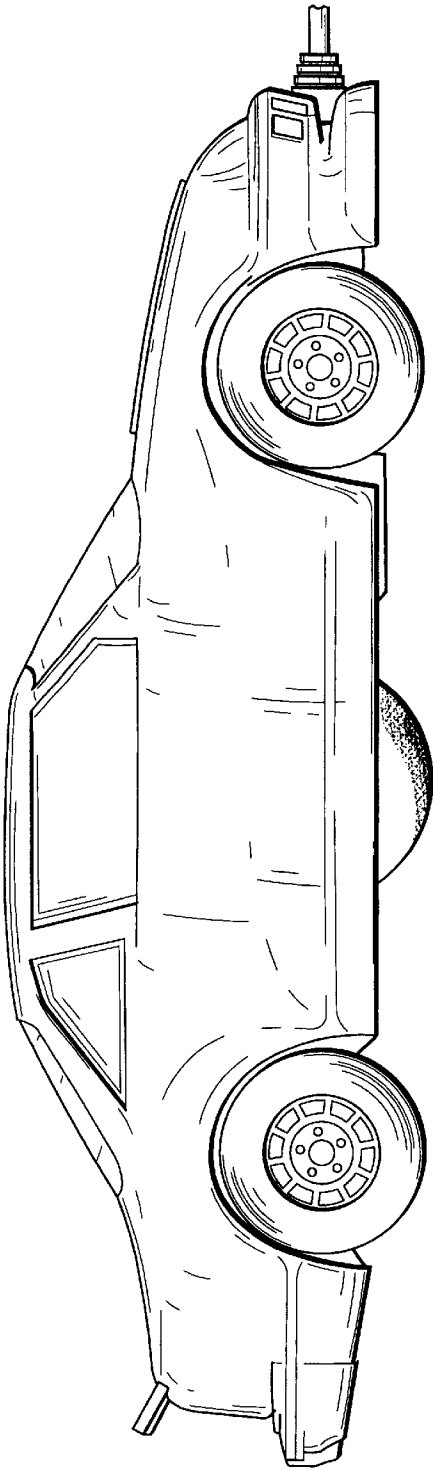

Fig. 23

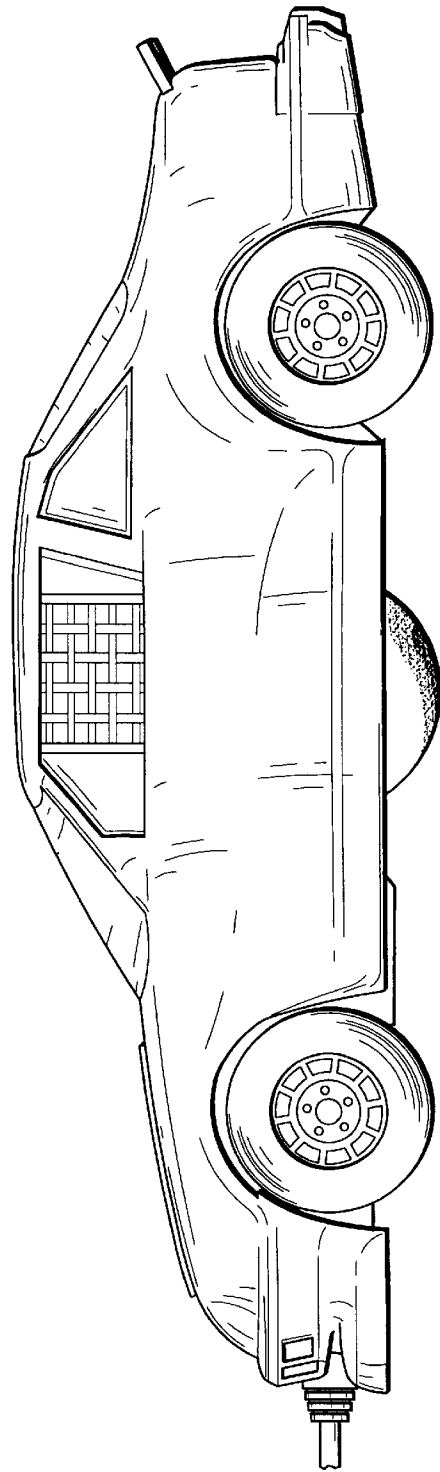

Fig. 24