



US00D901817S

(12) **United States Design Patent**
Li et al.

(10) **Patent No.:** **US D901,817 S**

(45) **Date of Patent:** **** Nov. 10, 2020**

(54) **CART**
(71) Applicant: **GUANGDONG WIREKING HOUSEWARES & HARDWARE CO., LTD**, Foshan (CN)

D831,390 S * 10/2018 Li D6/675.1
D832,549 S * 10/2018 Cao D34/21
D846,824 S * 4/2019 Cao D34/21
D846,825 S * 4/2019 Cao D34/21
D850,753 S * 6/2019 Cao D34/21
D852,448 S * 6/2019 Hu D34/12
D852,449 S * 6/2019 Hu D34/21
D858,928 S * 9/2019 Cao D34/21

(72) Inventors: **Xiaochun Li**, Foshan (CN); **Weitao Chen**, Foshan (CN)

(73) Assignee: **GUANGDONG WIREKING HOUSEWARES & HARDWARE CO., LTD**, Foshan (CN)

(**) Term: **15 Years**

(21) Appl. No.: **29/693,112**

(22) Filed: **May 30, 2019**

(30) **Foreign Application Priority Data**

Dec. 1, 2018 (CN) 2018 3 0690852

(51) **LOC (12) Cl.** **12-02**

(52) **U.S. Cl.**
USPC **D34/21**

(58) **Field of Classification Search**
USPC D34/12, 14, 17, 21
CPC A61G 12/001; B25H 3/06; B25H 3/021;
B25H 3/028; B25H 3/00; B62B 3/00;
B62B 3/002; B62B 3/005; B62B
2501/067

See application file for complete search history.

(56) **References Cited**

U.S. PATENT DOCUMENTS

D207,308 S * 4/1967 Bell D34/21
D436,239 S * 1/2001 Walsh D34/17
D752,906 S * 4/2016 Gunderson D6/675.1
D756,584 S * 5/2016 Dunford D34/12
D757,387 S * 5/2016 Cao D34/21

OTHER PUBLICATIONS

Google search Aug. 25, 2020, Wholesales 4 tier utility rolling cart, Storage Rack Storage Holders, View Storage Holders, Product Details from Guangdong Wireking Housewares and Hardware Co., Ltd. on Alibaba.com (Year: 2020).
Google search Aug. 25, 2020, Amazon.com, KINGRACK 3 tier storage rolling cart, <https://www.amazon.com/KINGRACK-Storage-Rolling-Pegboard-Organizer/dp/B07X2CGCN1> (Year: 2020).*

* cited by examiner

Primary Examiner — Cynthia Ramirez

(57) **CLAIM**

The ornamental design for a cart, as shown and described.

DESCRIPTION

FIG. 1 is a perspective view of the cart shoeing my new design;
FIG. 2 is another perspective view thereof;
FIG. 3 is a front elevational view thereof;
FIG. 4 is a rear elevational view thereof;
FIG. 5 is a left side elevational view thereof;
FIG. 6 is a right side elevational view thereof;
FIG. 7 is a top plan view thereof;
FIG. 8 is a bottom plan view thereof;
FIG. 9 is an enlarged partial view of portion 9 of FIG. 1; and
FIG. 10 is an enlarged partial view of portion 10 of FIG. 1.
The broken lines in the drawings depict portions of the cart that form no part of the claimed design.

1 Claim, 10 Drawing Sheets

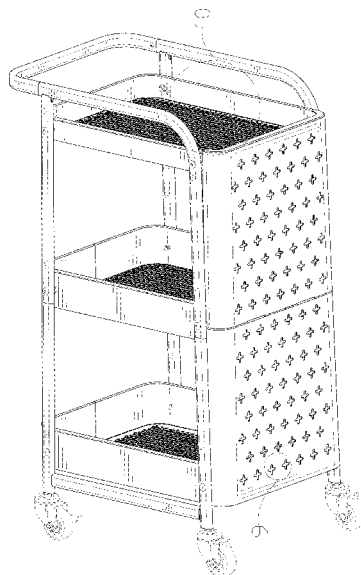

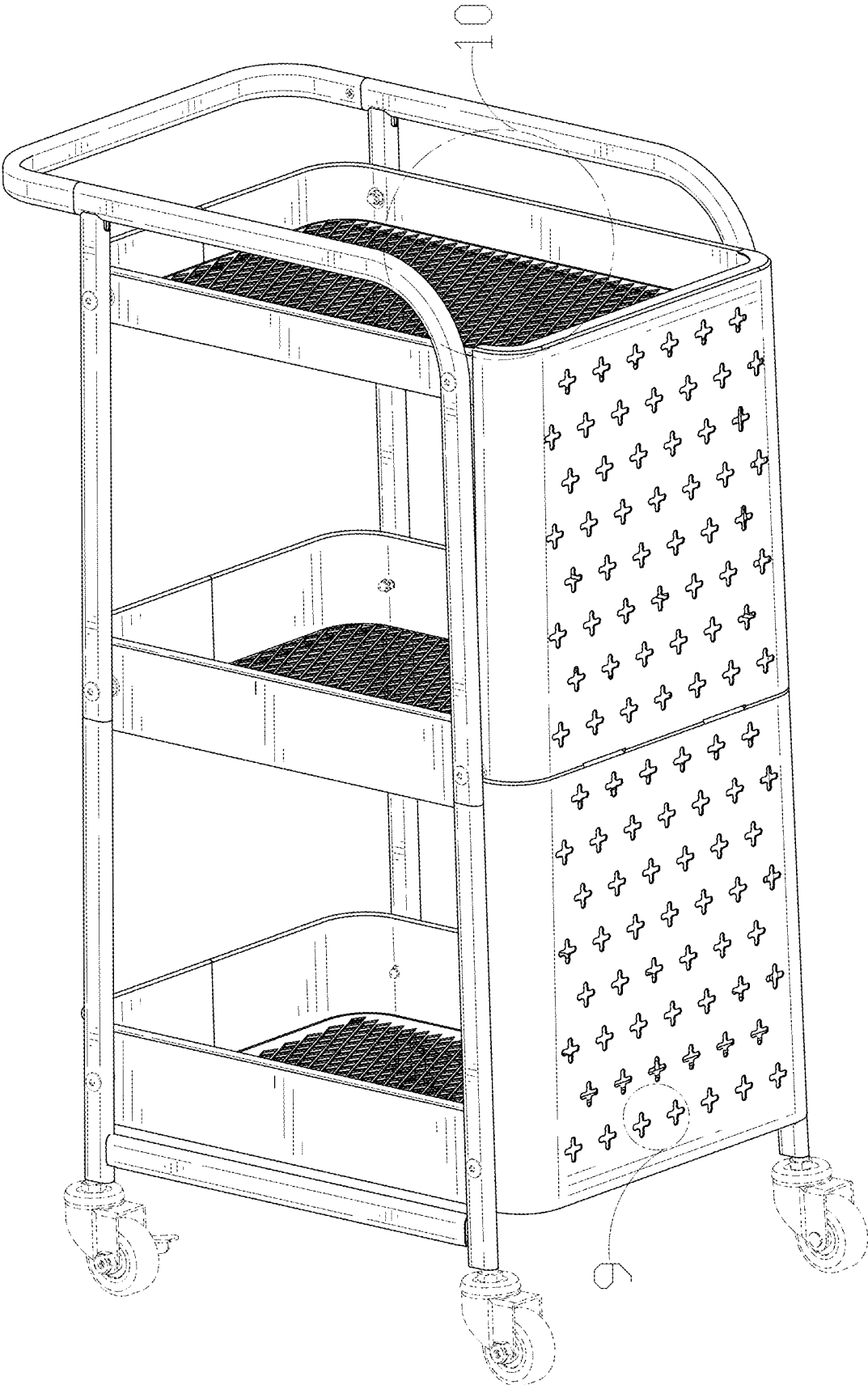

FIG. 1

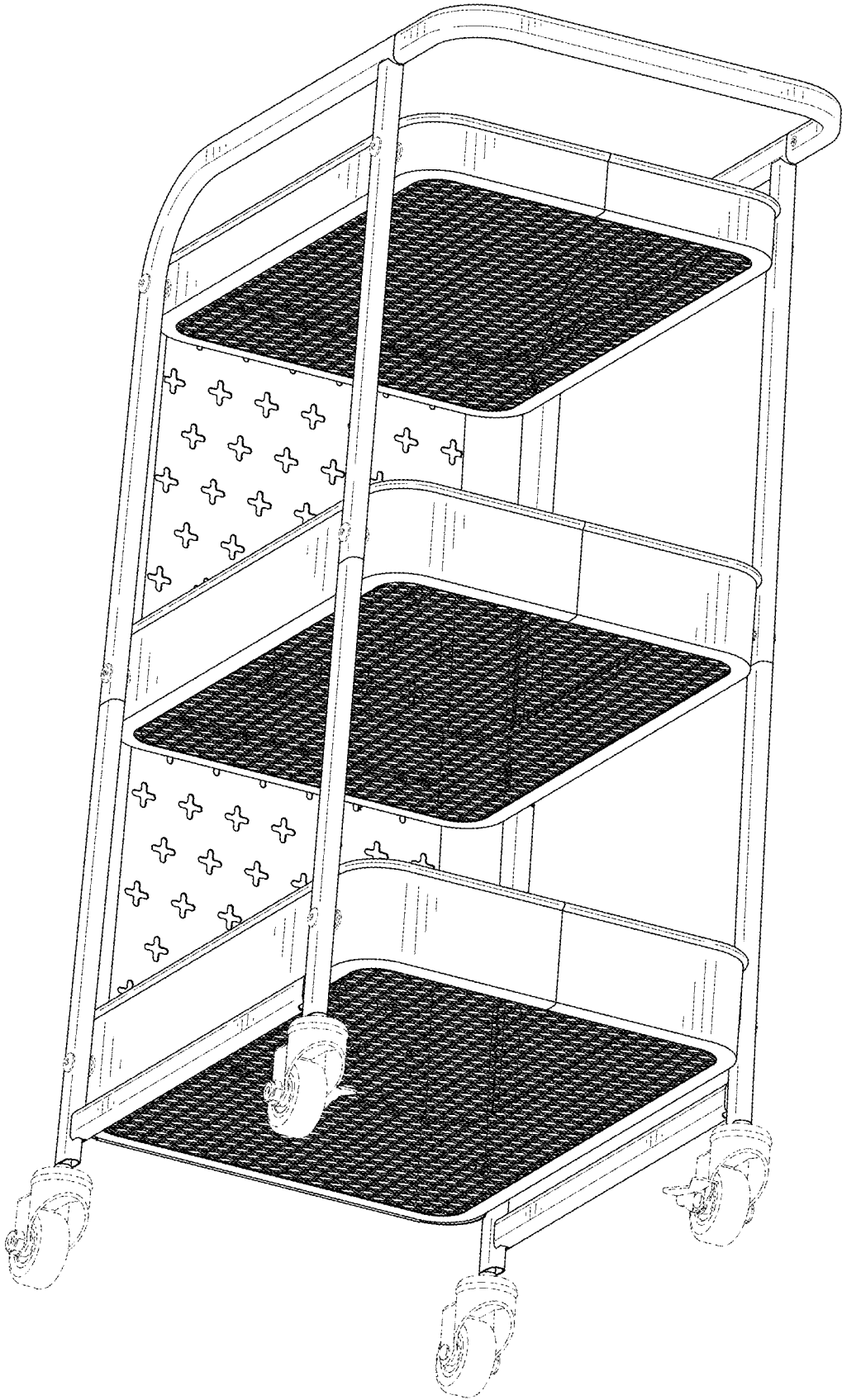

FIG. 2

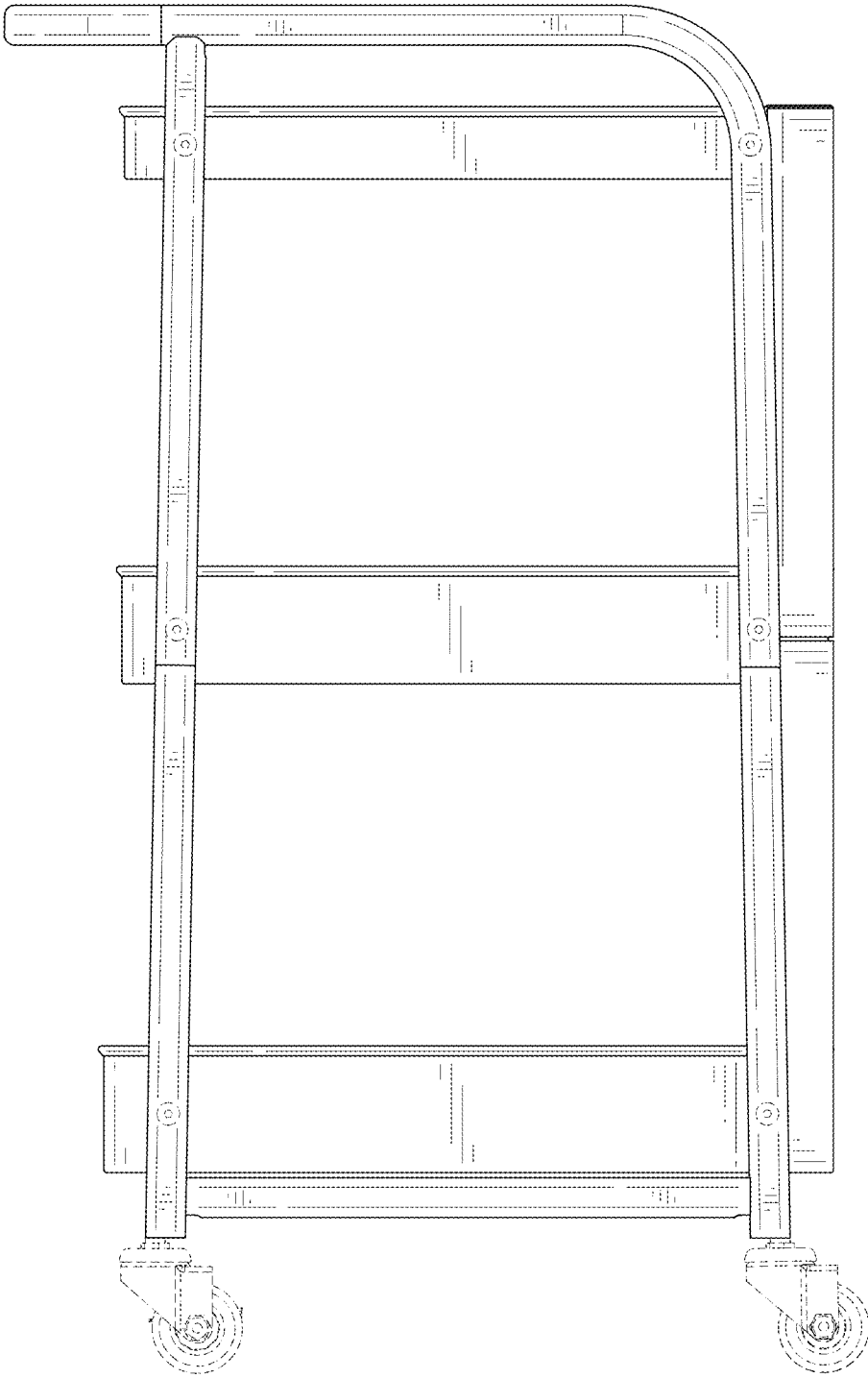

FIG. 3

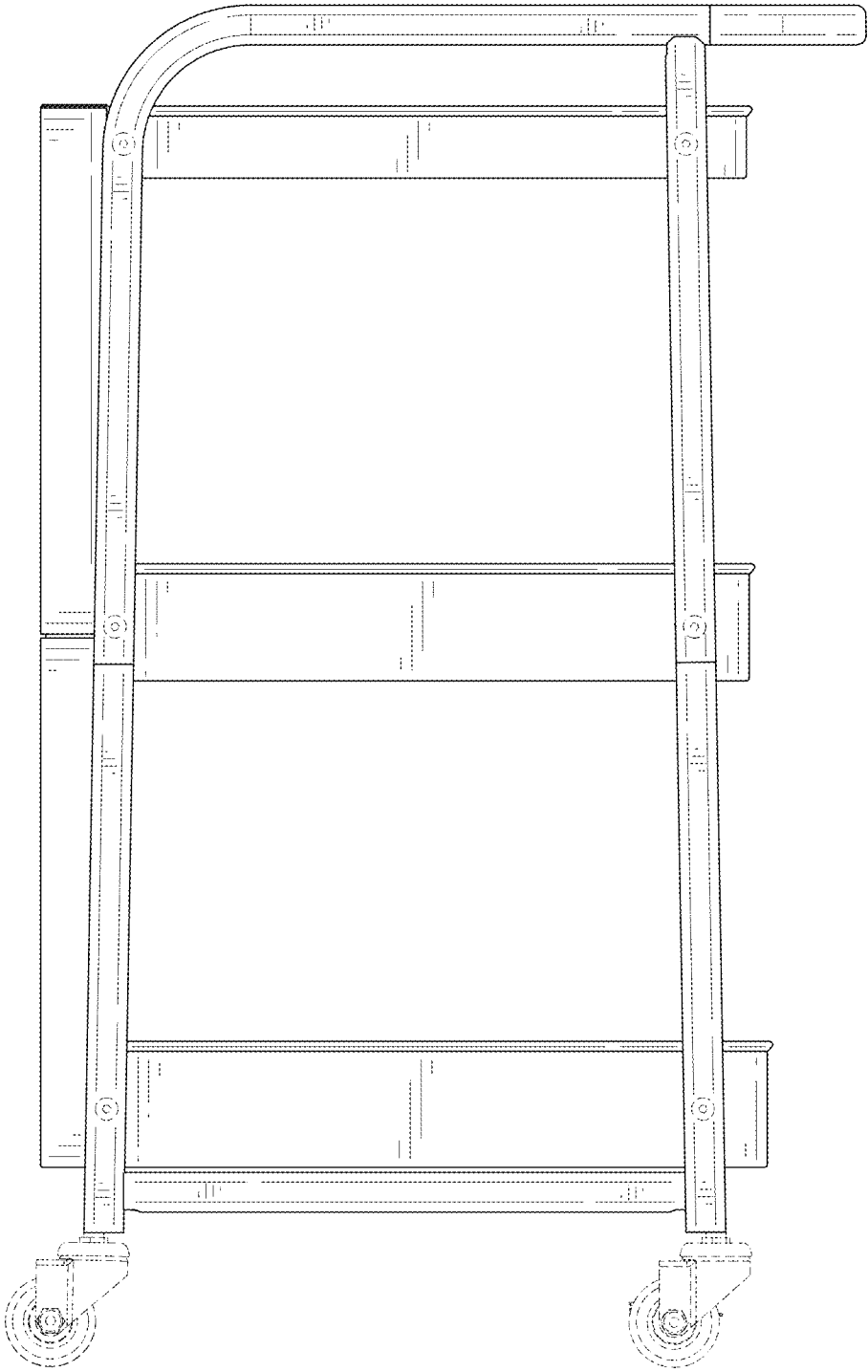

FIG. 4

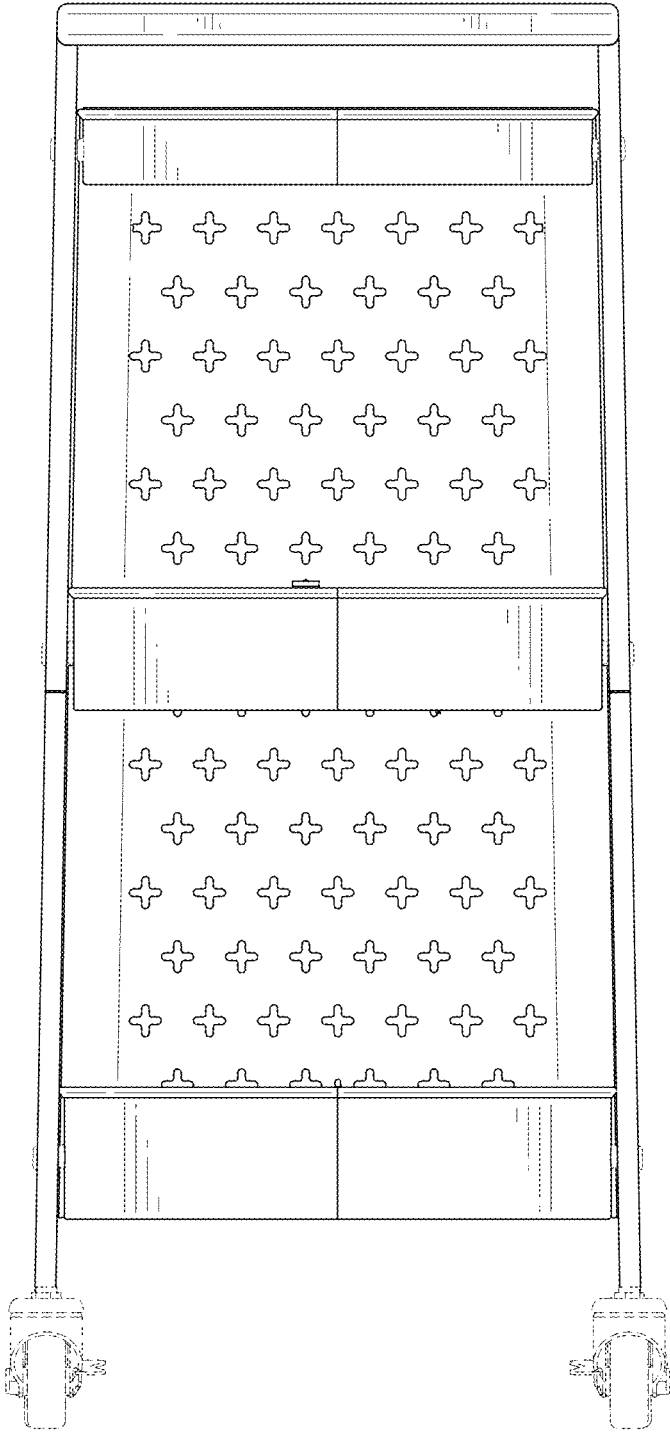

FIG. 5

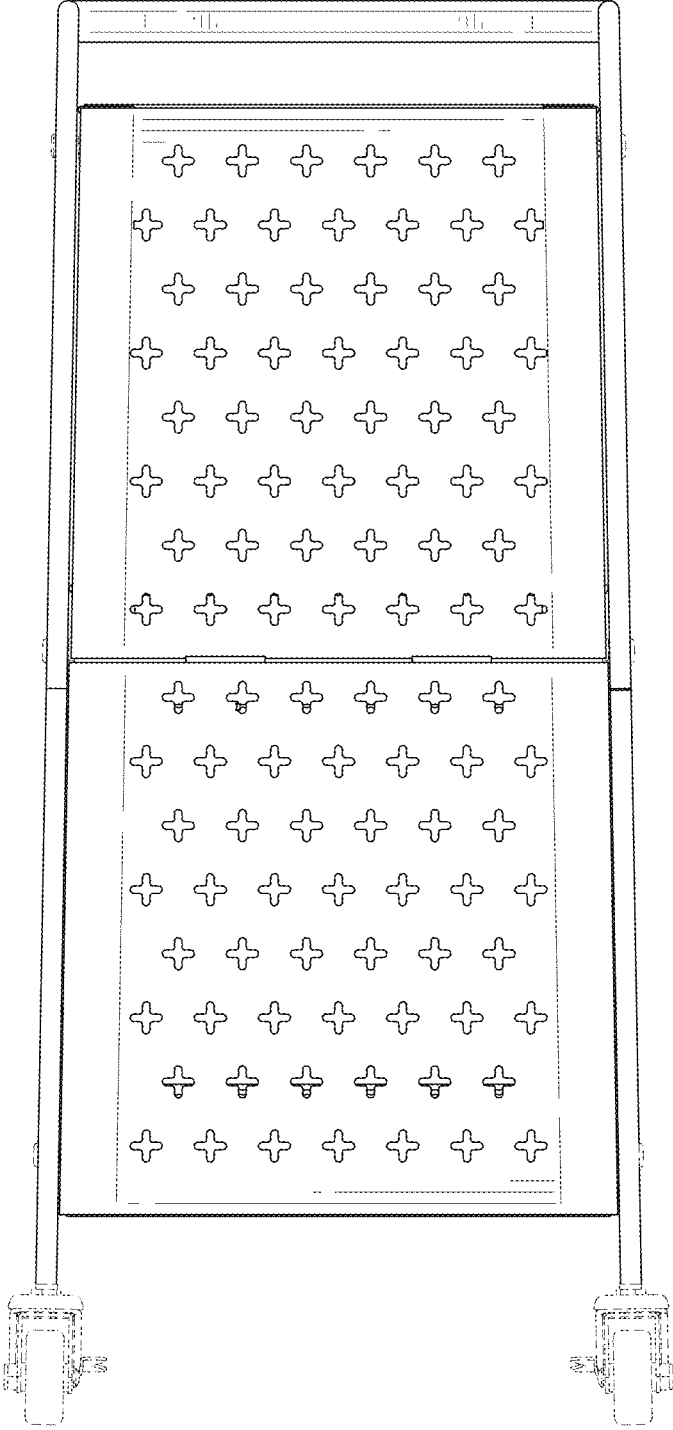

FIG. 6

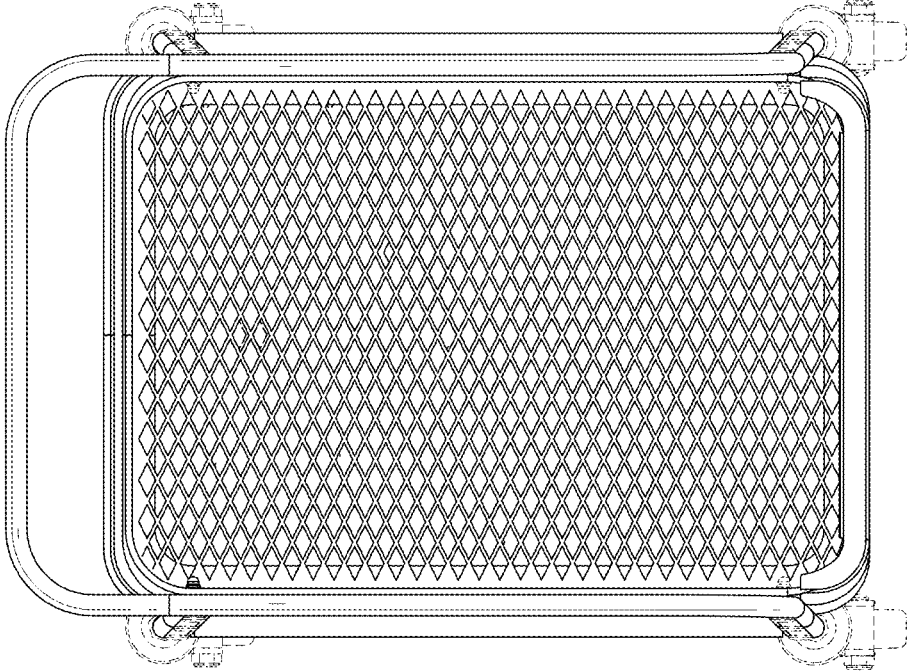

FIG. 7

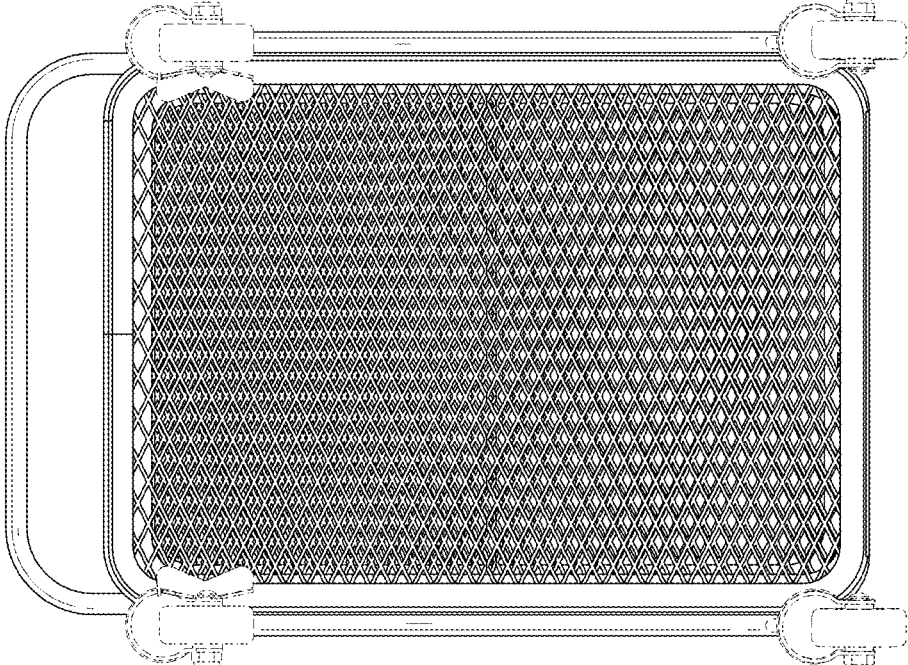

FIG. 8

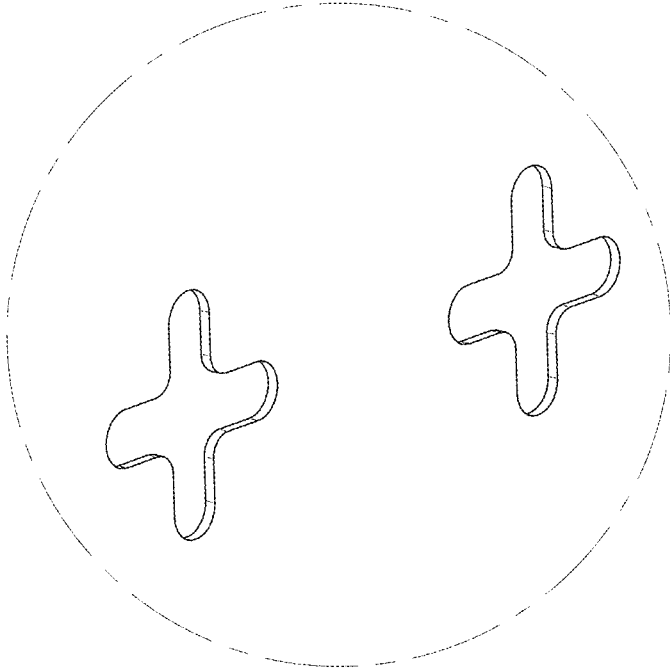

FIG. 9

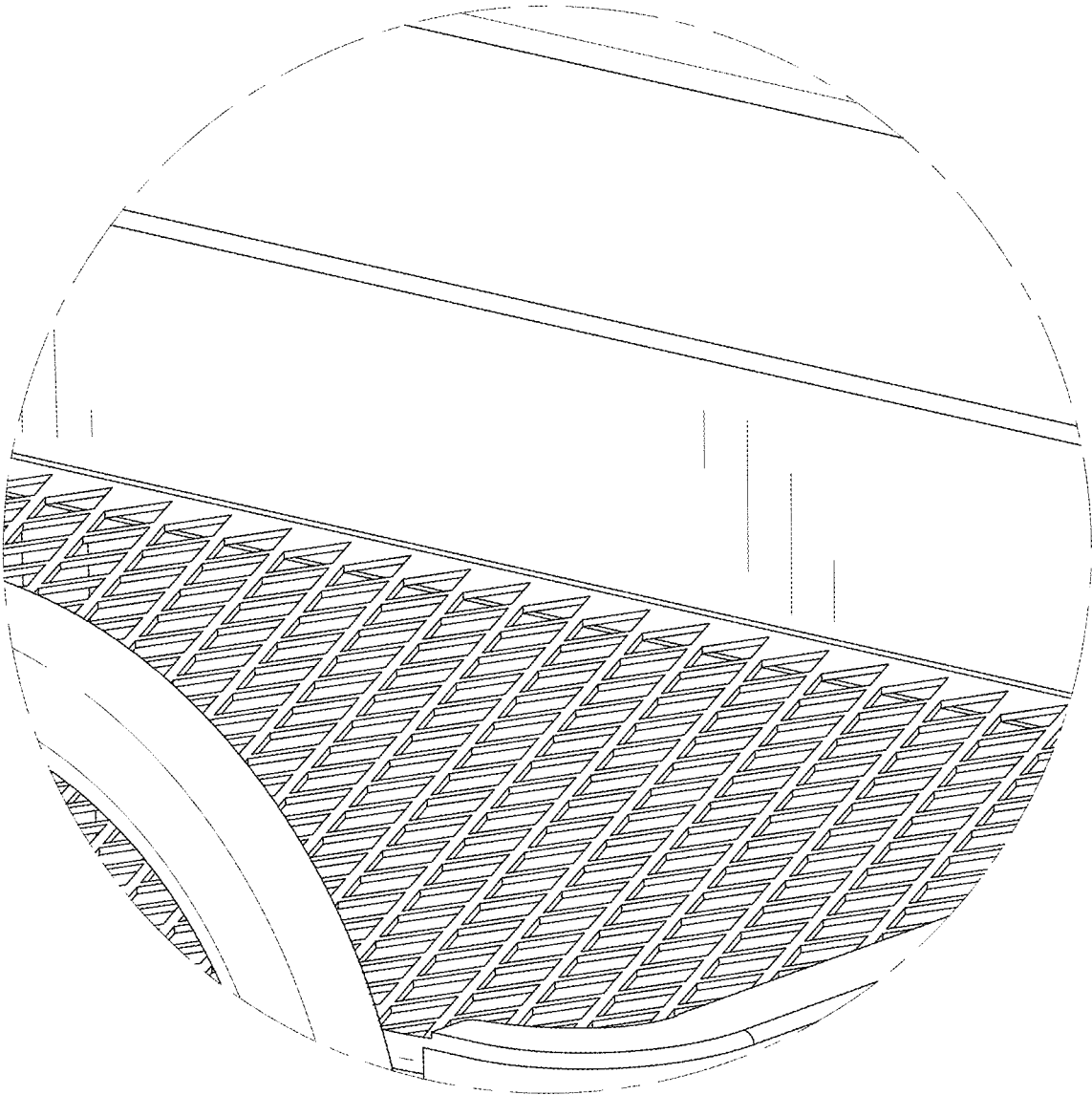

FIG. 10